



ILLUSTRATED LESSON NOTES FOR TEACHERS

INTRODUCTION

preamble for all lessons

1) cityscape

2) cityscape up

3) cityscape down

4) room interior two point

5) railway

6) room interior CVP

6b) room interior cont.

7) letters

8) shadows basic

9) shadows 2

10) archway

10b) completed arch

11) road

11b) road continued

12) book

12b) book continued

PART TWO INTRODUCTION

1) 'quick sketch page'

2) methods of shading

3) tennis and shadows

4) reference sheet

5) in three dimensions

6) a 'fork' in the road

7) portraiture

8) portraiture cont.

9) drawing roses

[Send me a short message](#) with the phrase "please e-mail" if you'd like to read news of new free drawing lessons as they occur and as the pages are updated (no more often than weekly!) **NEW** [John Hagan CD now available!](#) , **[COWDISLEY HOME SITE](#)**

[Peek into a corner of the John Hagan studio ...!](#)

WWW.MLFORUMS.COM

4 more info



LESSON NOTES FOR TEACHERS

LEARN HOW TO DRAW Essential and elementary lessons on learning how to draw for 9-14 year olds who have interests in becoming;

Artists,
Architects,
Video game designers,
Cartoon artists,
Special effects artists,
Interior Designers,
Draughtsmen,
Fashion Designers,
Surveyors, Engineers, Builders,
Illustrators,
Graphic designers,
Computer designers,
Set designers for film, opera, ballet, stage etc.

Time - Lessons are separated into approx. 40 min segments.

Homestudy - 10 to 20 minutes per lesson - set work proposals suggested at end of each lesson.

Materials:

30x45cms or 12"x18" standard cartridge paper (thick, white, plain) sketchpad.
2H, HB and 4B pencils
Ruler and eraser

General lesson structure:

5-10 min. revision and homework assessment.
5 min. new page, draw margin and add title (bottom rh corner).
20 min. demo and child practical drawing.
5 min. summary and suggested homework.

NOTES

*These lessons are designed using basic skills already learned by students; to measure and to draw straight lines using a ruler. Elements of self-expression are based on familiarity and habit and will come gradually - particularly when the student grows comfortable with the lesson structure. Such self-expression is first emphasised in the homestudy area.

*The second part of the lessons will deal with the freehand elements of drawing but it has been my experience that these freehand lessons come easier with confidence, enthusiasm, discipline and a general understanding of the principles of perspective and the drawing of regular solids. For those who think good drawing has nothing to do with the understanding of basic structure need not read much further. Be warned that it is my way to teach that basic structure first.

*If the lessons are conducted as I have designed them the teacher will find most children will tend to neglect more formal homework and concentrate on expressing themselves by completing their drawings in their own time. I have taught these lessons to all ages including disturbed children, intelligent young adults, three different cultures, and to individuals completely disinterested in education generally. The end results were universal, the students became more perceptive and desired a career change. Be prepared to be besieged by parents at parent teacher nights.

The Classroom teacher needs a good clean chalkboard, white chalk and a long straight edge (a board tee square for the less adept). The home educator needs the same equipment as the student.



[GO TO ... PREAMBLE LESSON](#)



ALL LESSONS - THE PREAMBLE

Lesson preamble - Pencil control for the start of all lessons

Aim: To teach the importance of eye to hand coordination, pencil control.

Materials:

the sketch pad,
the HB pencil,
ruler.

PENCIL CONTROL

A) The pupil will be asked to rule a light horizontal line 1cm or 1/2 inch from the top of the page. The word **lightly** must be stressed and the student's task will be to draw the line so it is visible at half a meter but **invisible at a meter**.

B) Have the student hold these up and the teacher will discover that only one or two students will be able to achieve this result. Praise those two and demonstrate to the whole class the correct method of holding a pencil for a long light line is to drag the pencil across the page lightly holding it between thumb and index finger. The trick is to move your **ARM** and shoulder and not your fingers!

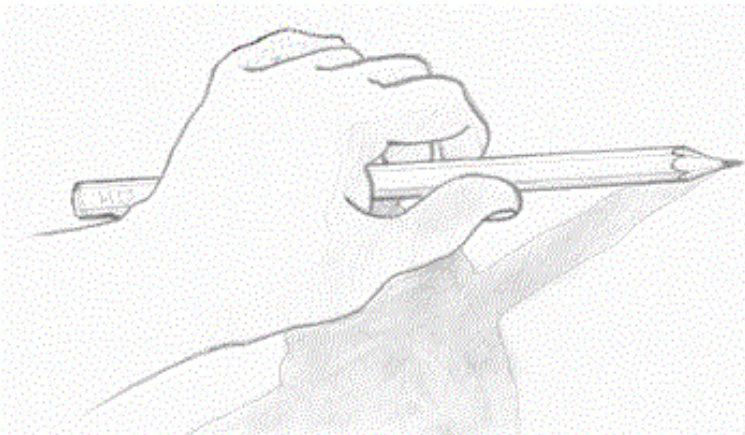

C) Have the class draw a light line across the bottom of the page using this technique and get their next-door neighbour to check it for visibility at a yard.

D) If this proves satisfactory have the student complete the verticals two vertices in the same manner.

E) Hold these up for inspection and then ask the students to firm in the margin with their pencil leaving the corners so they can discern the difference between their light and heavy lines.

F) Lightly construct a little box 2cmx6cm (1" x2") in the bottom right hand corner for a title, then firm it in as shown below.

<div data-bbox="671 465 804 506" data-label="Text"><p>TITLE - NAME</p></div>
--

This exercise is to be done at the beginning of every drawing class for every page as it slots the students mind into line control (allow 5 min. maximum).



[GO TO ... LESSON ONE](#)

[or ... lesson menu](#)



LESSON ONE - ELEMENTARY PERSPECTIVE

TIME: Allow one hour for this initial lesson - if combined with previous lesson 80min. It is strongly suggested the teacher prepares by completing the lesson sometime before attempting to teach. Particular measurements can then be given to those who need them.

Aim: To introduce the student to the notion of creating a three dimensional vista on a two dimensional plane. This lesson is particularly important as its intent is have the student create a picture of great depth by merely copying the lines the teacher makes on the chalkboard. The aim is to generally promote confidence in the student.

Materials; The sketch pad,
HB pencil, ruler.

We will carry on from the page prepared in the preamble lesson using the ruler and HB pencil ...

a) Quarter the page as shown with light lines. Teacher should do this on the chalkboard, then wait for the students to catch up.

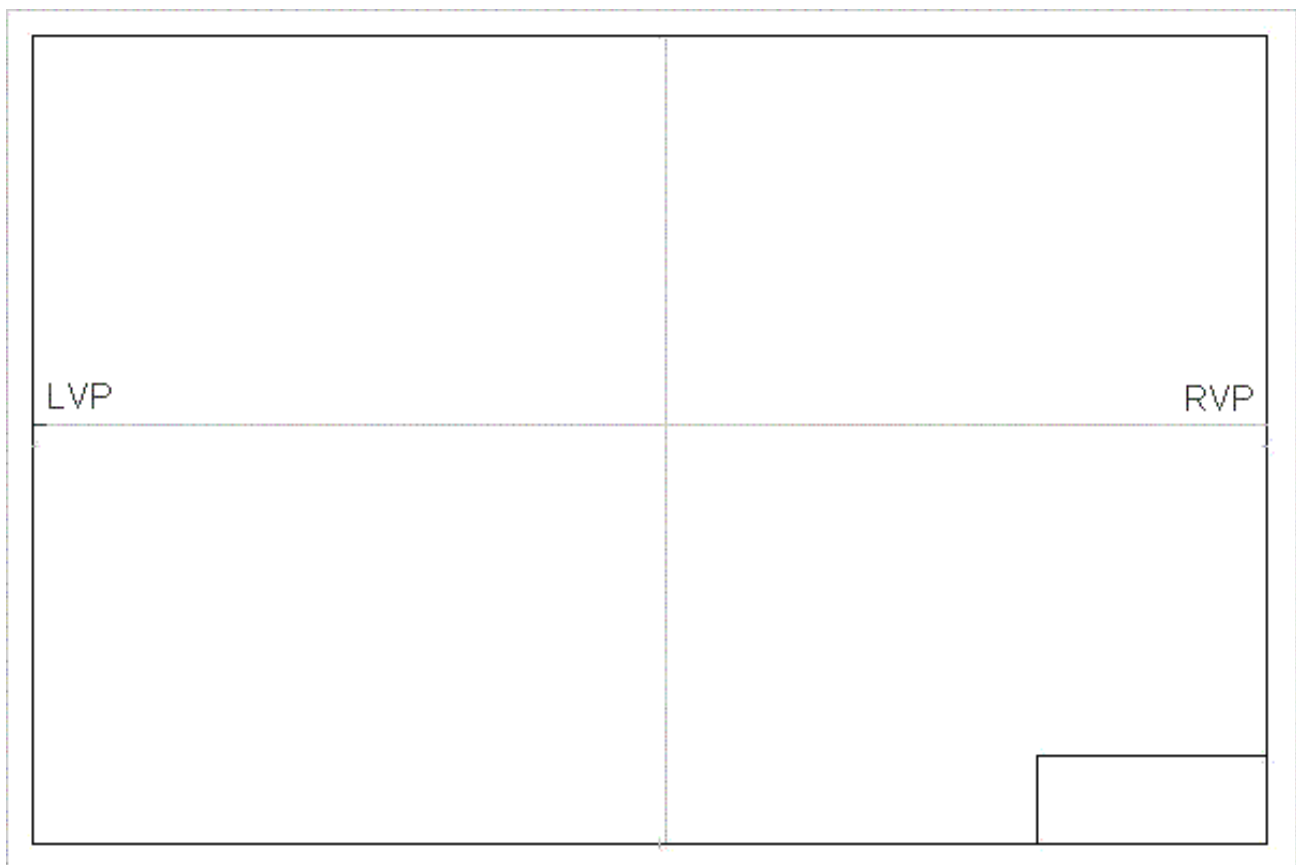

b) Where the middle line touches the border mark two points - these are called ... RVP and LVP (Right and Left Vanishing Points).

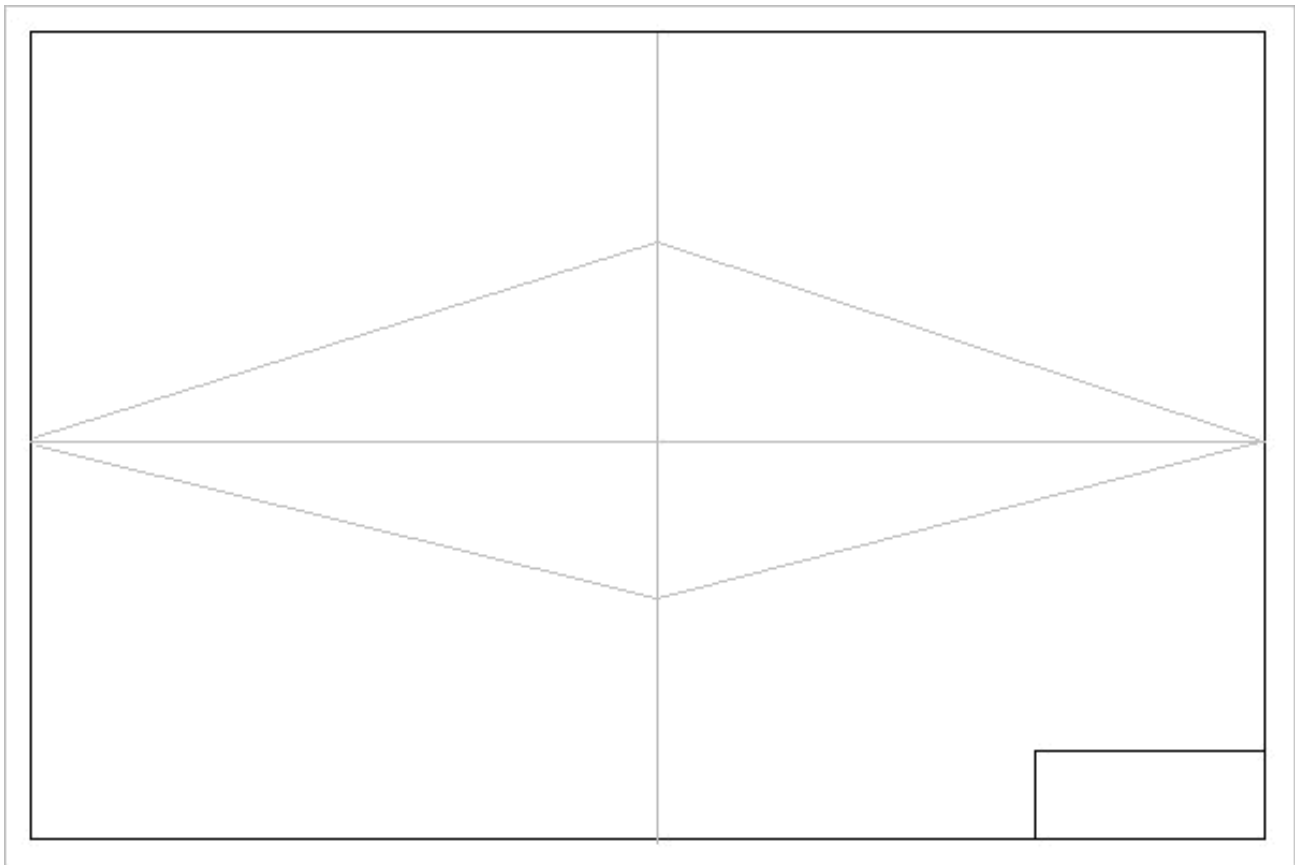

c) Approximate the next four light lines as shown - if the students are unsure then give absolute measurements 50mm (2") down - 75mm(3") up from the center.

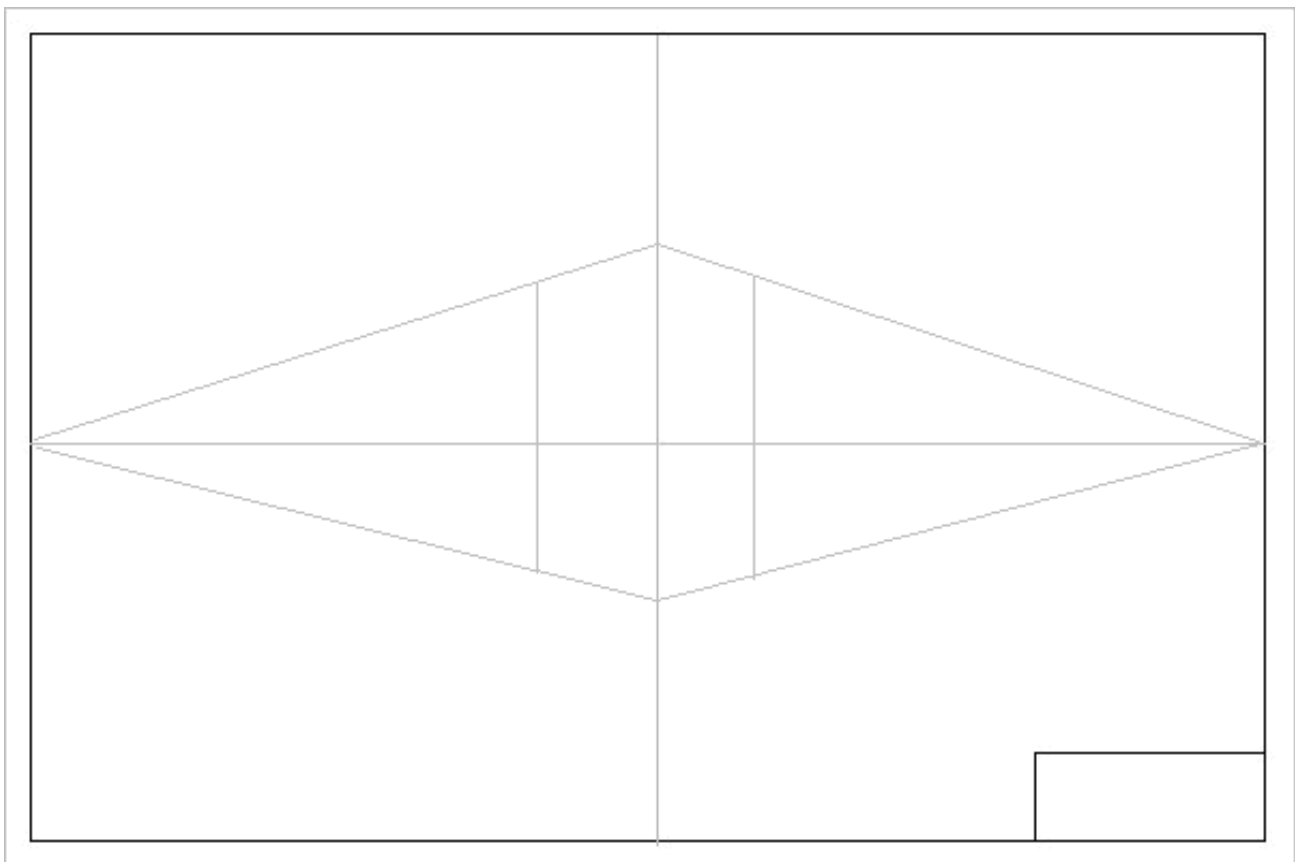

d) Add the verticals as light construction lines. Note to the students that only three types of lines to be made, vertical lines or lines to the right VP or left VP ... there are none other. Again, give measurements if considered necessary. 35mm (1-1/2") right 50mm (2") left of center.

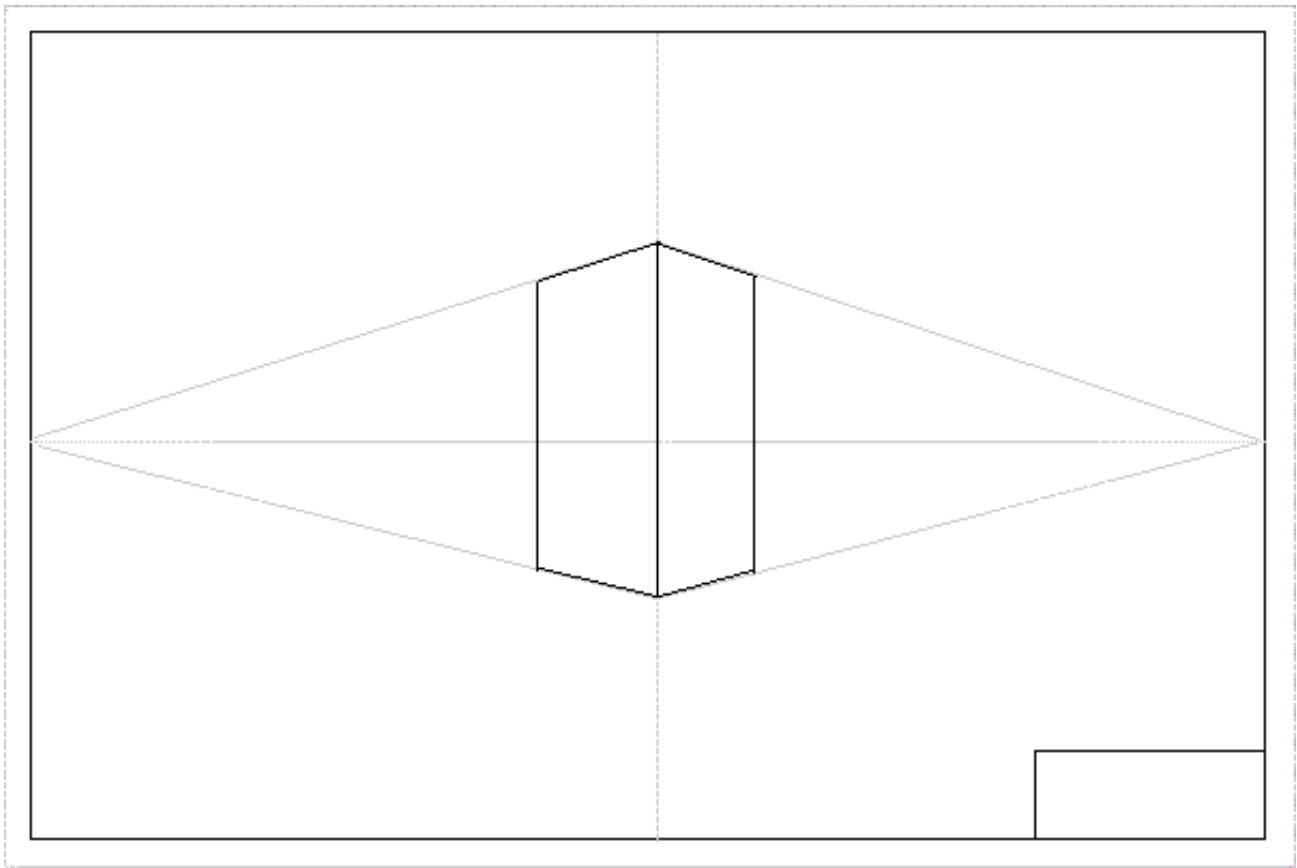

e) Construct the next set of verticals to approximate (below) then join the tops to RVP and LVP.

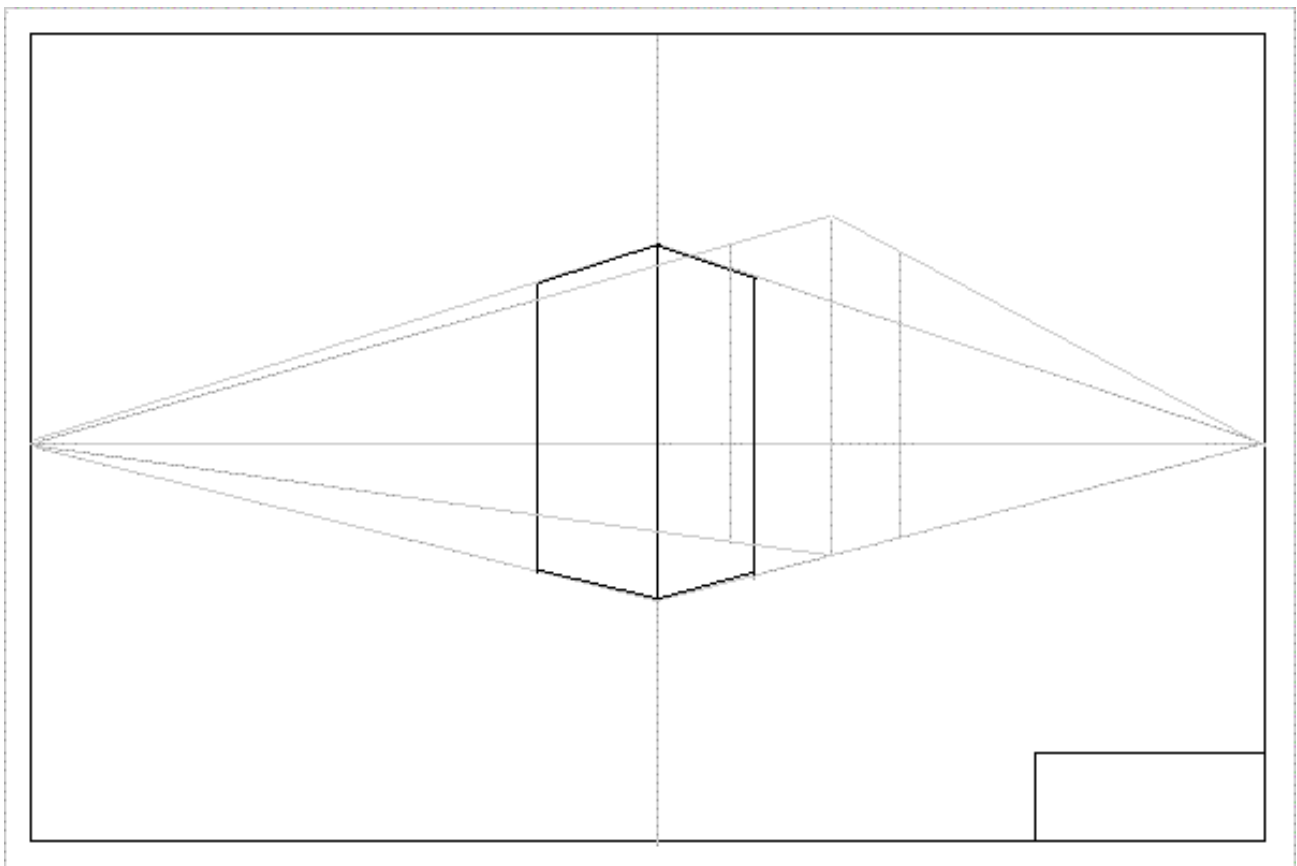

f) Firm in the lines shown.

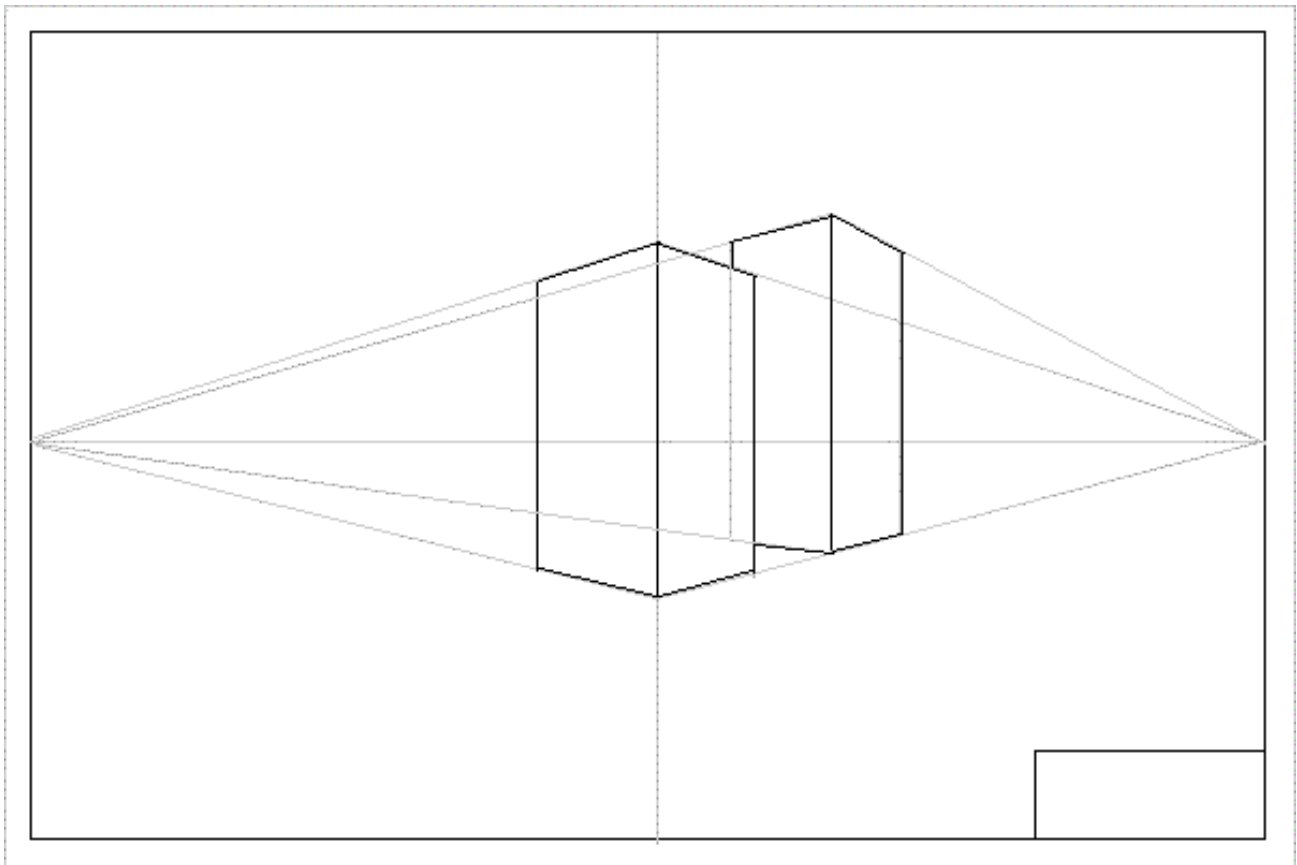

g) Do again on the left of the centre as demonstrated.

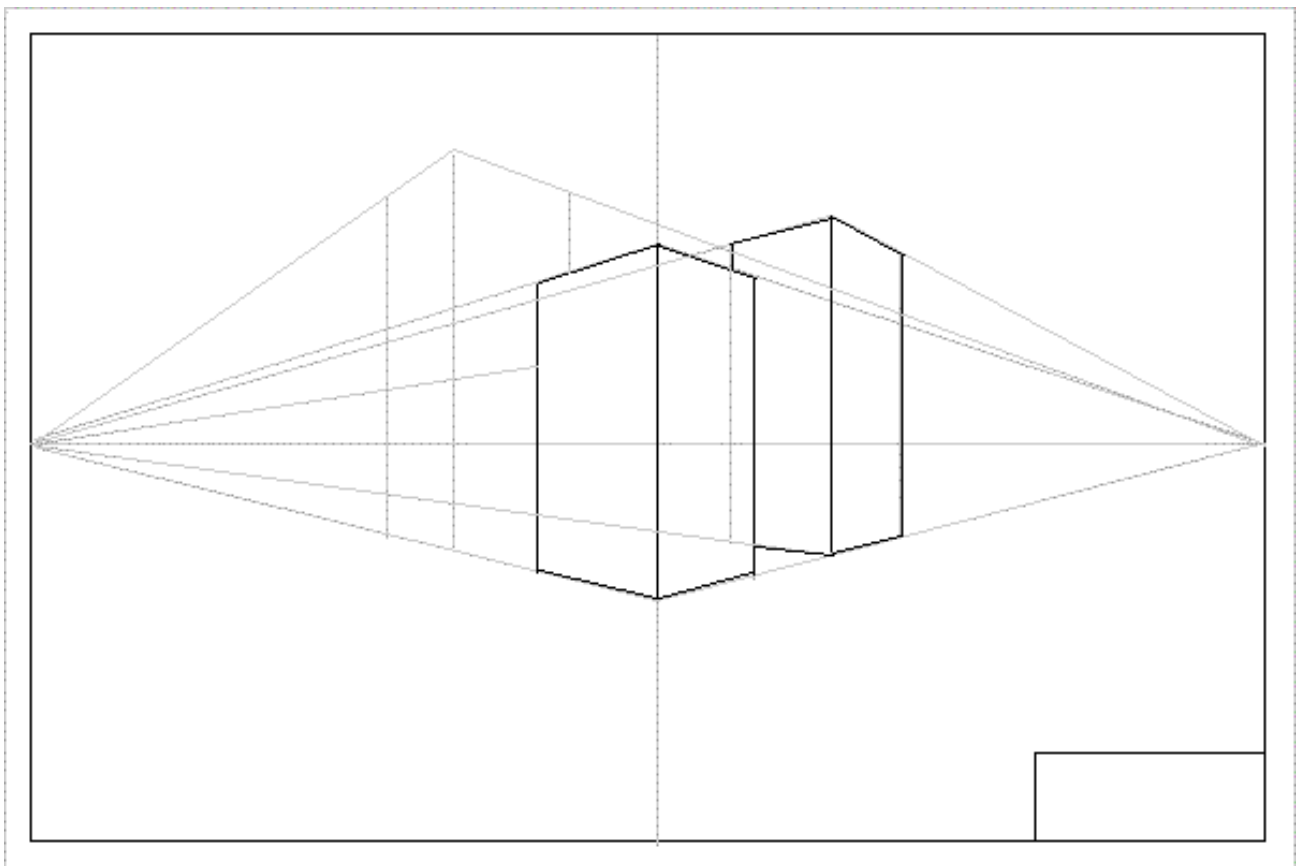

h) Firm in the lines as in my drawing.

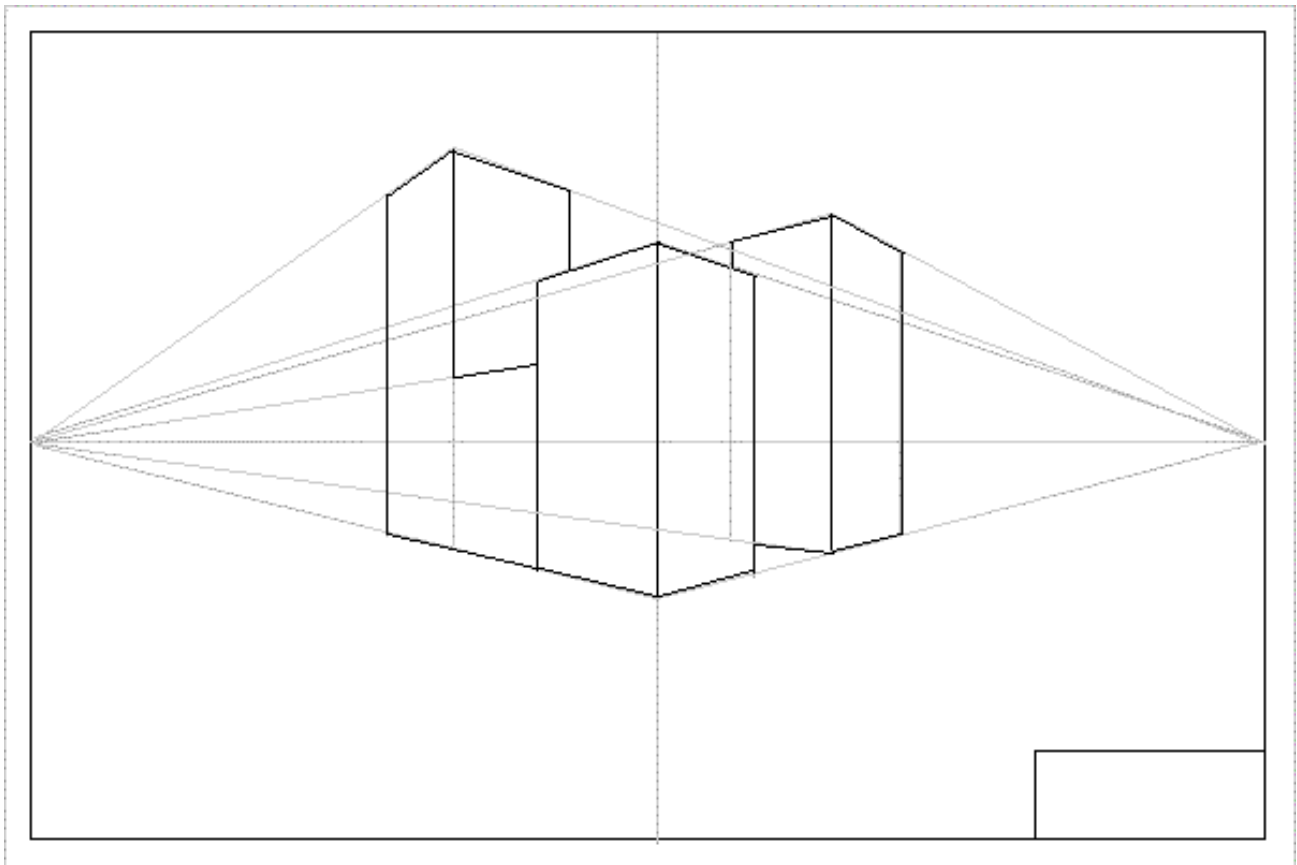

i) Add another lightly.

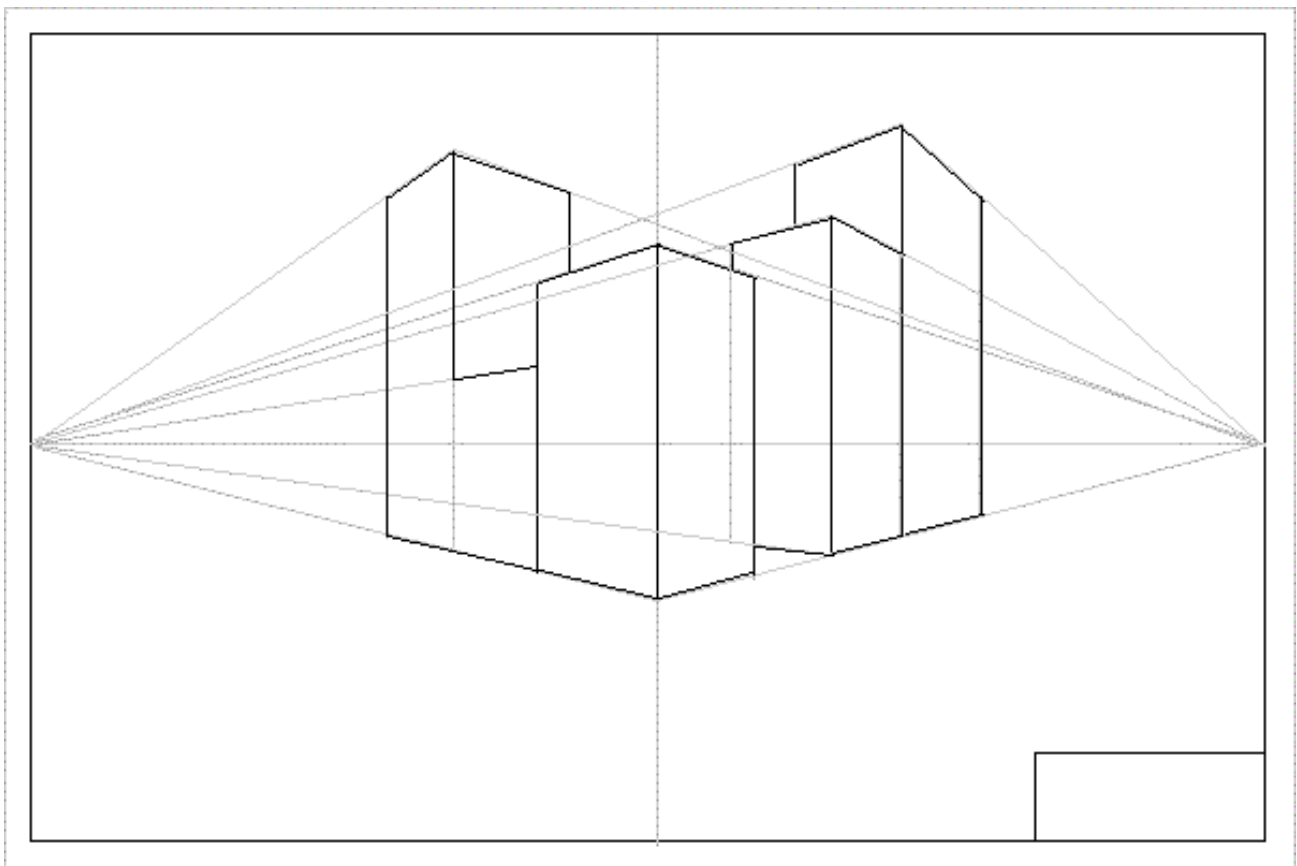

j) Firm in ...

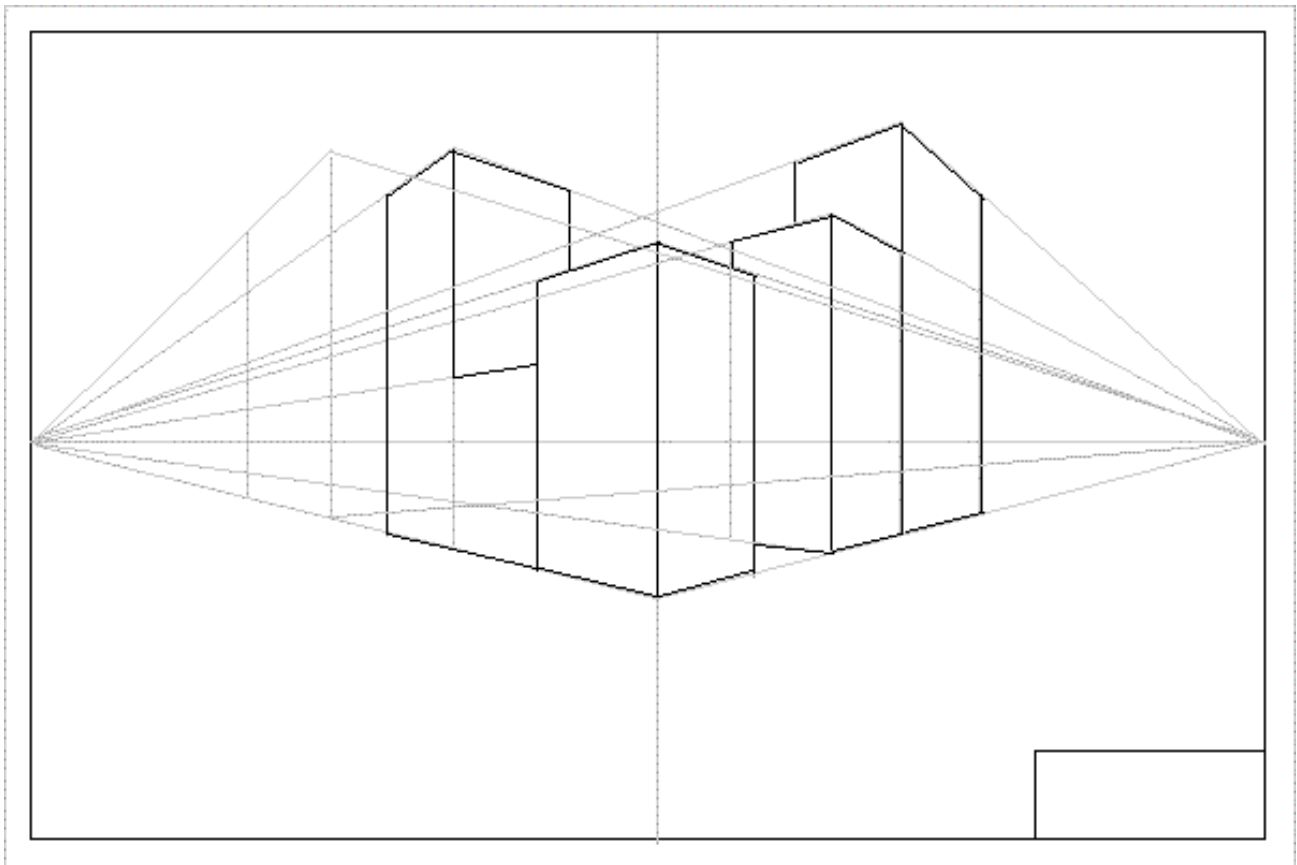

k) and a fifth ...

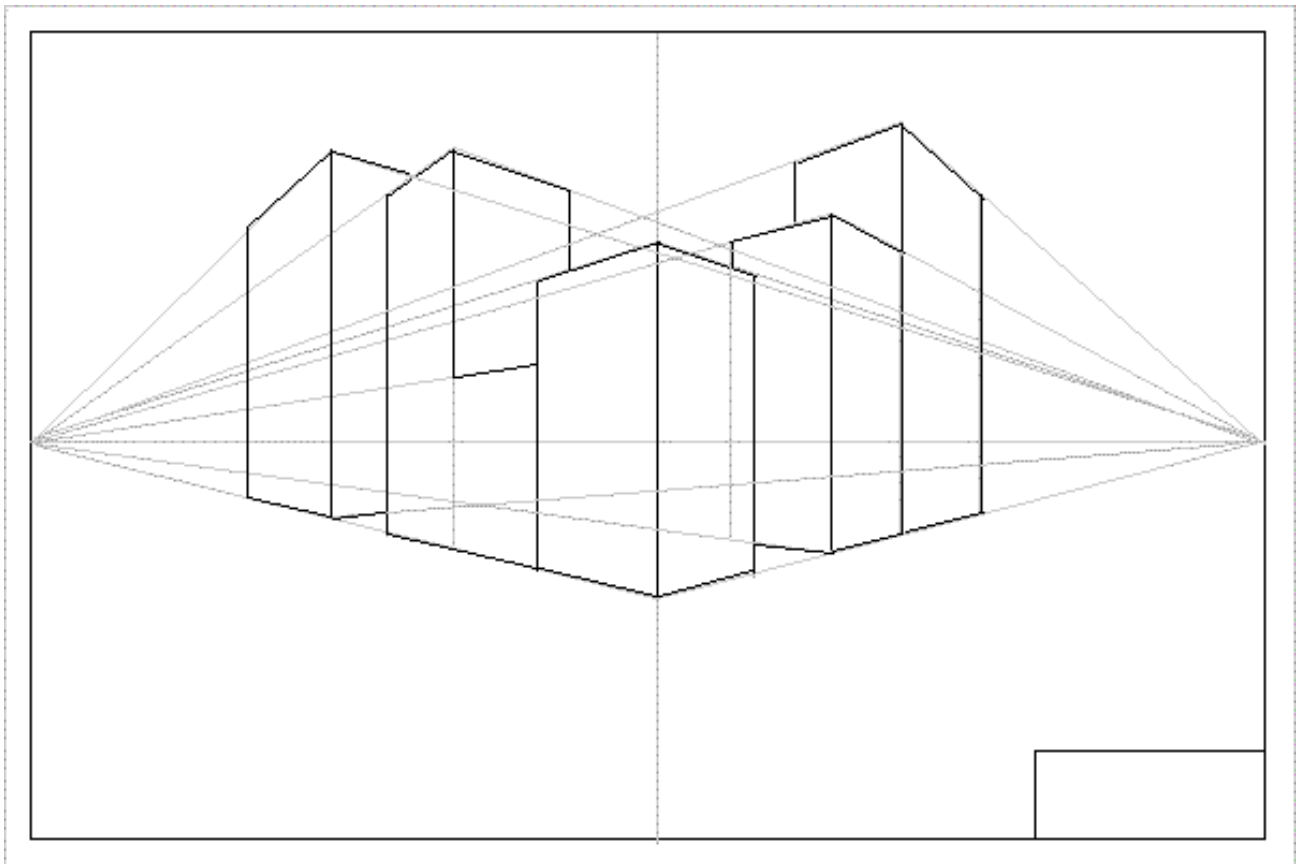

l) Shade the right hand side of the buildings as shown.

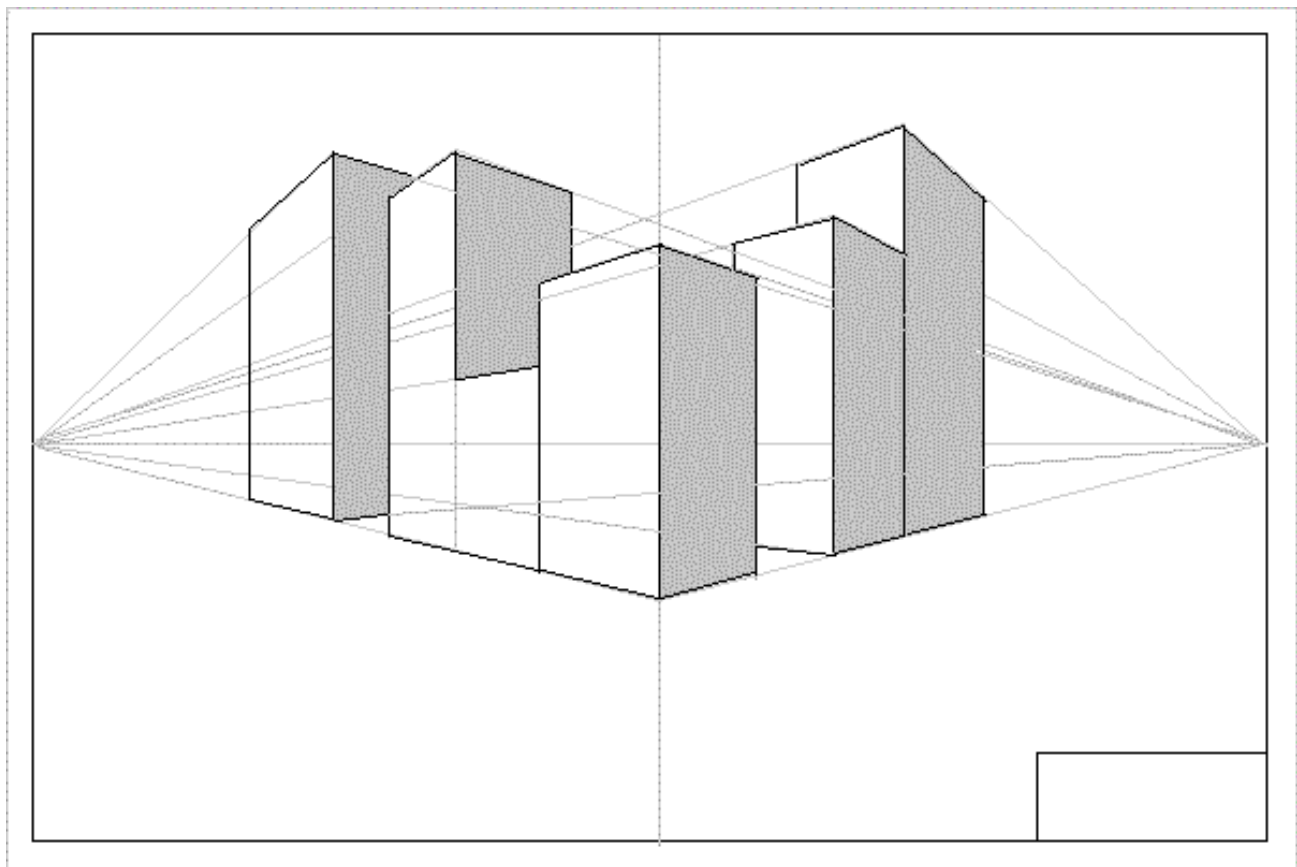

m) Add some light lines as shown to suggest road and pavement - then firm in when satisfied. Demonstrate how to add some suggestions of windows and signs. Have the children hold up their pads at the completion of a particular time. Those who have never drawn in three dimensions will be encouraged and quite keen to continue.

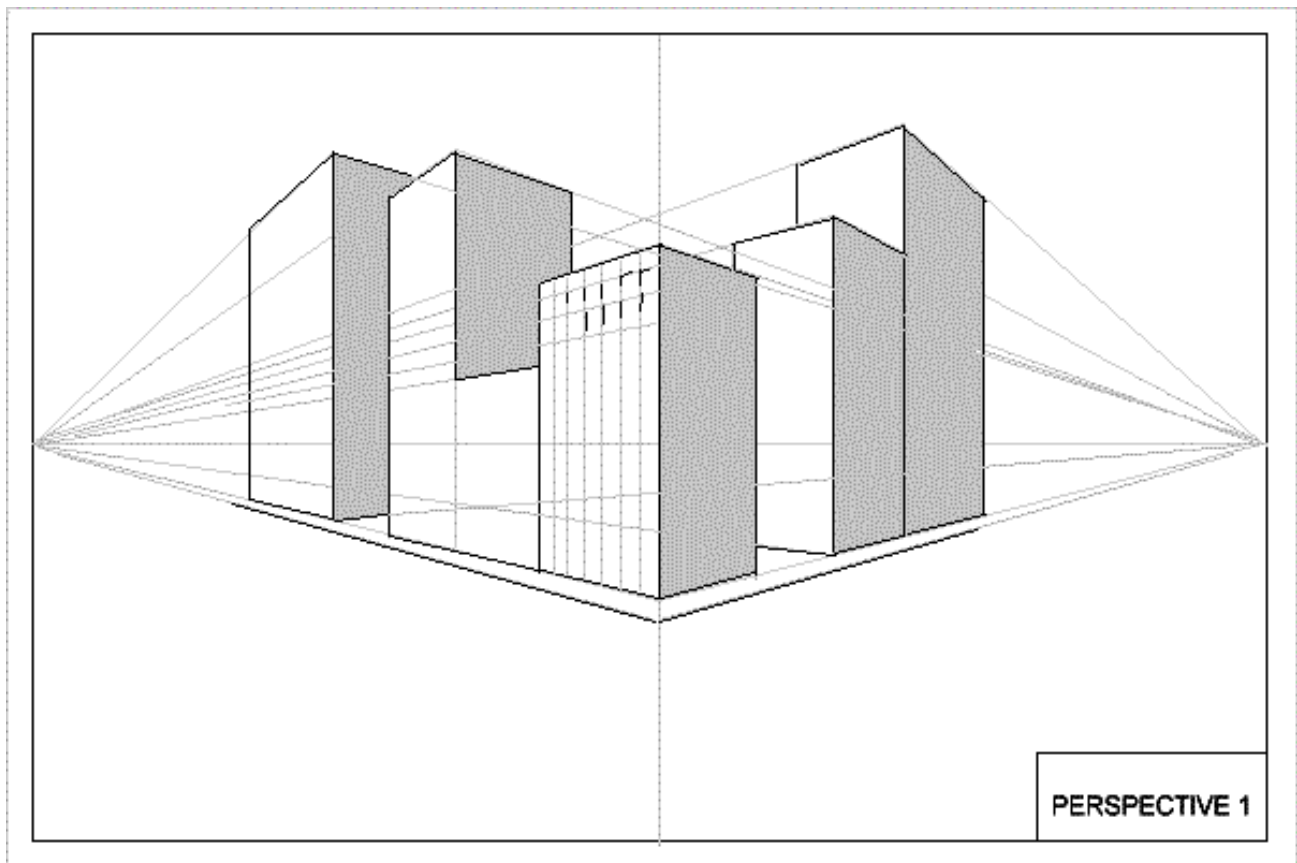

Home work;

Complete the drawing adding more windows, pedestrians, cars, background or more buildings... encourage innovation.

Press [here](#) to go to a master painter's oil painting using two point perspective as shown above.
Press back to return.



[GO TO ... LESSON TWO](#)

[lesson menu](#)



LESSON - PERSPECTIVE TWO - CITY STREET (UP)

TIME:

Allow 40min - teacher preparation: prepare sketch beforehand with measurements.

Aim:

To introduce the student to the notion of creating a three dimensional vista on a two dimensional plane. This lesson follows on and develops the theme of the previous lesson.

Materials:

The sketch pad,
HB pencil, ruler, eraser

Prepare a new page with the margin as in the previous lesson using the ruler and HB pencil ...

a) Quarter the page as shown with light lines. Teacher should do this on the chalkboard then wait for the students to catch up.

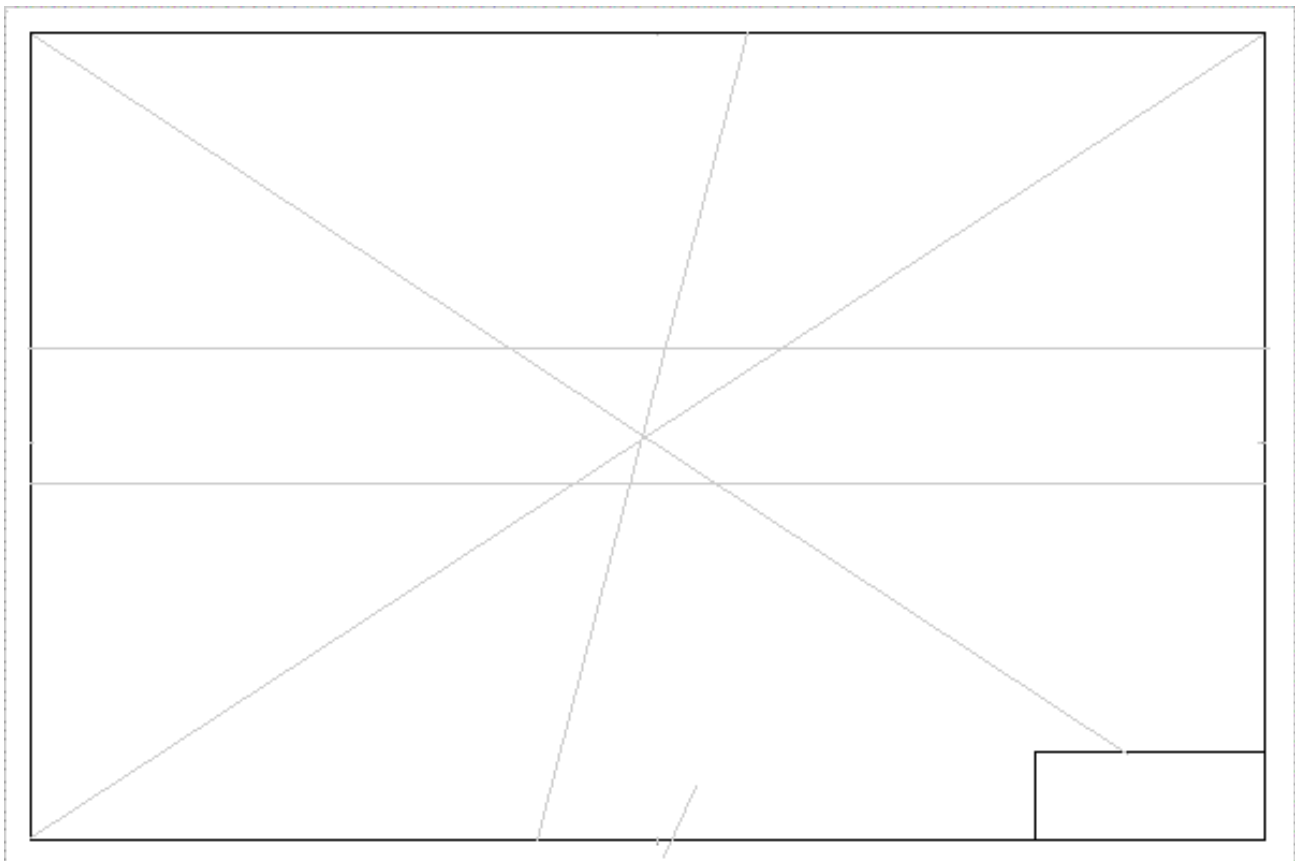

b) In this lesson we are going to use only one vanishing point (CVP) and it is in the center of the page. Place in the lines approximately as shown. Parallel lines are 20mm (3/4") down and 30mm (1,1/4") up from dead center.

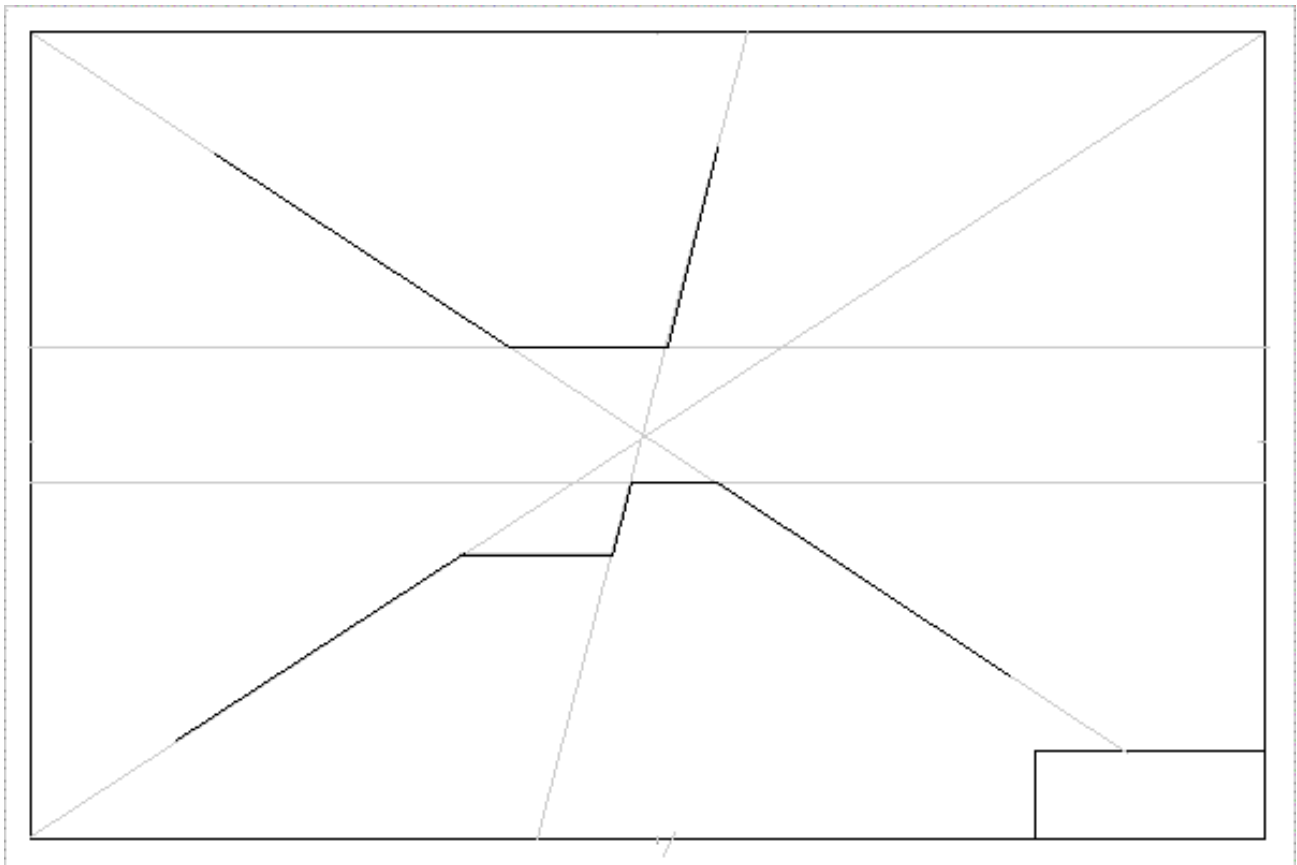

c) Firm in the lines shown.

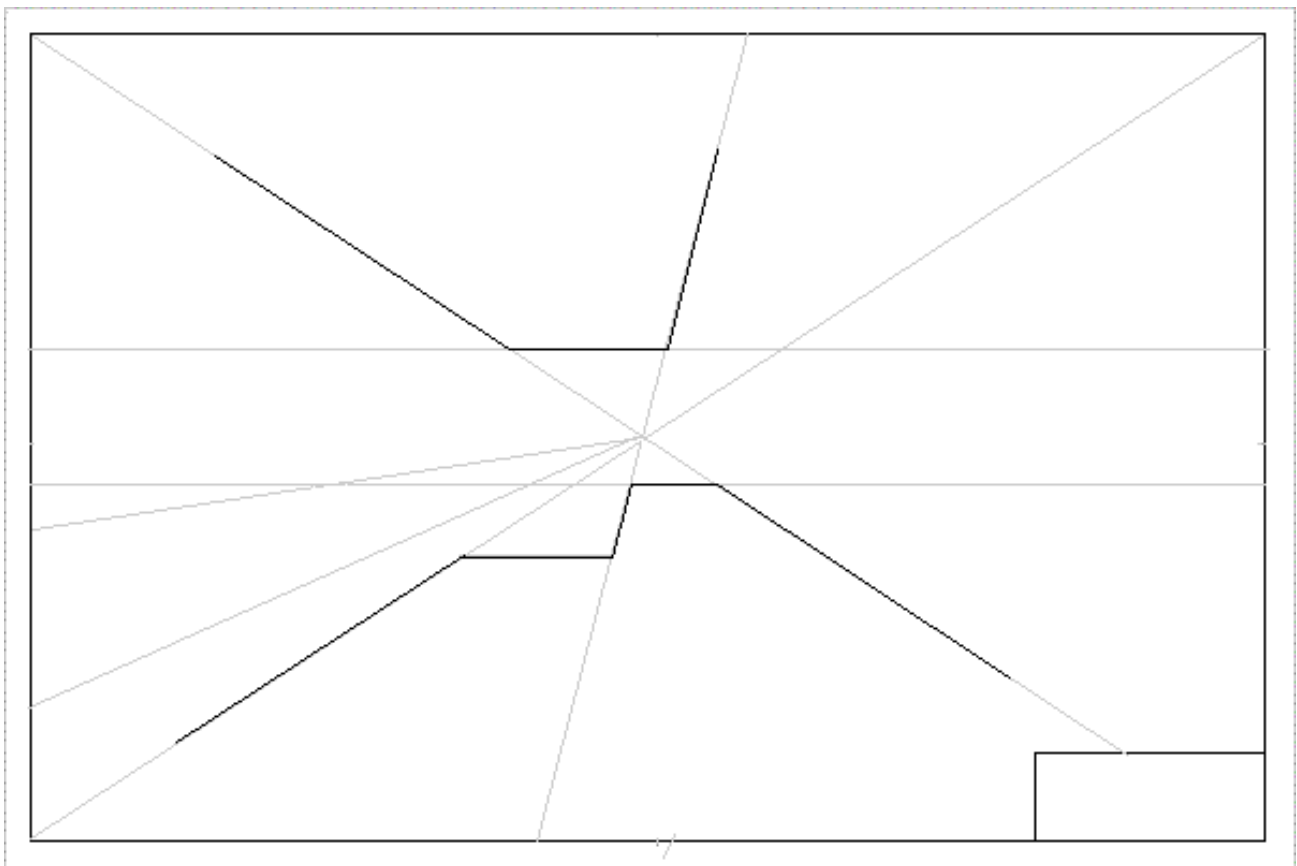

d) Add the next two radiating light lines as demonstrated.

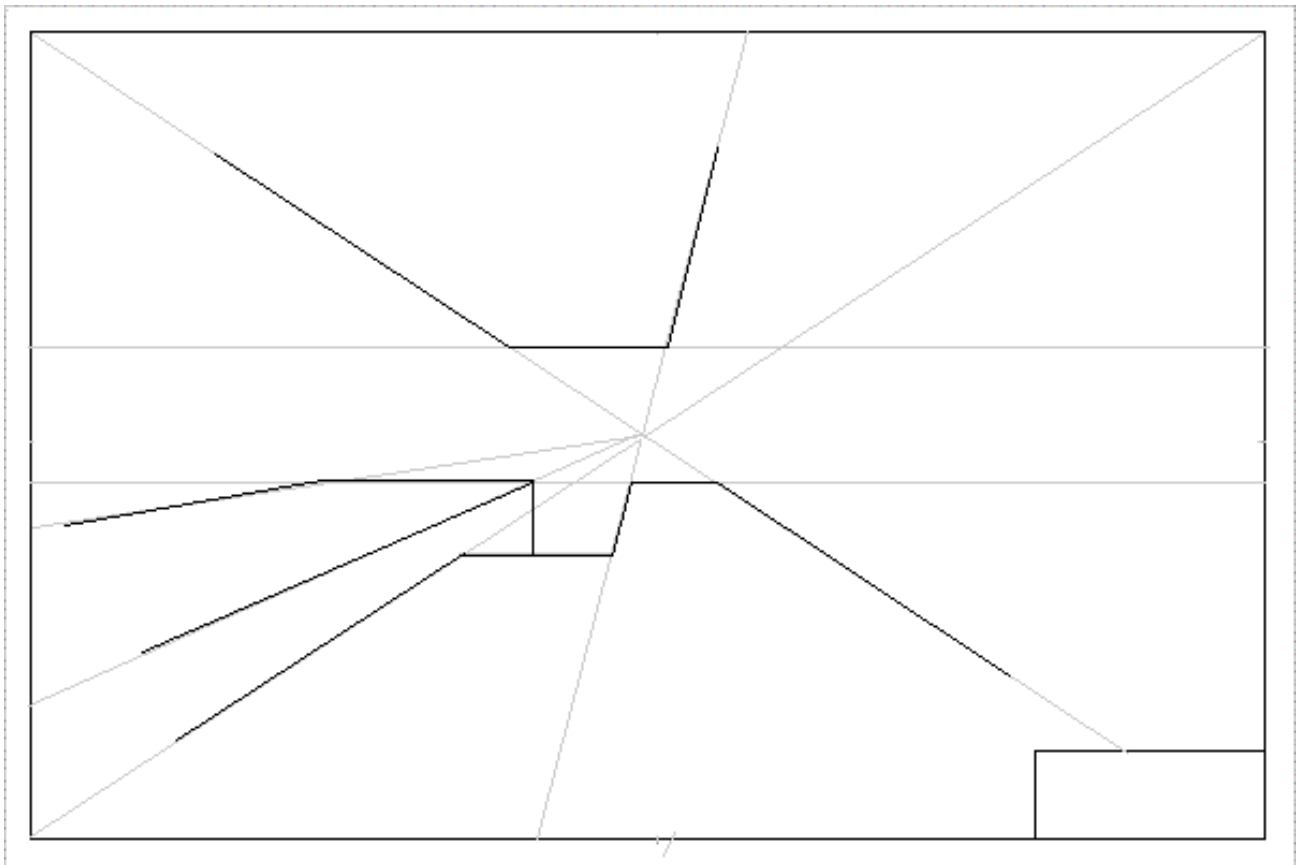

e) Firm in the next skyscraper - note to the student that all lines in this drawing are either horizontal, vertical or radiate out from the center. There are no others!

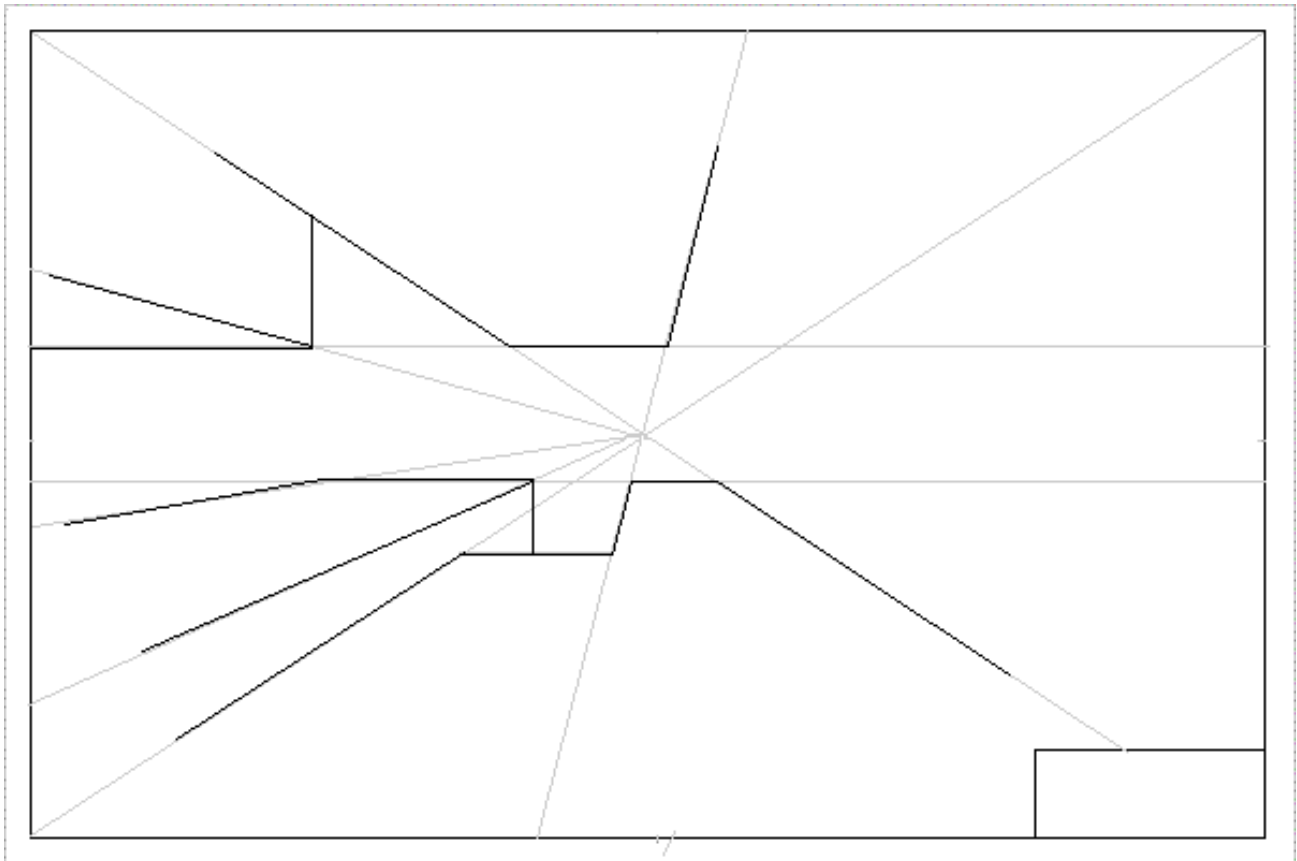

f) Add the next building as shown.

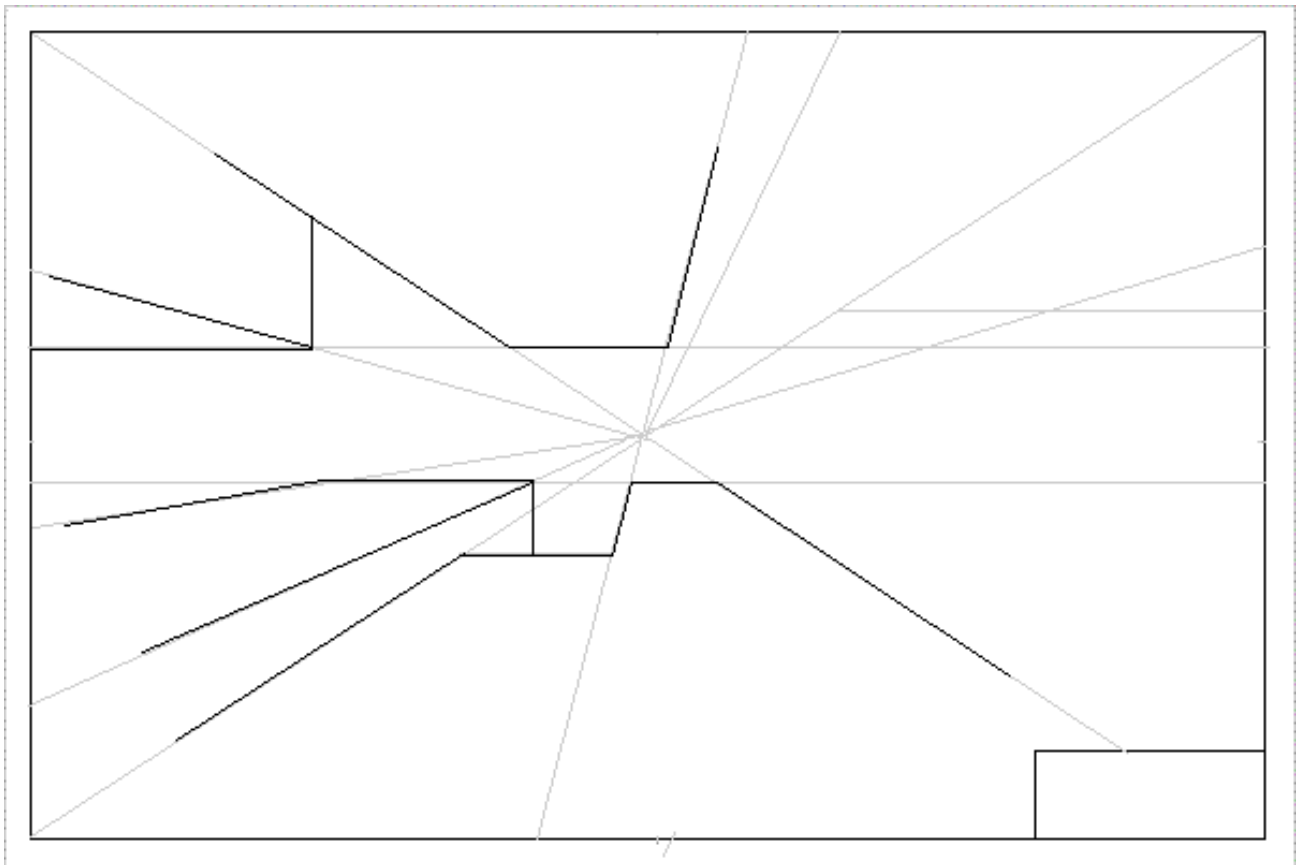

g) Some more light construction lines ...

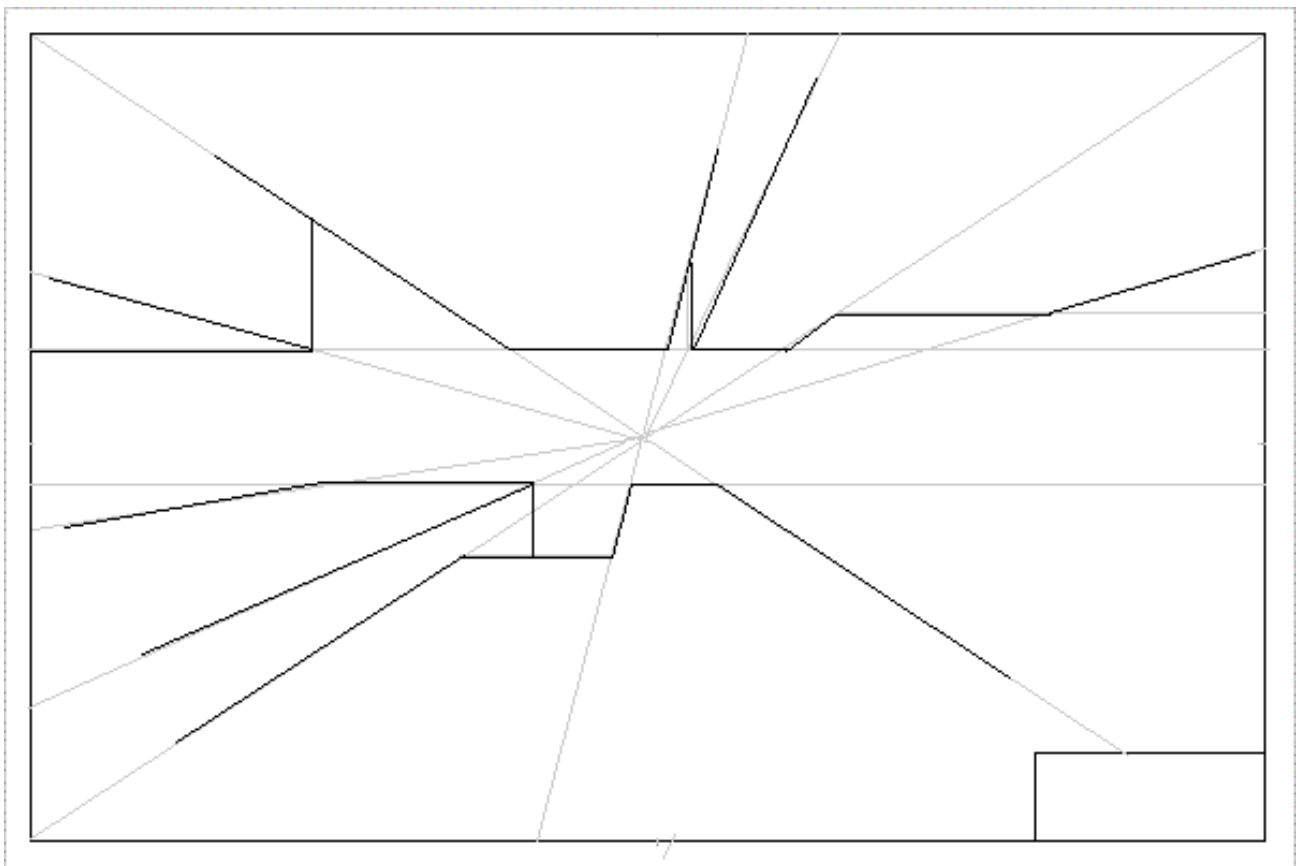

h) ... and firm in the lines as shown.

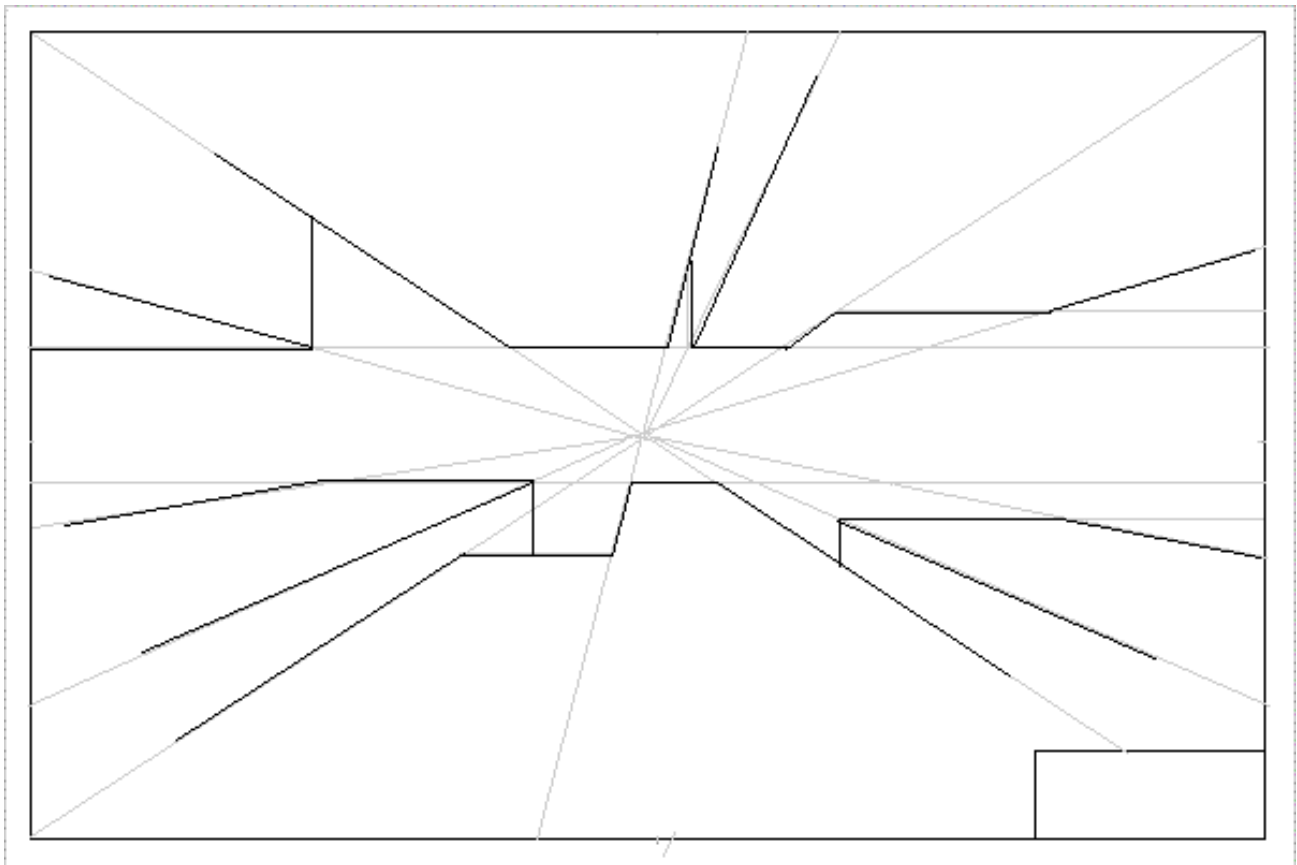

i) The essential 'structure' is complete.

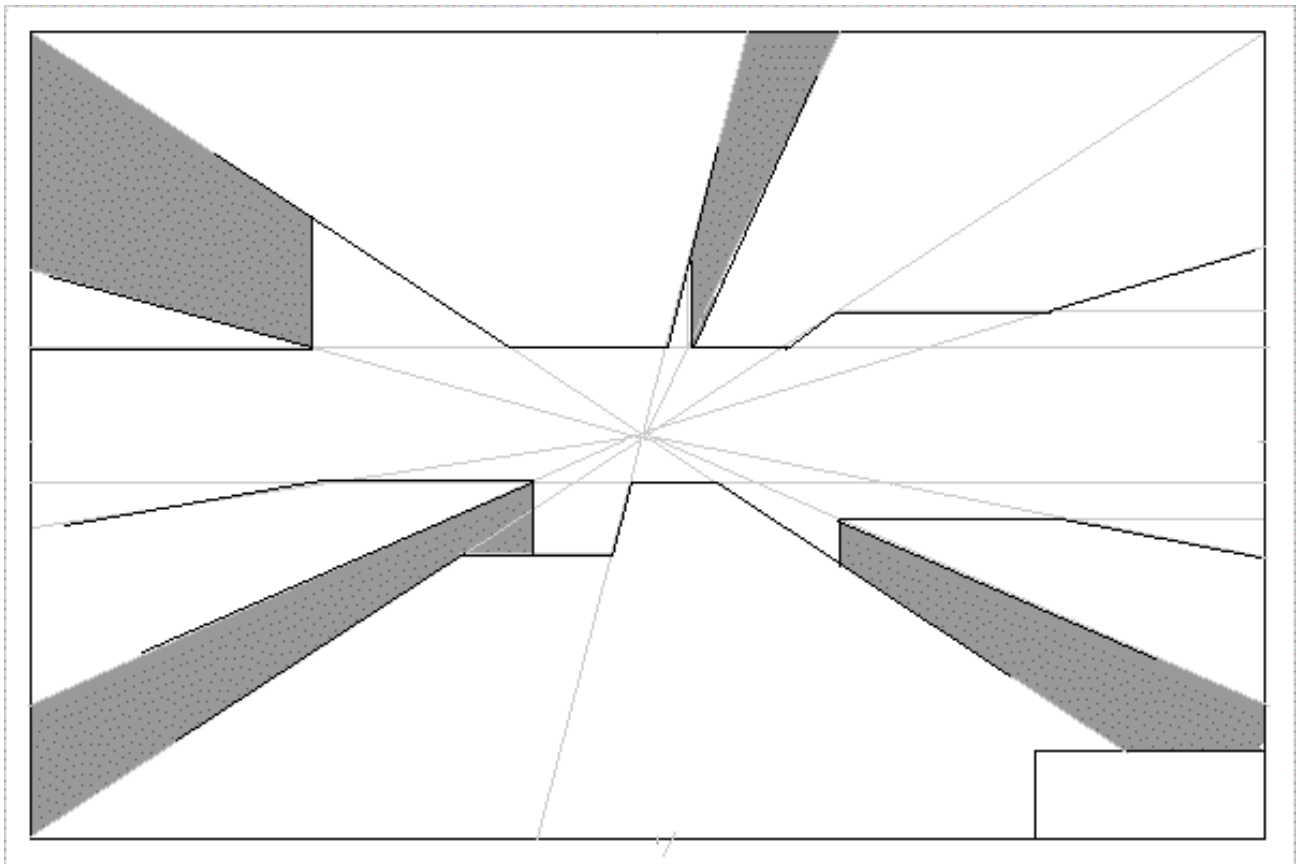

j) Now for a little shading.

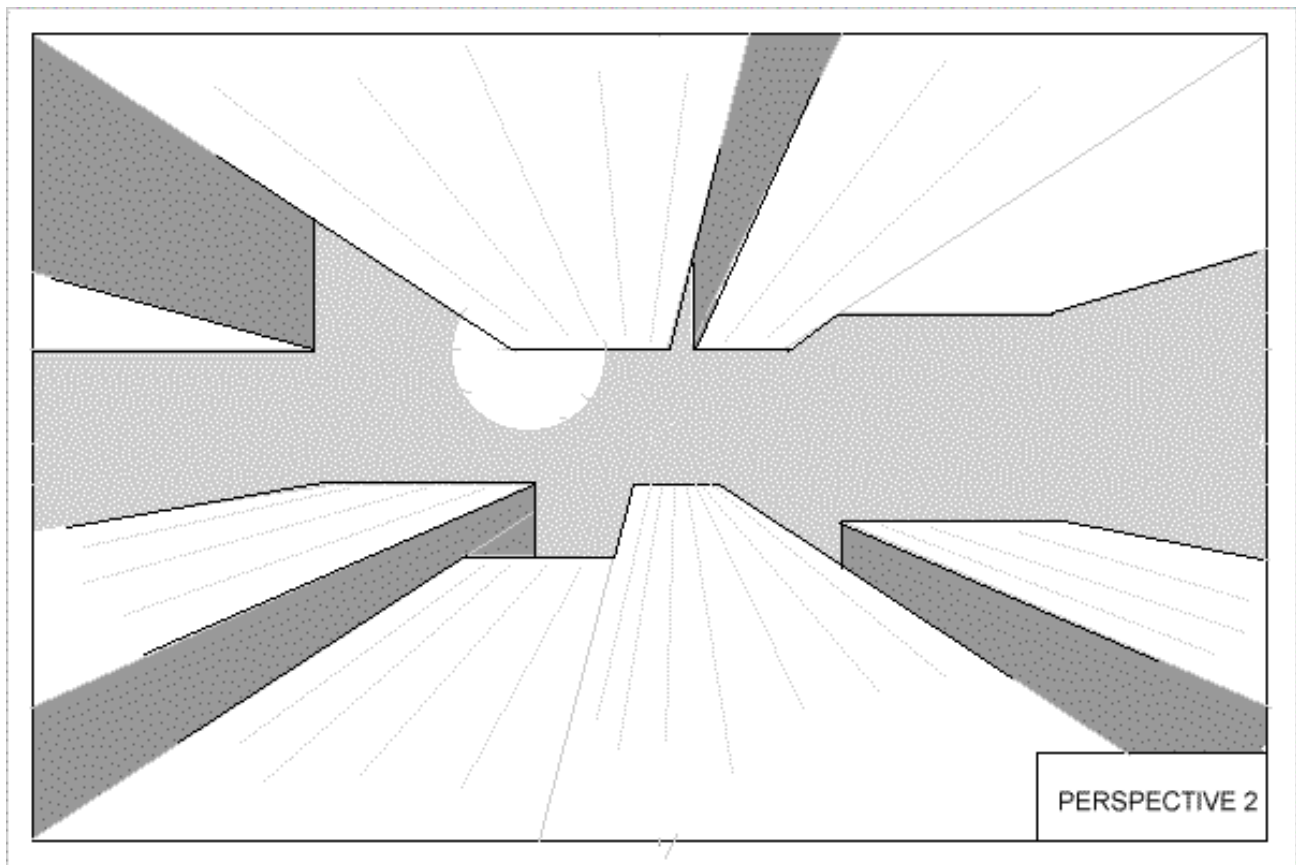

Print in the title, add some light lines as shown to suggest windows, then firm in when satisfied. Further shading and details can be completed at home.

Home work;

Complete the drawing adding clouds, birds, more windows etc ... to your satisfaction.



[GO TO ... LESSON THREE](#)

[lesson menu](#)

For those folk who have enquired a **CD version** of these 'painting' as well as 'drawing lessons' and 'advanced painting' lessons will soon, I hope, be available to everyone. It will be an updated, reformatted for easy printing version so you can create you own reference handbook in your own time, or just browse the CD.

It is anticipated the CD will be available at around \$15 (plus posting) for students and \$19 (plus posting) for others. The CD's will be distributed on a first come first served basis. Isn't that always the way?

To be added to the list just send me a simple [email](#) with the words 'please notify CD' and your name and status (only if a student or teacher).



LESSON - PERSPECTIVE THREE - CITY STREET (DOWN)

TIME: Allow 40min - teacher preparation minimal.

Aim: This lesson follows on and develops the theme of the previous lesson and intends to introduce the notion that views may differ but structural elements of perspective (and drawing) remain very similar.

Materials: The sketch pad,
HB pencil, ruler.

Prepare as in the previous lesson using the ruler and HB pencil

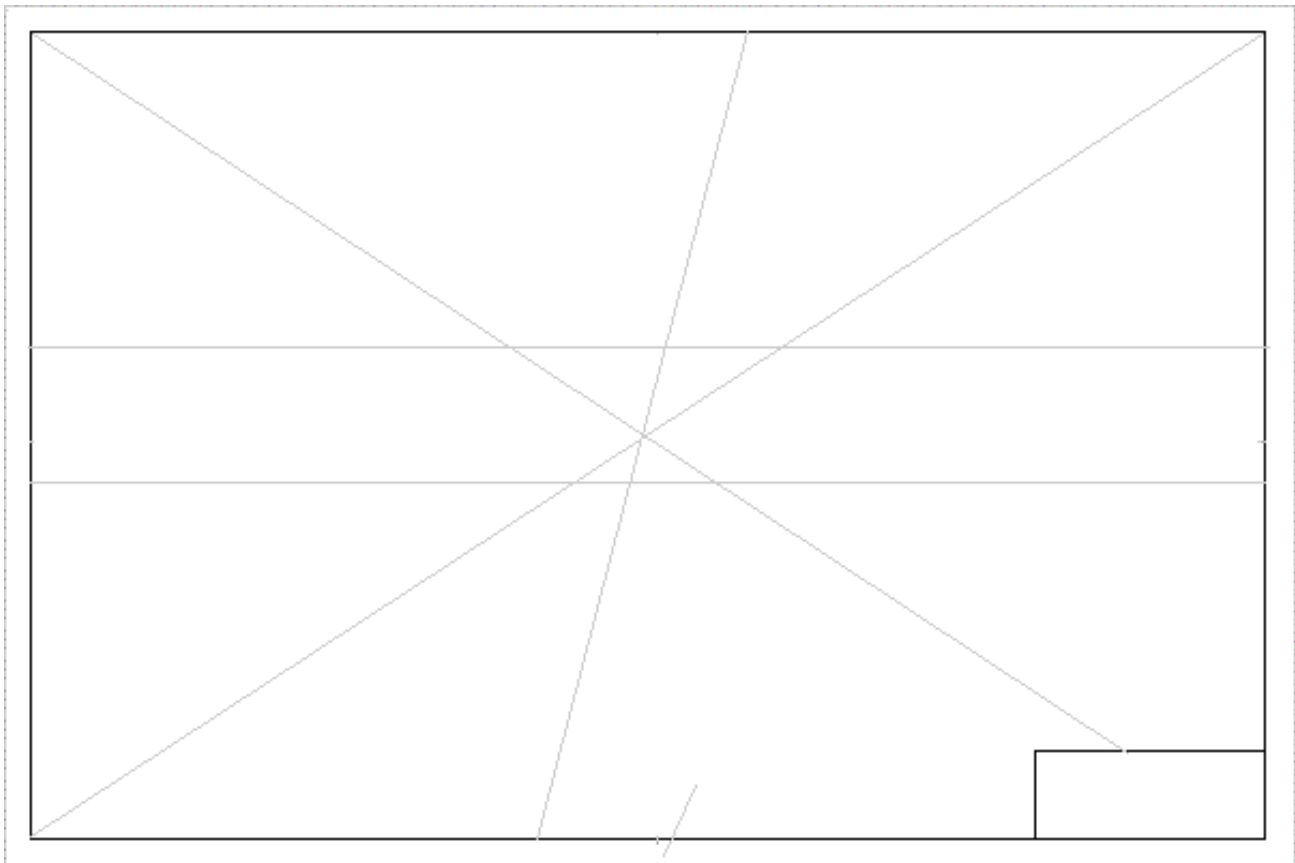

a) Quarter the page as shown with diagonal light lines. Teacher should do this on the chalkboard, then wait for the students to catch up. Add the extra light lines. In this lesson we are again going to use only one vanishing point (CVP) and it is in the center of the page. Place in the lines approximately as shown.

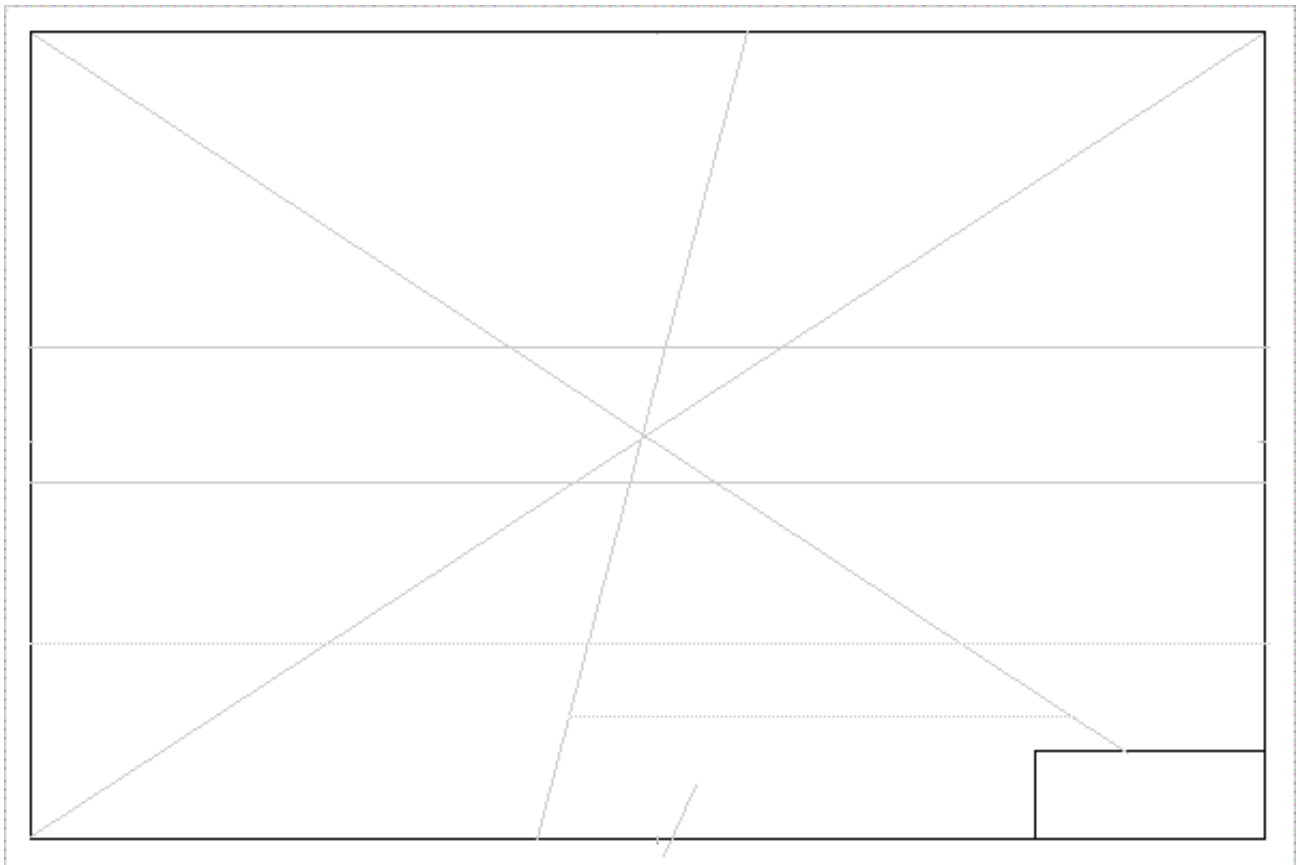

b) Add the two extra light lines.

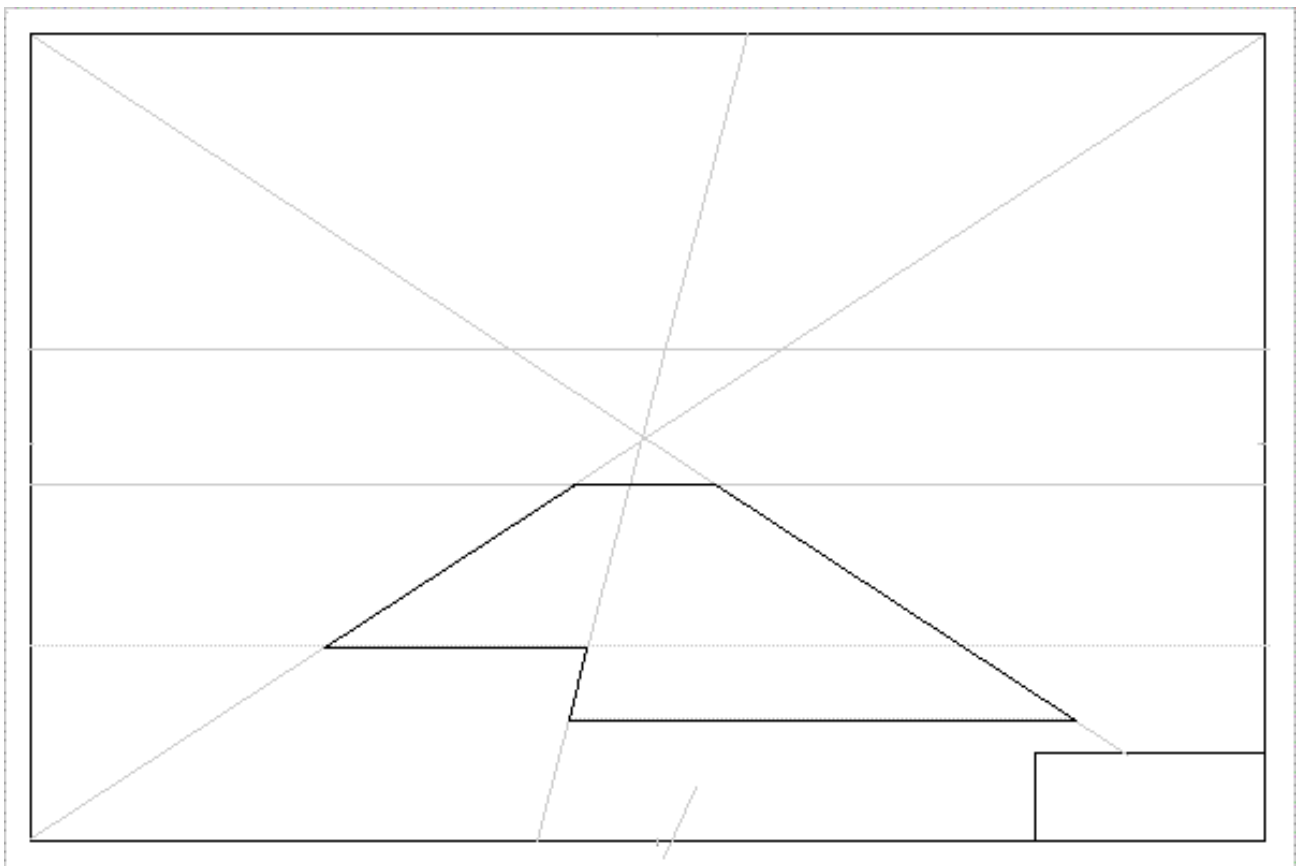

c) Firm in the lines shown.

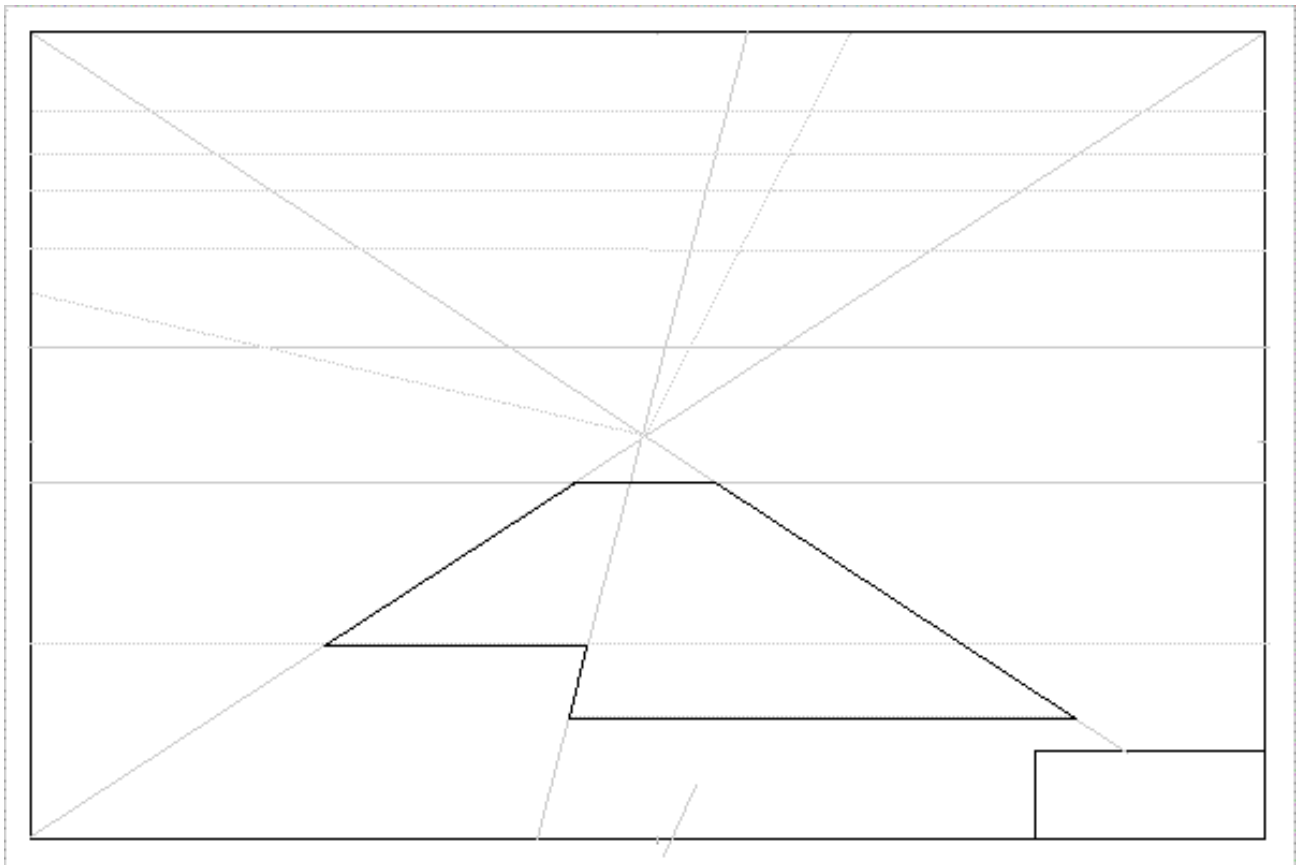

d) Add the next series of horizontal light lines and the two extra radiating lines. Give measurements of students are unsure about the position of the horizontal lines as some students become nervous about mistakes - again note to the student that all lines in this drawing are either horizontal, vertical or radiate out from the center.

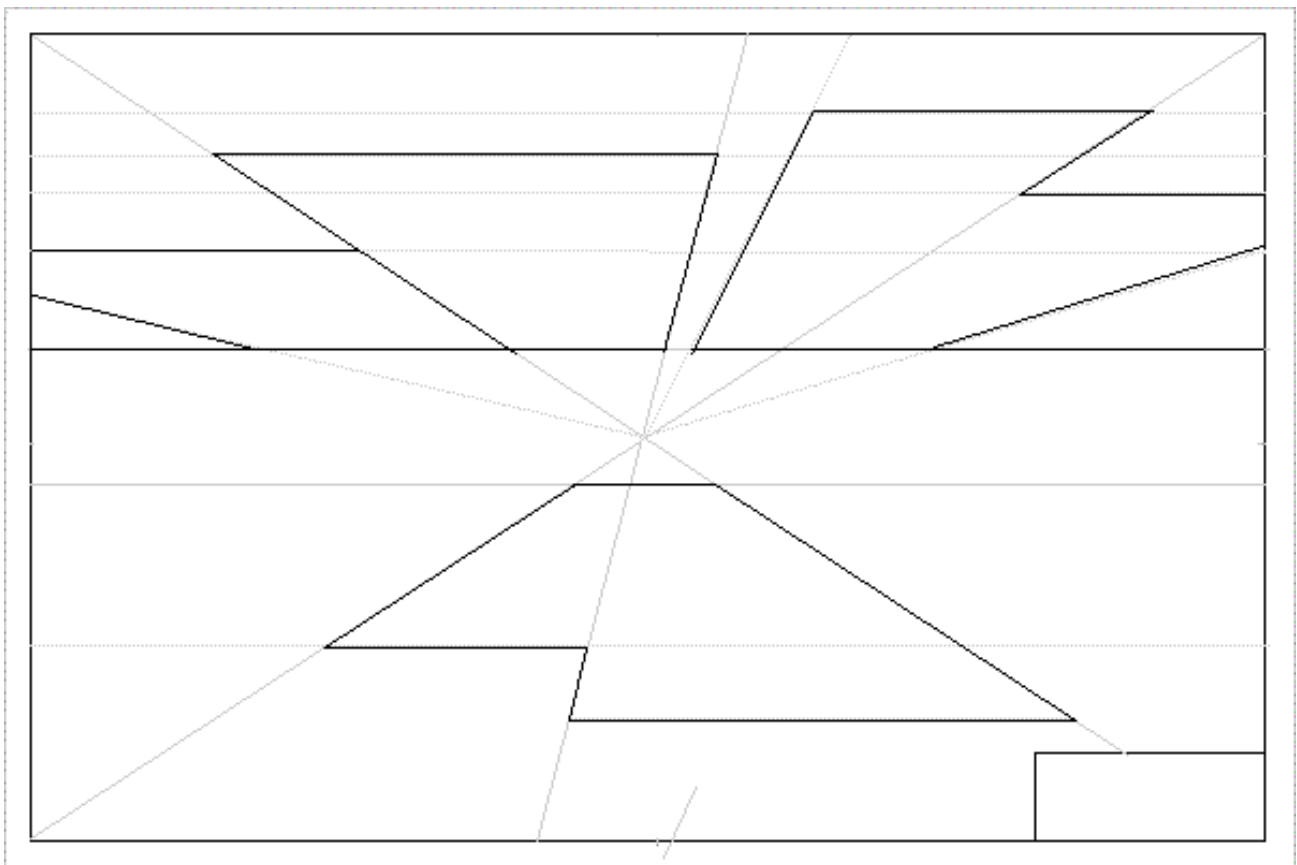

e) Firm in as shown.

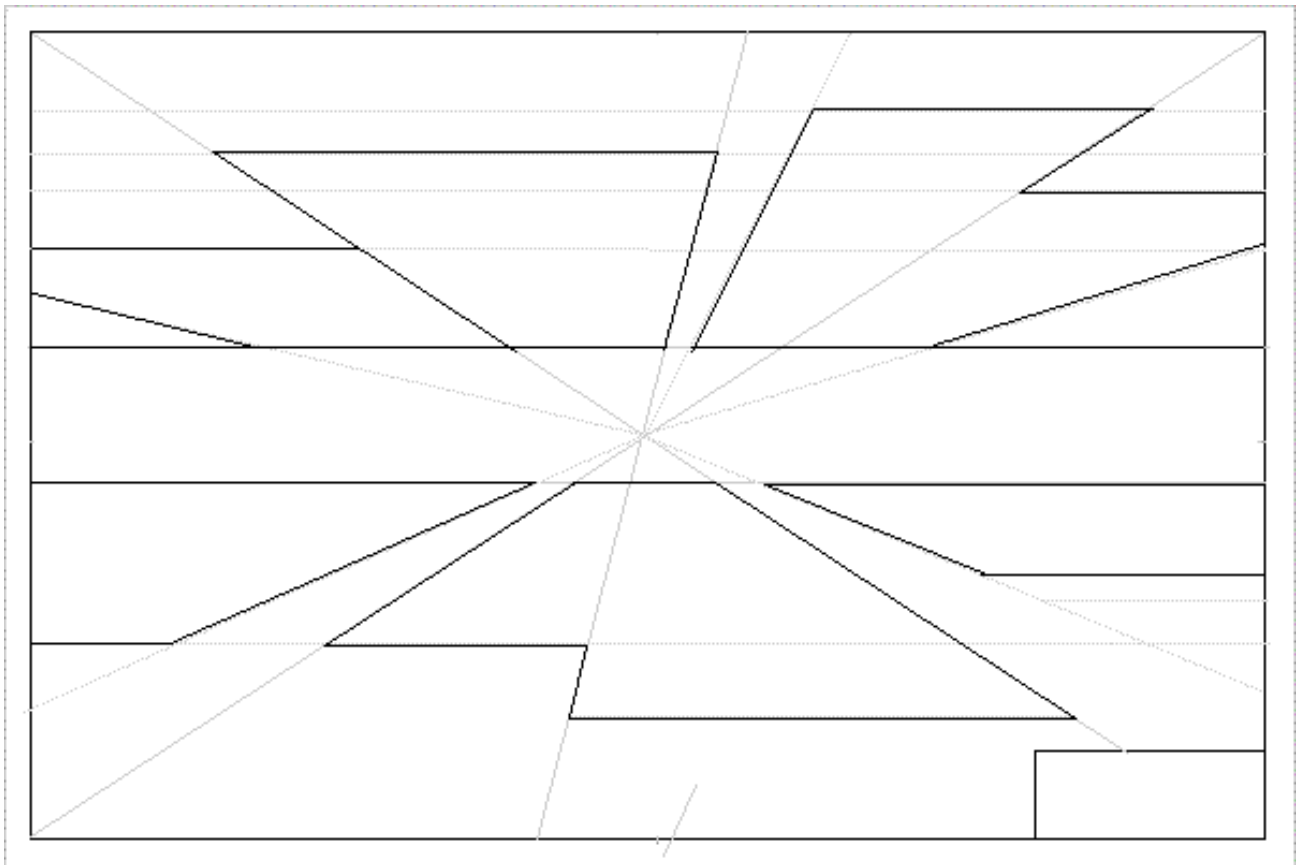

f) Add the extra.

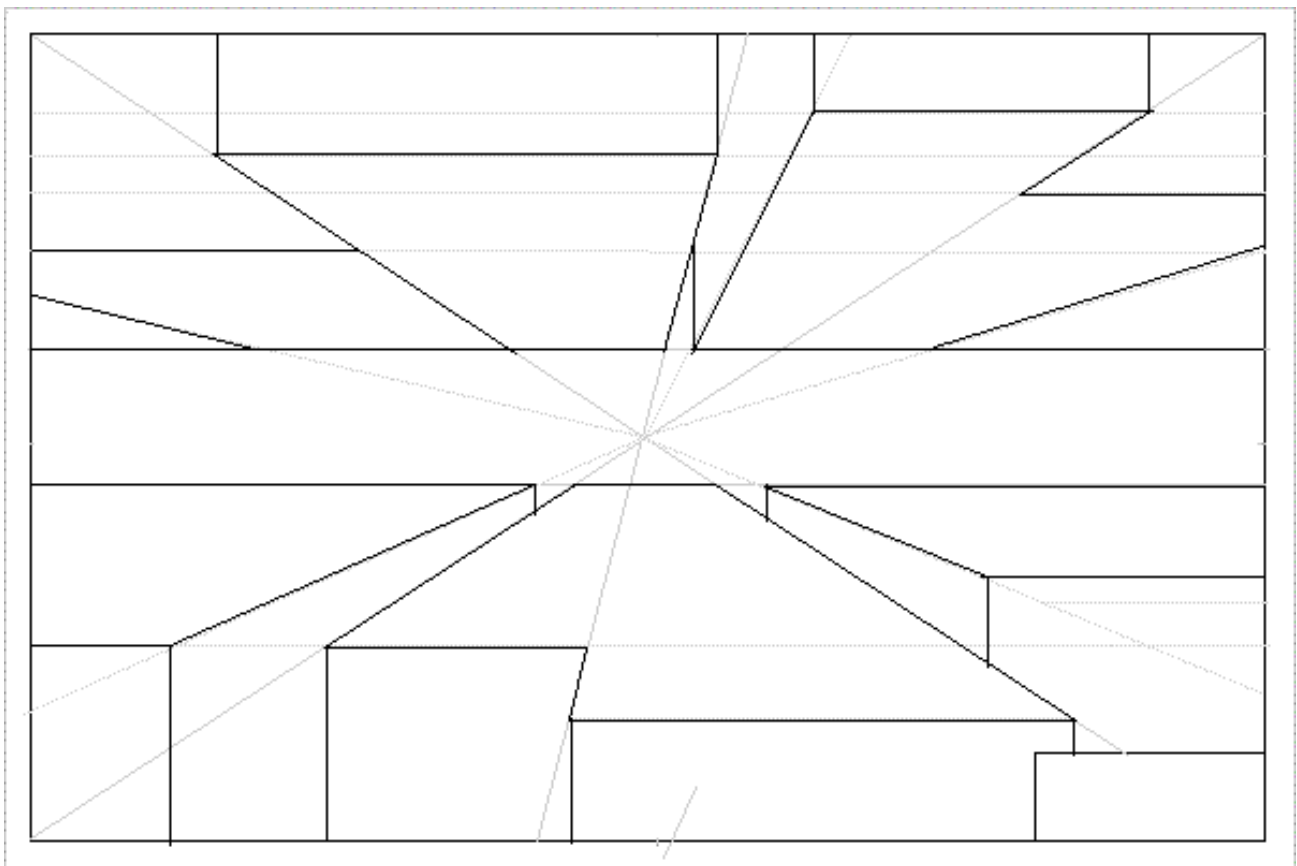

h) Now the vertical lines and the structure begins to take shape.

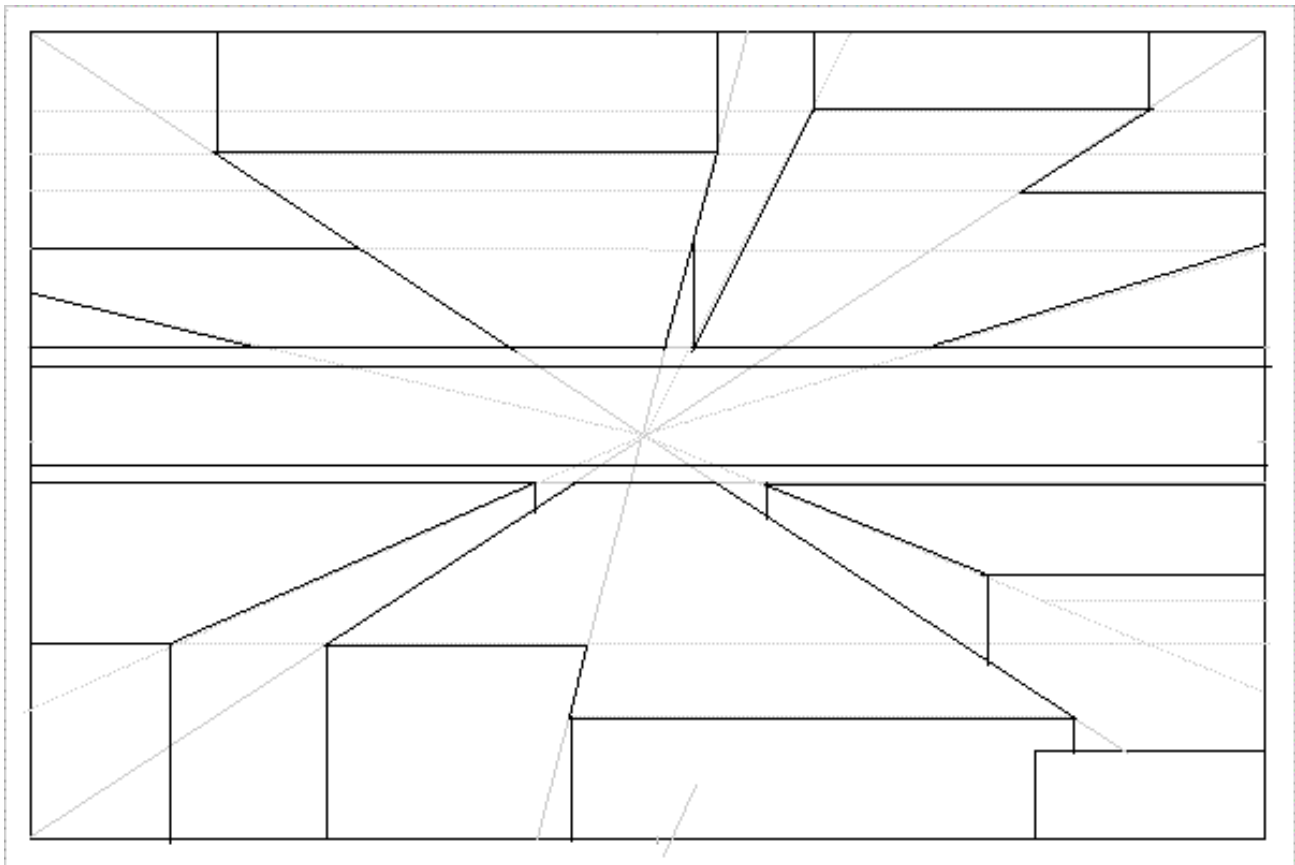

i) The essential 'structure' is done - now two horizontal lines show the pavement edges.

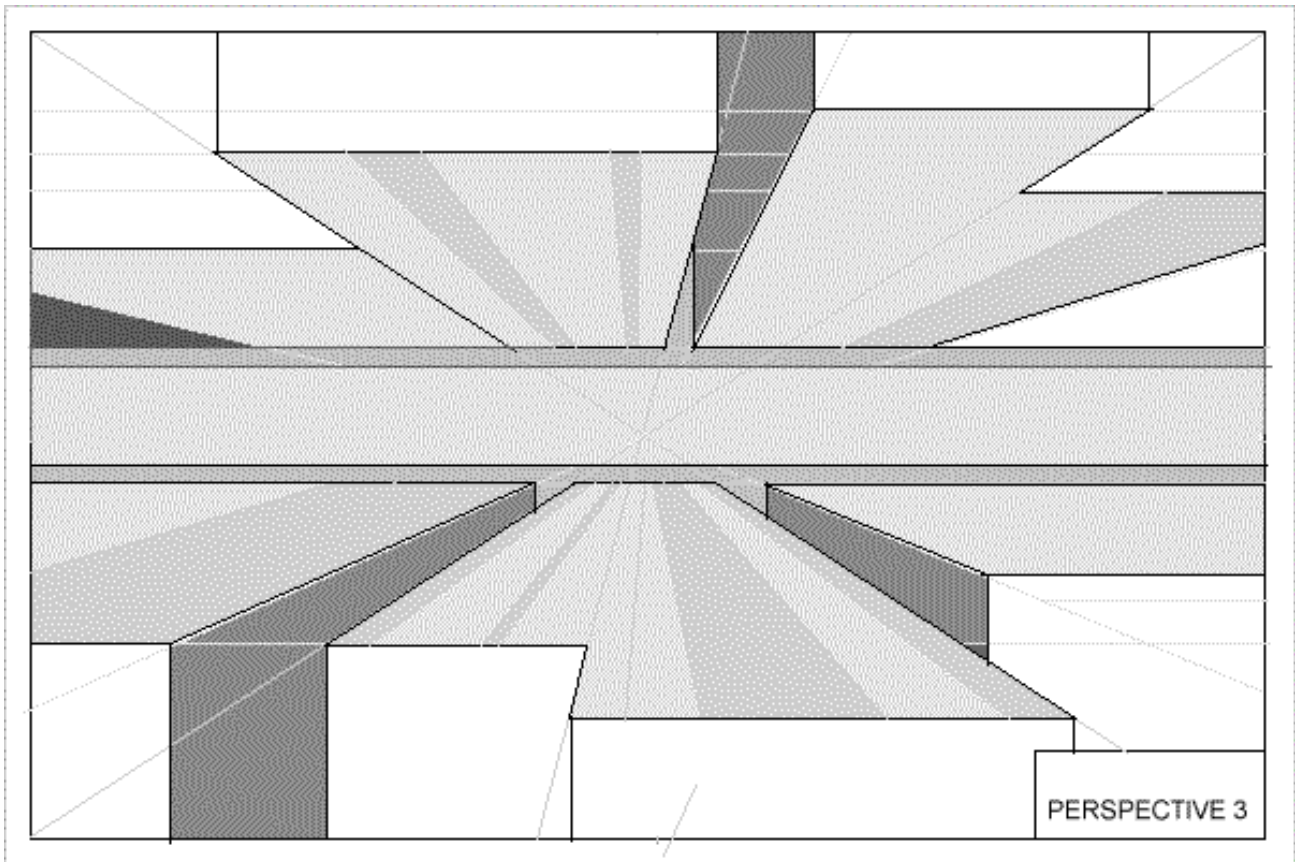

j) Now for a little shading.

Print in the title add some light lines as shown to suggest windows - then firm in when satisfied. Further shading and details can be completed at home.

Homework: Complete the drawing adding cars, pedestrians, heli-pads, more windows etc ...



[GO TO ... LESSON FOUR](#)

[lesson menu](#)



LESSON - PERSPECTIVE FOUR - CORNER OF ROOM

TIME:

Allow 40min

Aim:

To create a perspective grid using a single measurement and three vanishing points. This lesson is to introduce the notion of perspective 'scale'. That is, as things of equal size recede they appear smaller. Perspective is a method of logically determining just how much smaller.

Materials:

The sketch pad,
HB pencil, ruler.

Construct margin and title box then:

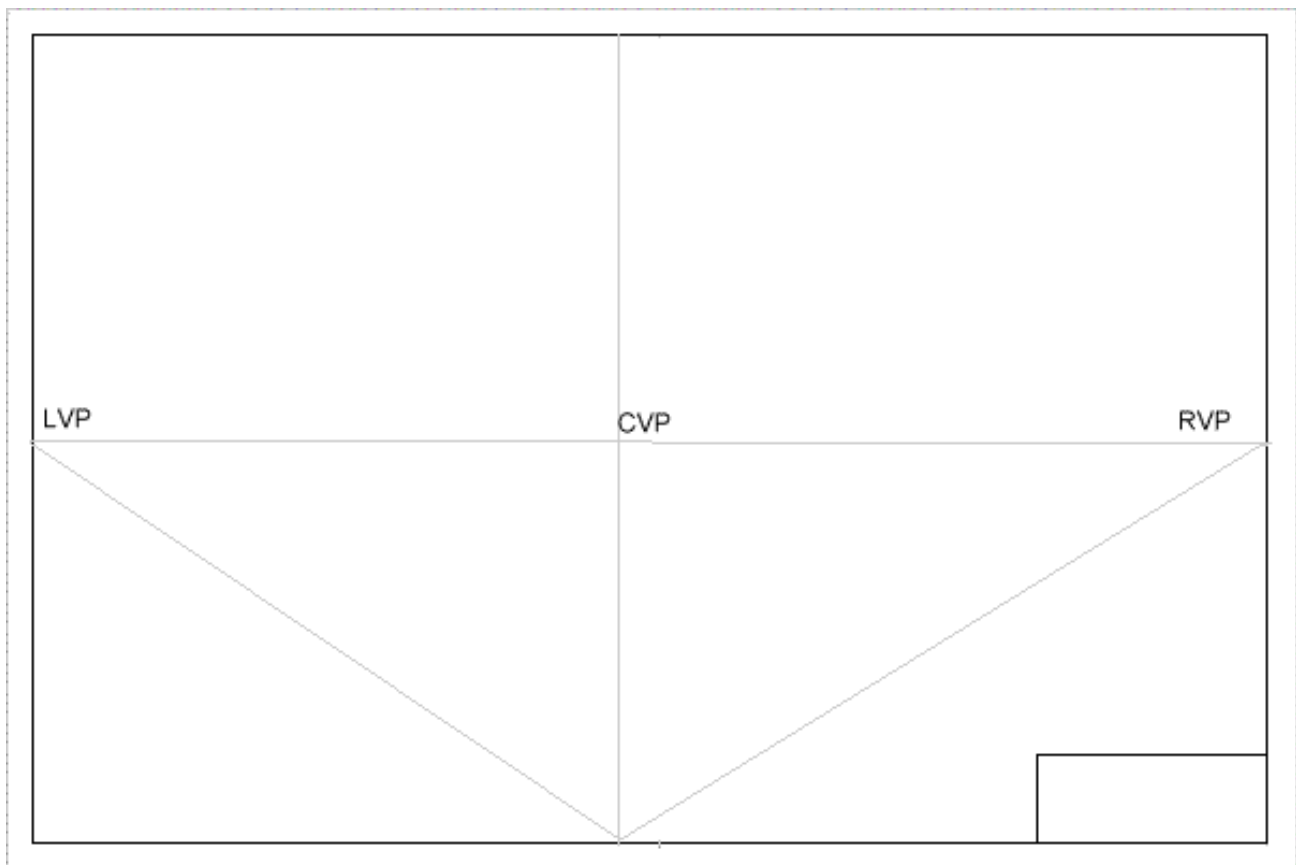

a) Quarter the page as shown with light lines then add the two additional lines as shown.

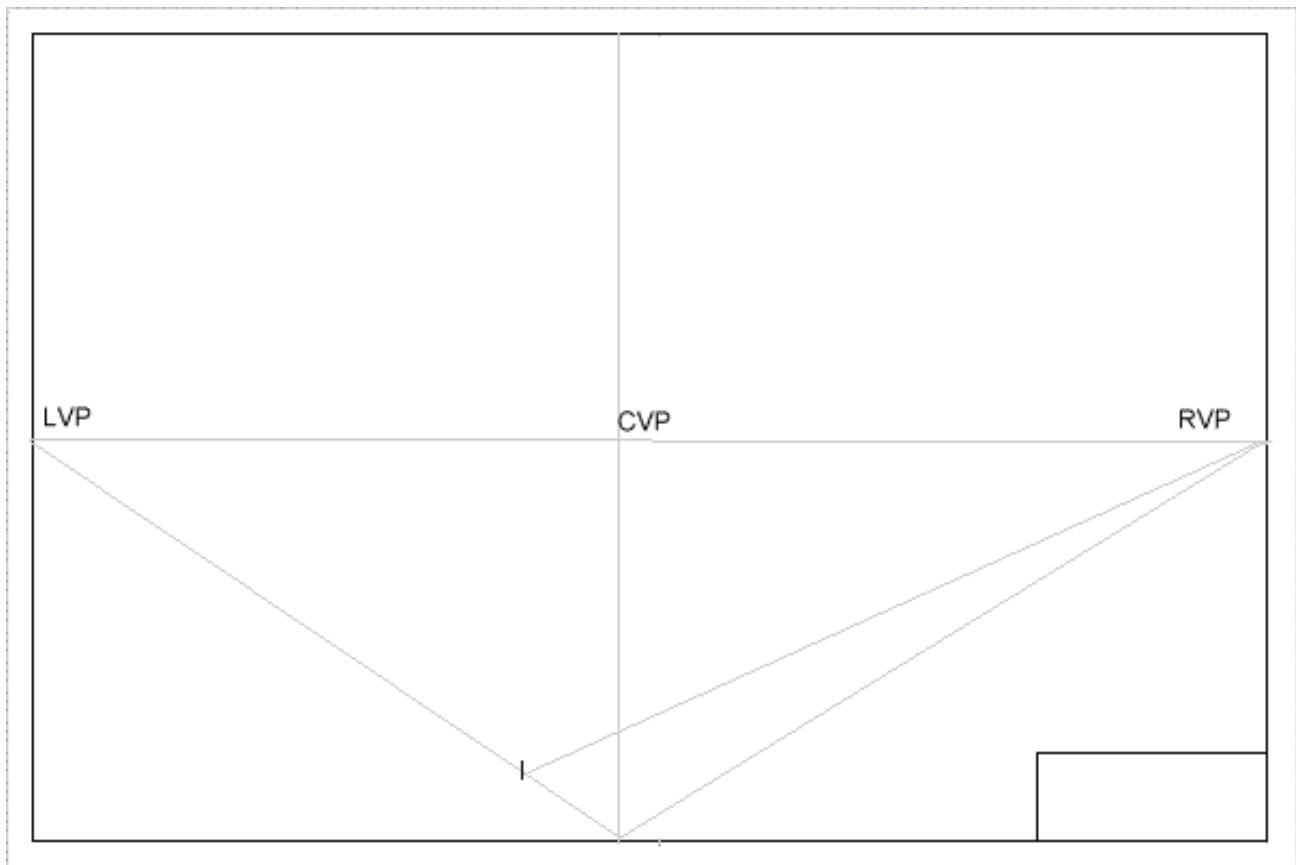

b) Measure a set distance up as shown 30mm (1,1/4") and join to RVP as indicated.

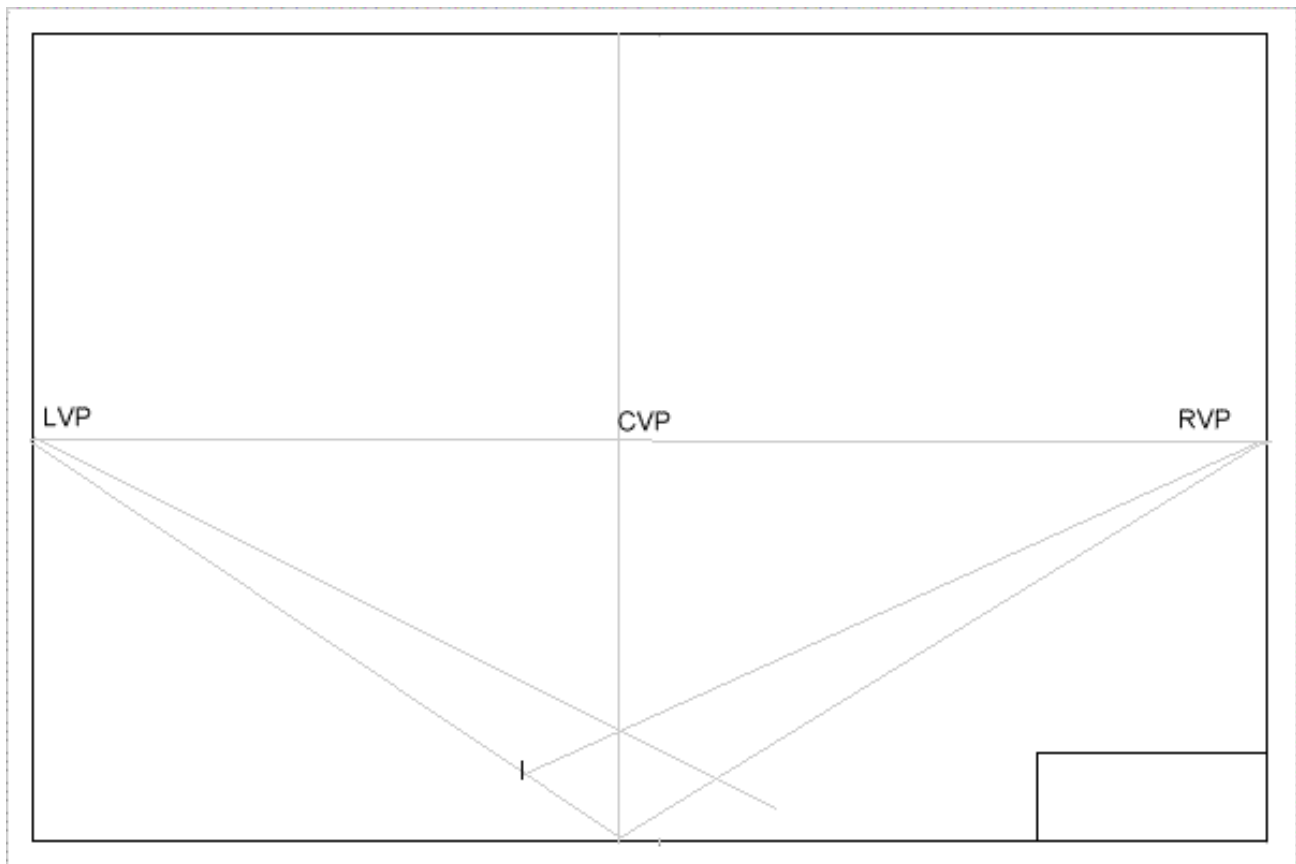

c) Where that line intersects the vertical line down from CVP construct light line from LVP as in the drawing.

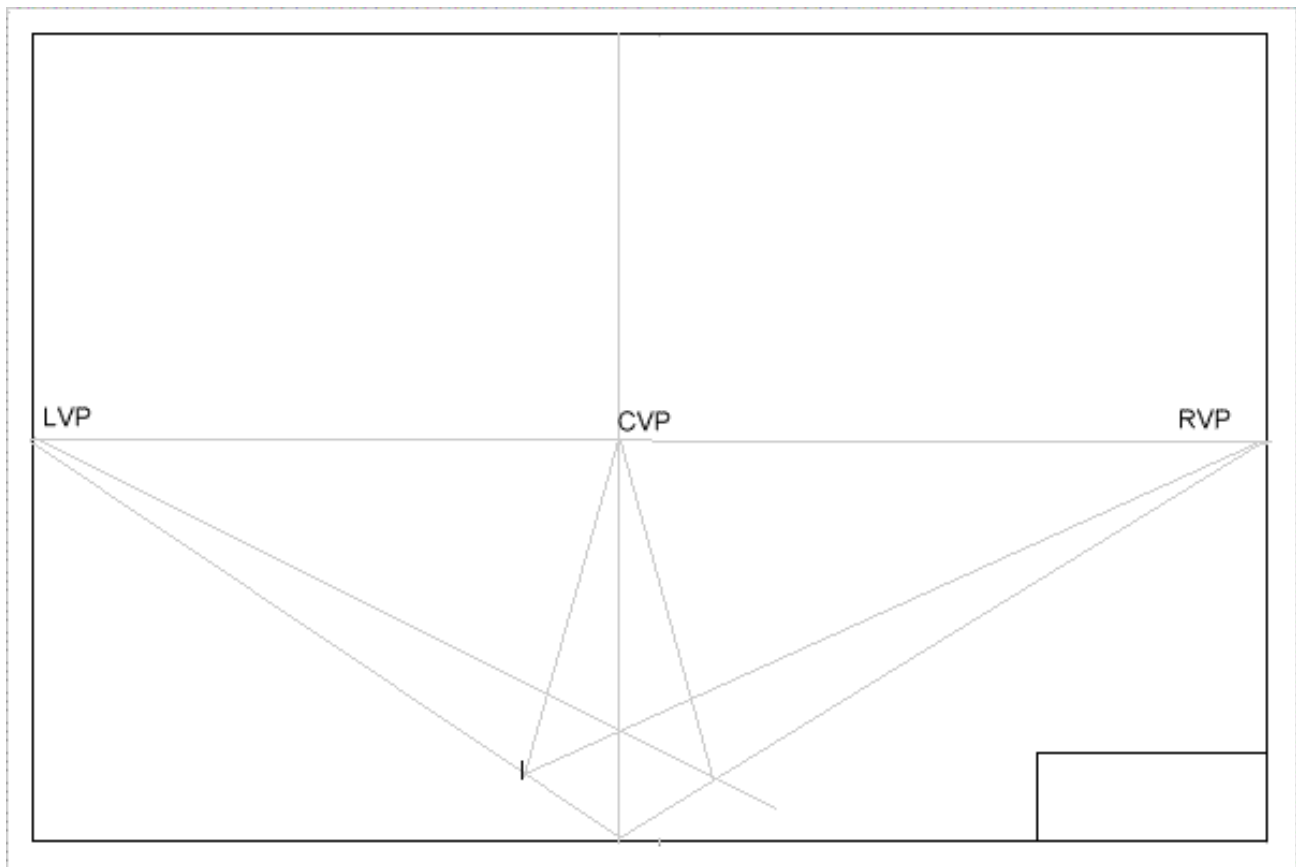

d) Join the two lines to the CVP as shown.

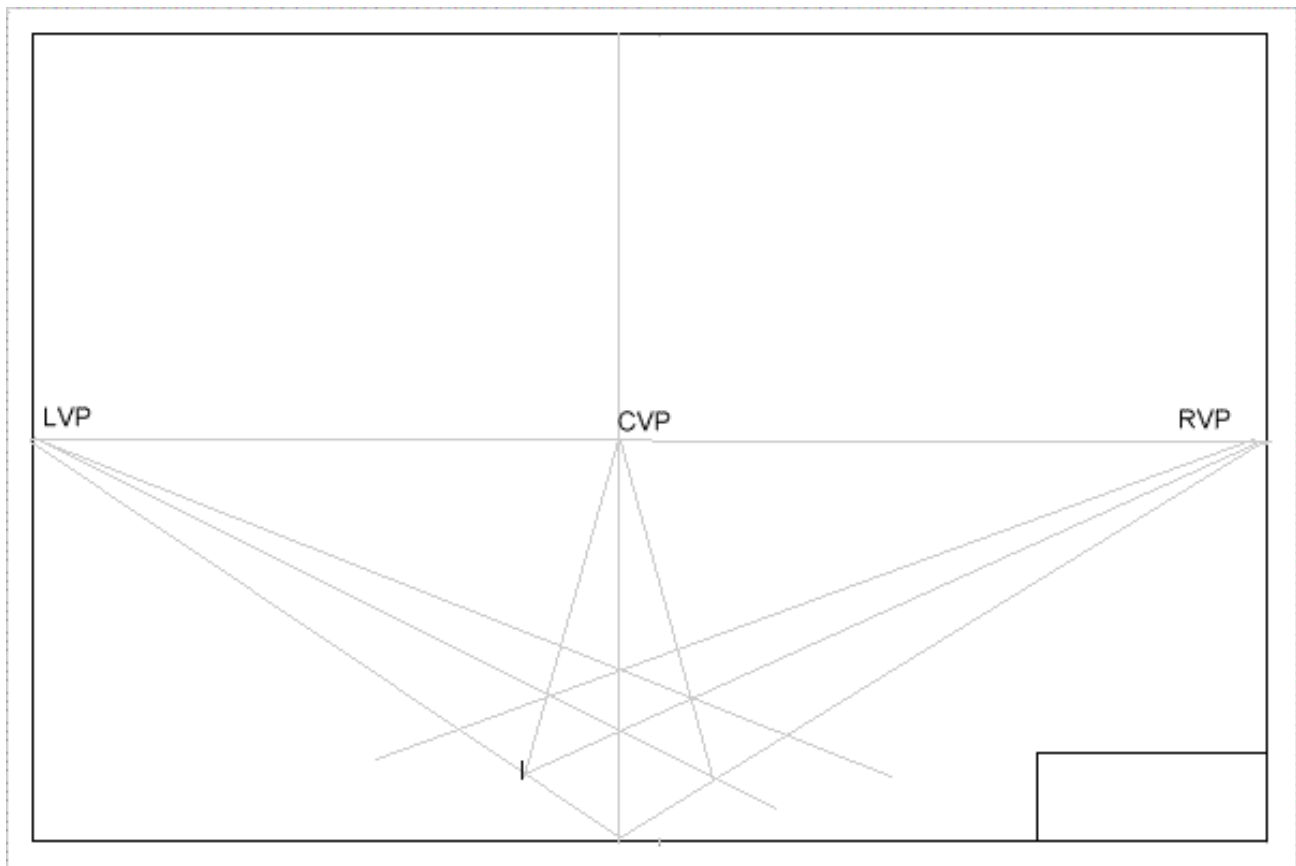

e) Add the two extra light lines from LVP and RVP. We have now drawn four squares on the ground. We can now add many more going backwards using the same method of construction.

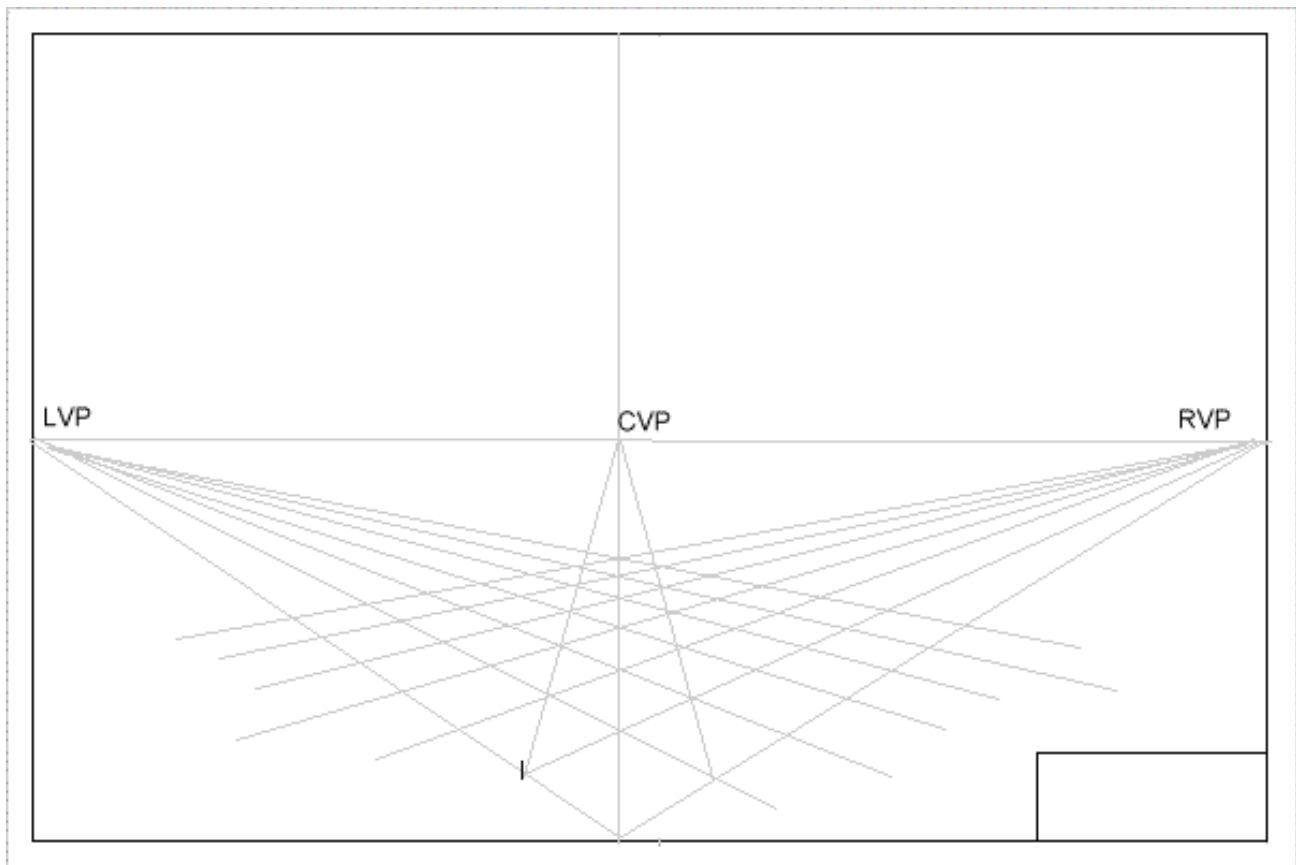

f) We now have 36 squares.

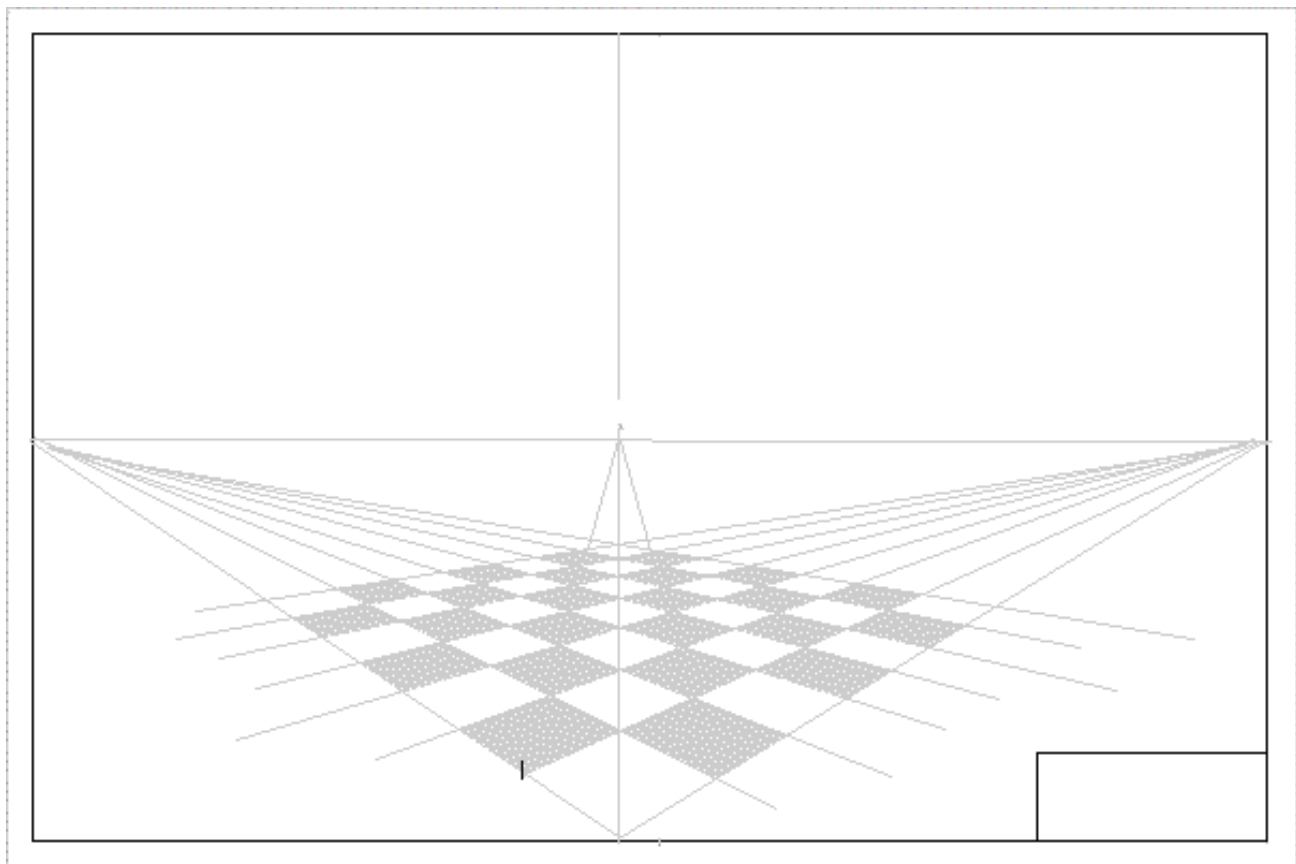

g) Shade the alternate squares as shown. Now we have made a floor. At this stage the student needs to be asked:

- Are the squares of 'equal' size?
- Why are the ones at the back smaller than the ones at the front?
- What happens to parallel lines when we draw them in 'perspective'?
- Is this what the eye or the camera sees?

Next we shall suggest some walls.

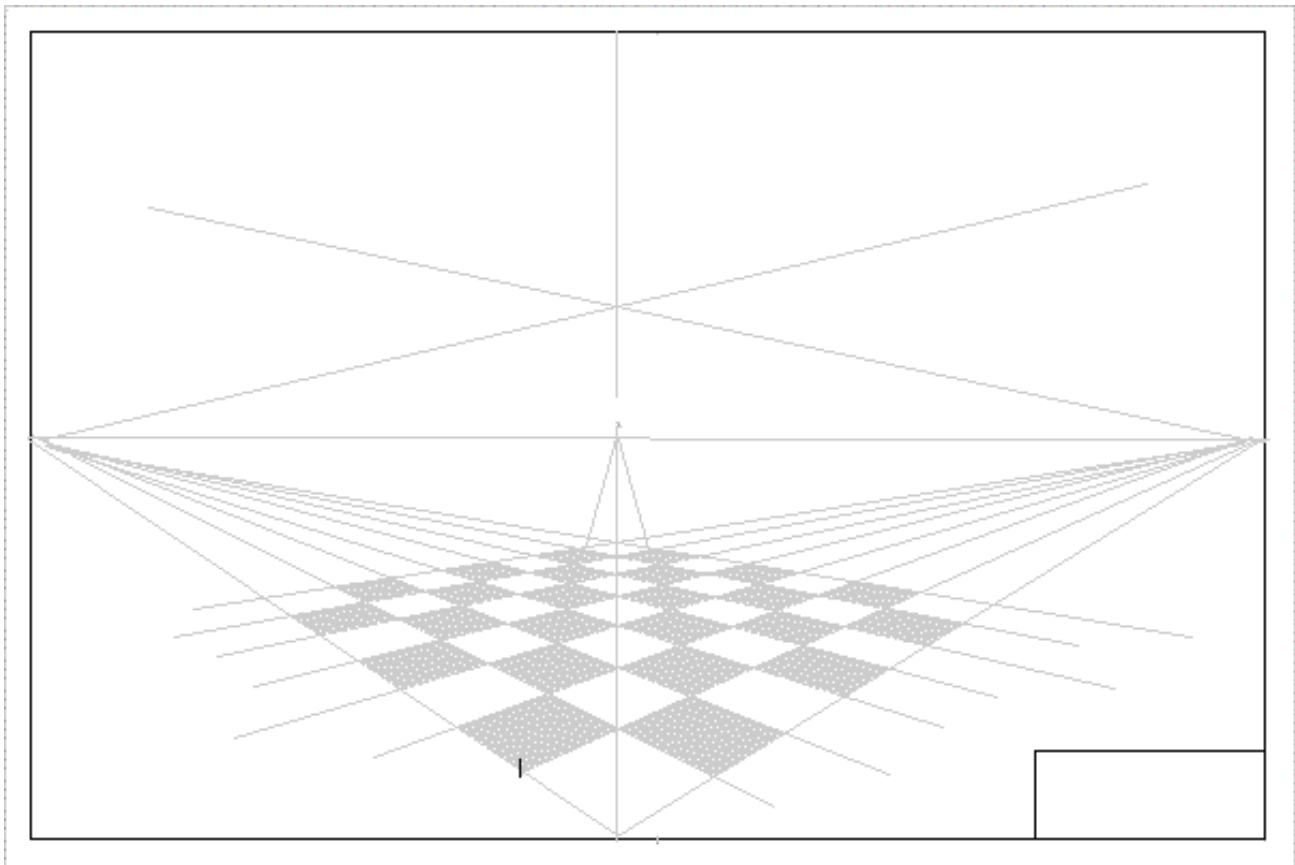

h) Add the two extra light lines 40mm (1,1/2") up from dead center

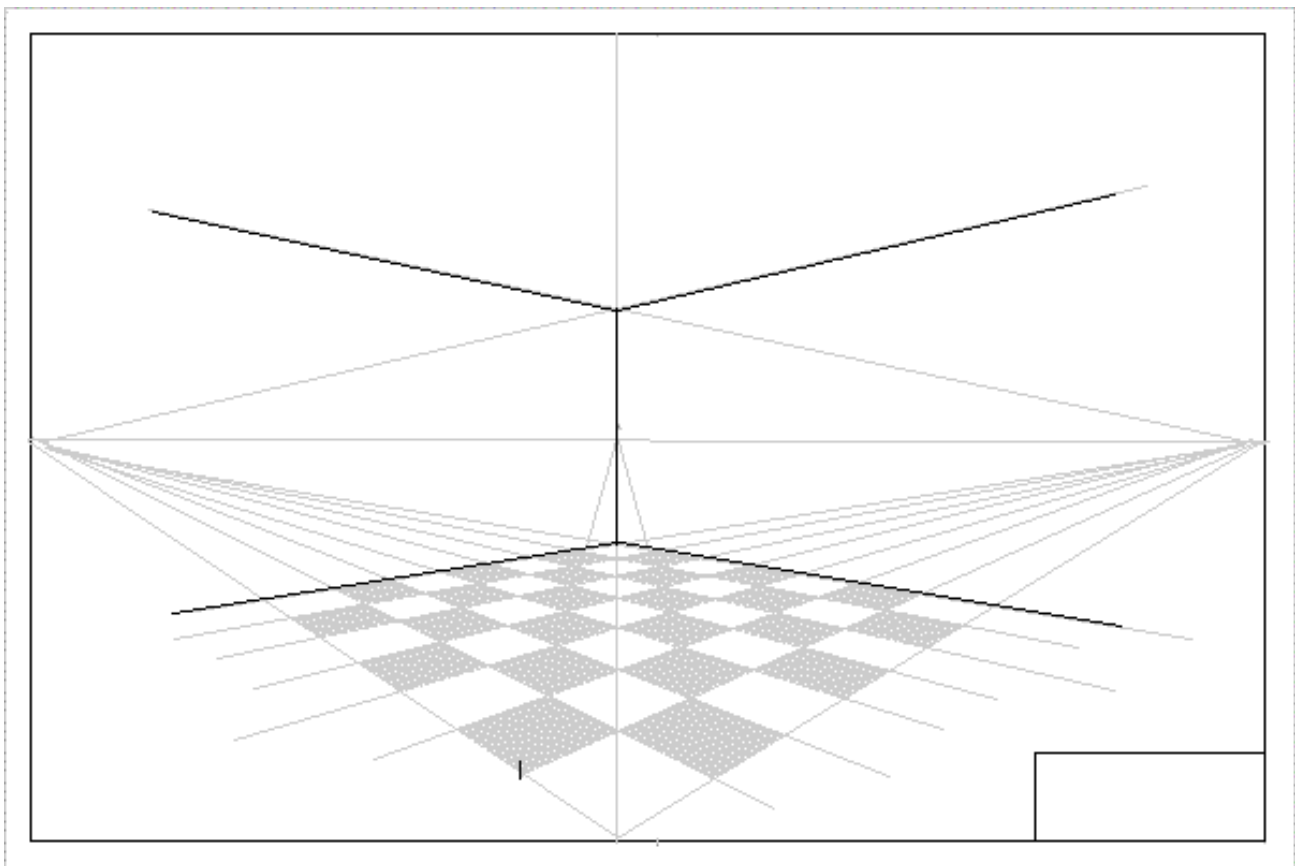

i) Firm in the walls.

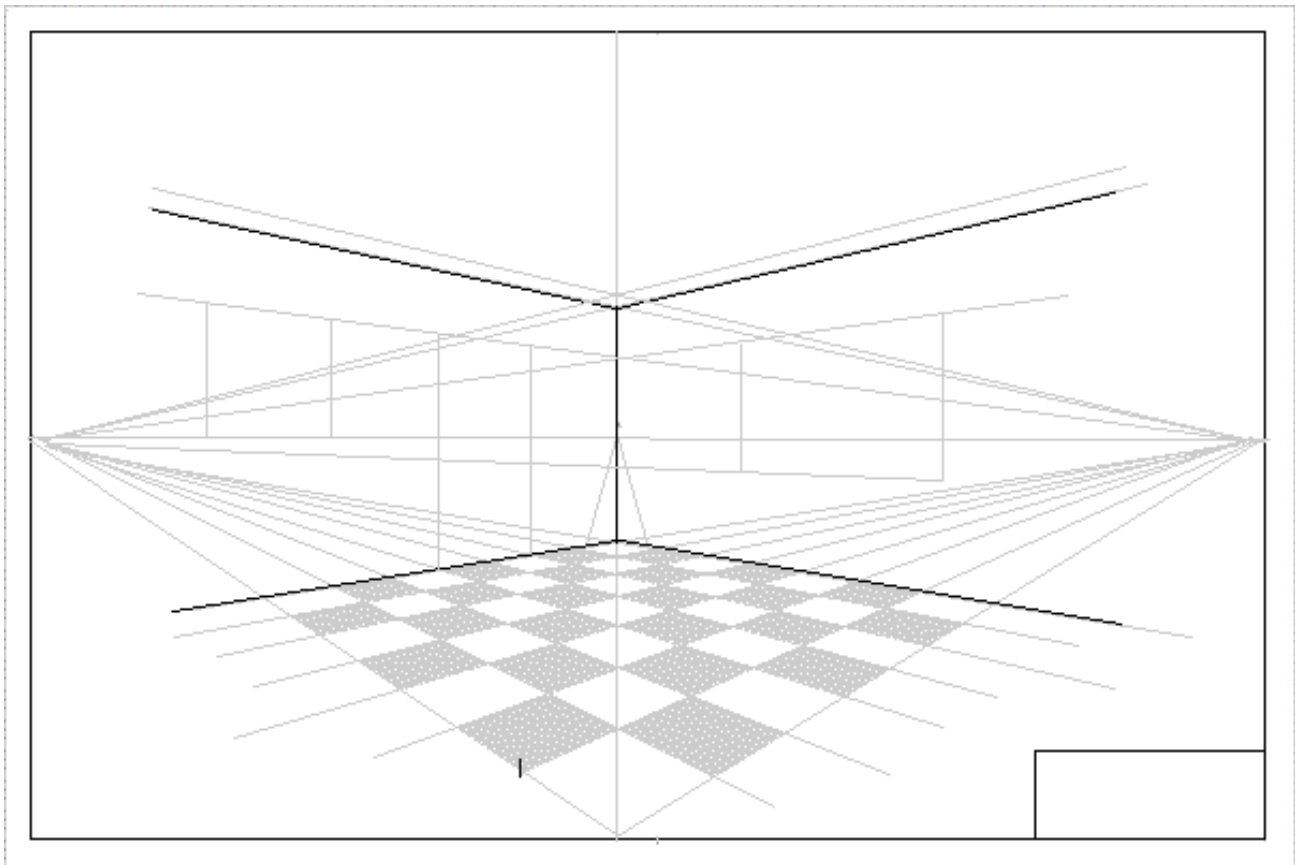

j) Using only vertical lines and lines going to RVP or LVP lightly construct some windows and a door.
Ask:
- how could the room be made larger? (answer - lowering the ceiling).

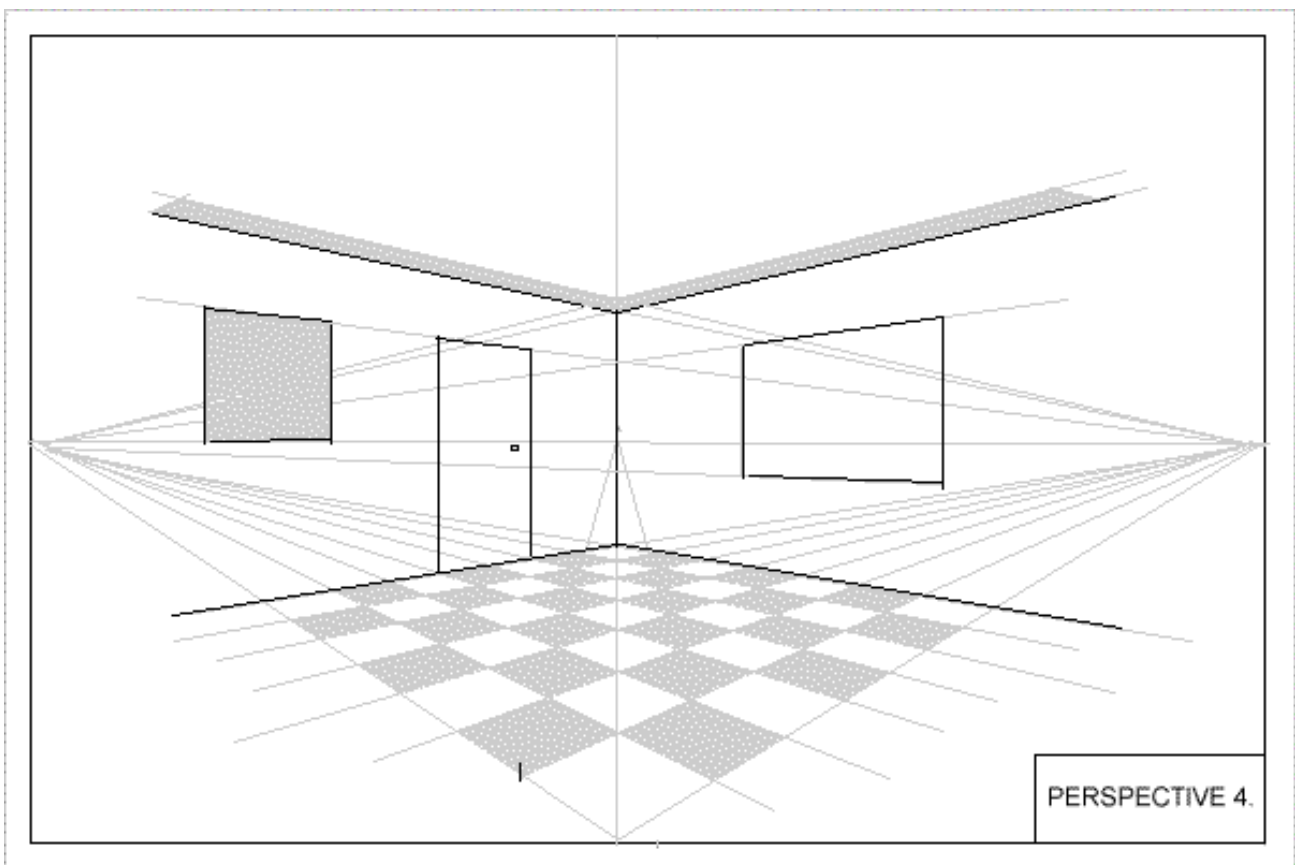

PERSPECTIVE 4.

k) Firm them in and add a door knob and a little shading on the ceiling. Ask:
- How do we know how high to make the door? (stress the importance of observation and look around the classroom for clues).
Is the door handle on the right or left side of the door?

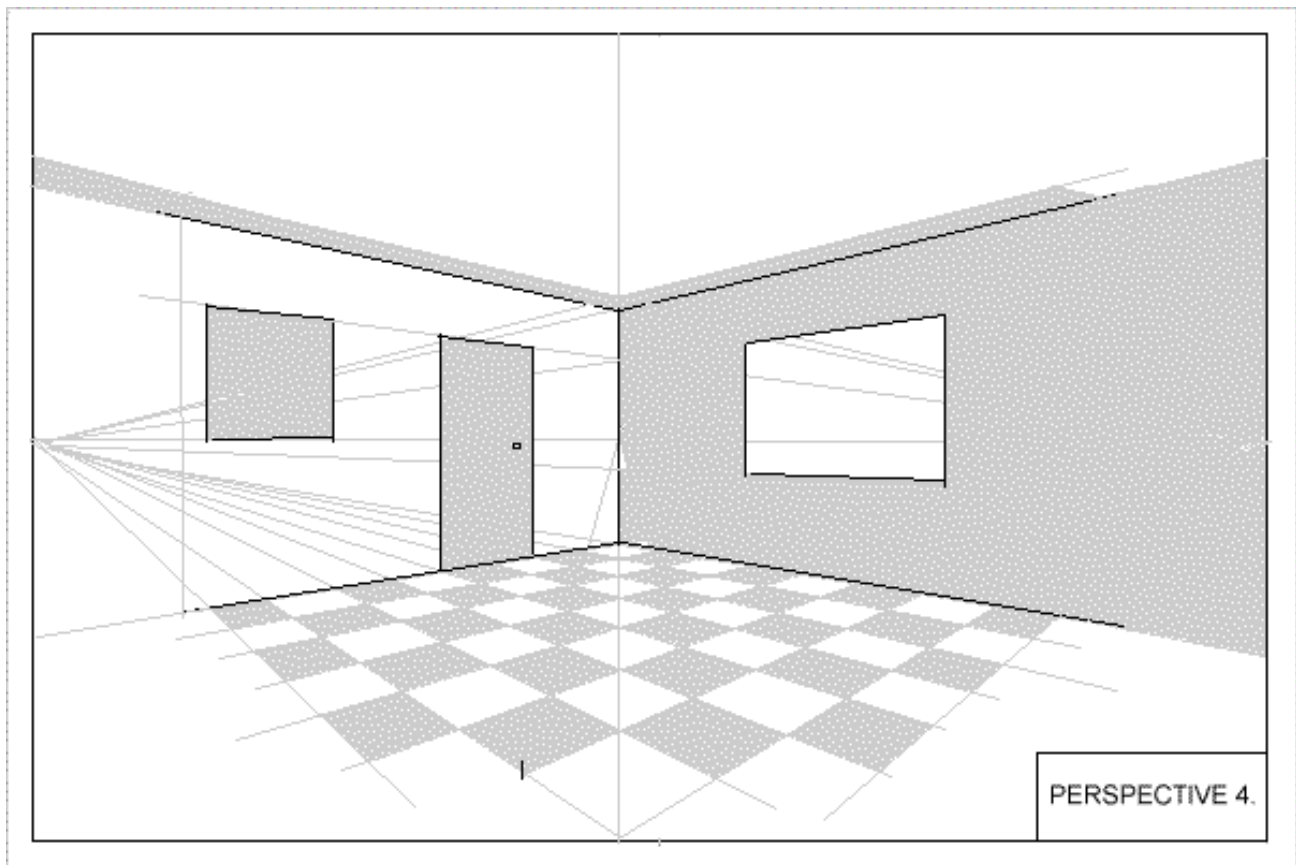

l) I have added some more tiles (see if the student can do this by 'judgement') - an extra row on the right and one on the left - and shaded the door.

Clean up and print in the title as shown.

You will find some students will grasp the ideas and concepts faster than others. Instead of having them idle, and waiting, they can be encouraged to add extra detail of their own choosing. That is the beauty of this type of lesson; it is open ended. Encourage the more advanced student to add the more complicated items.

Home work:

Complete the drawing adding a painting on the wall, curtains, light on the ceiling, a chair or table ... etc.



[GO TO ... LESSON FIVE](#) [lesson menu](#)



LESSON - PERSPECTIVE FIVE - WESTERN RAILWAY

TIME:

Allow 40min

Aim:

To create a perspective grid using a single measurement and three vanishing points. This lesson is to consolidate and further the notion of perspective 'scale'. That is, as things of equal size recede they appear smaller. This time we will use the CVP and a familiar and logical structure, a railway line.

Materials:

The sketch pad,
HB pencil, ruler.

Construct margin and title box then:

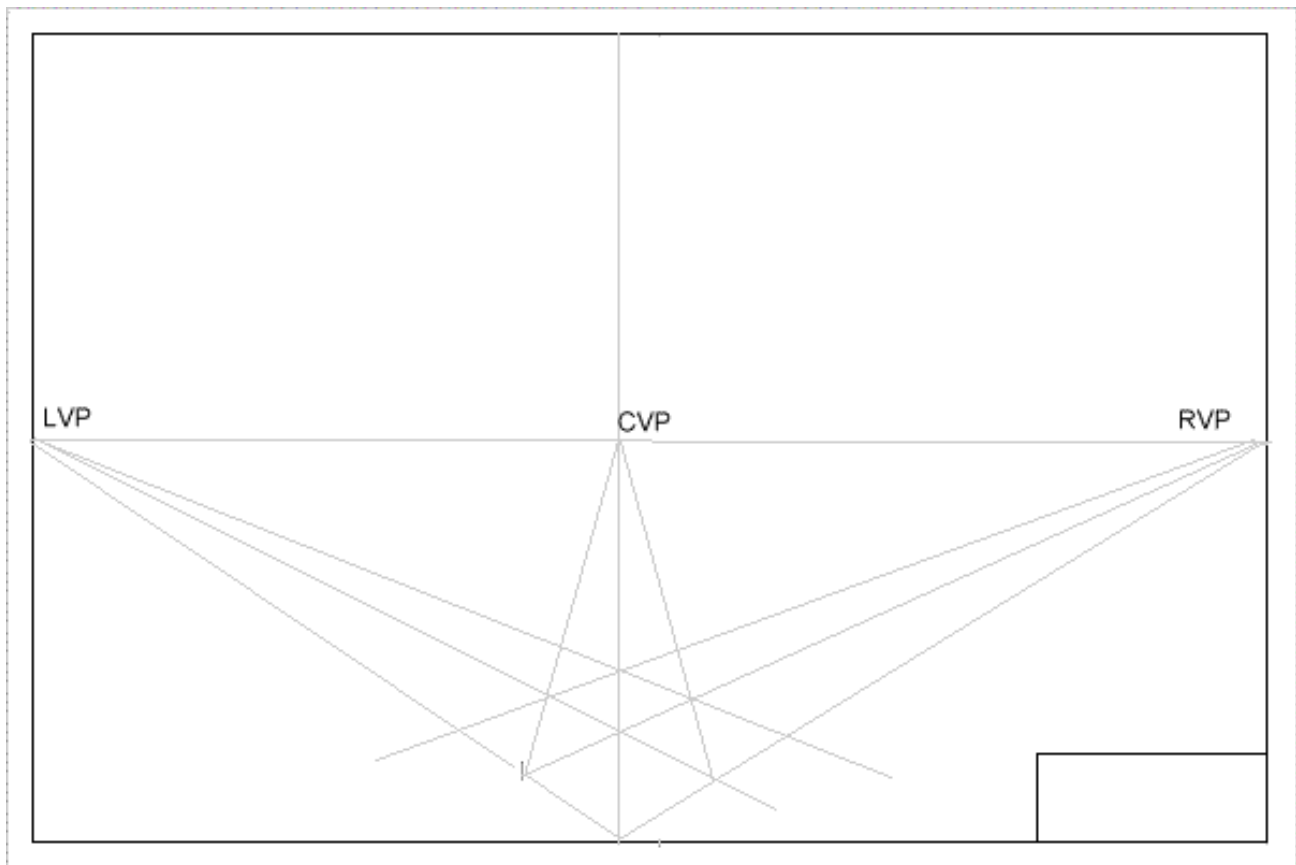

a) Construct the same light lines as in stage a, b, c, d, of the previous lesson until we get the lines shown above.

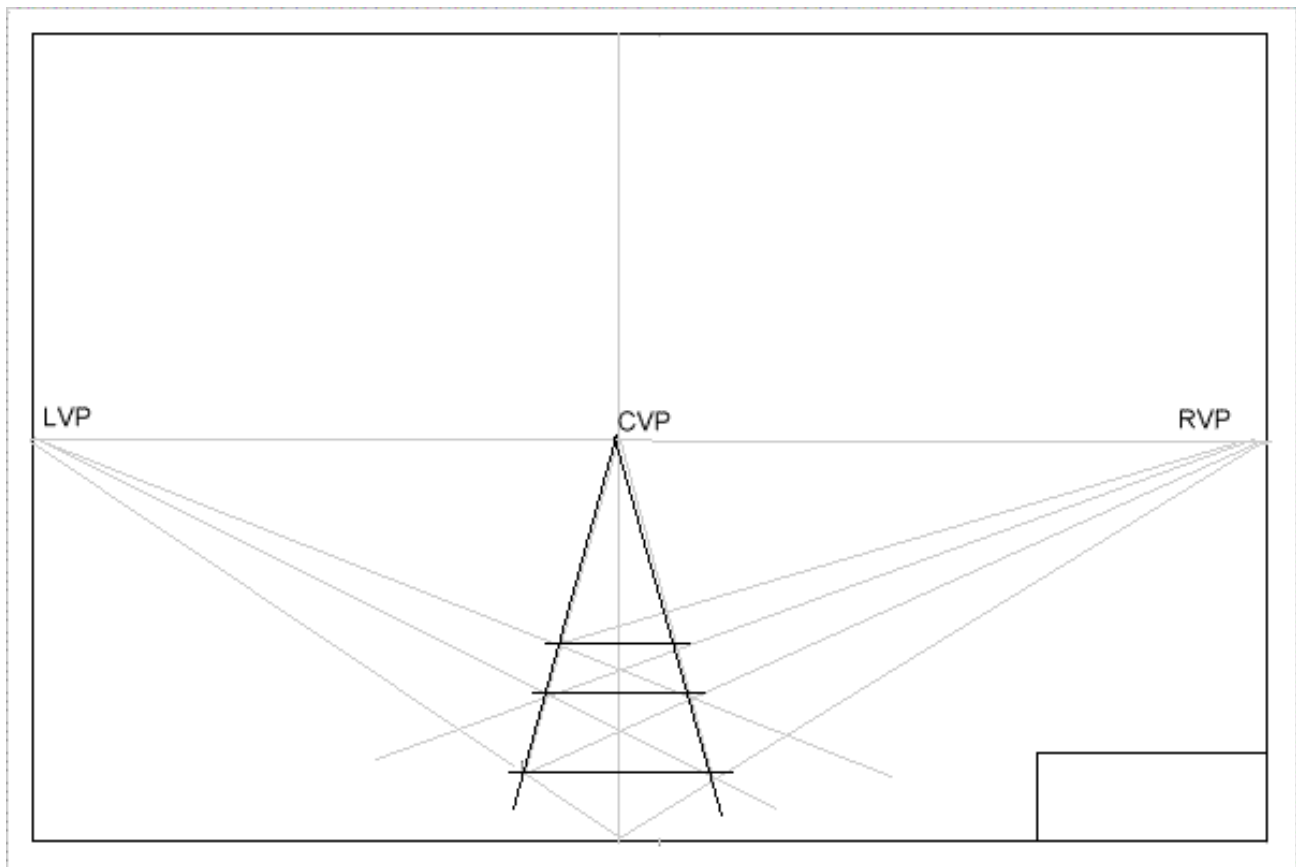

b) This time we firm in the 'diagonals' which become railway line 'sleepers'. Notice here we use a more simplified method of construction.

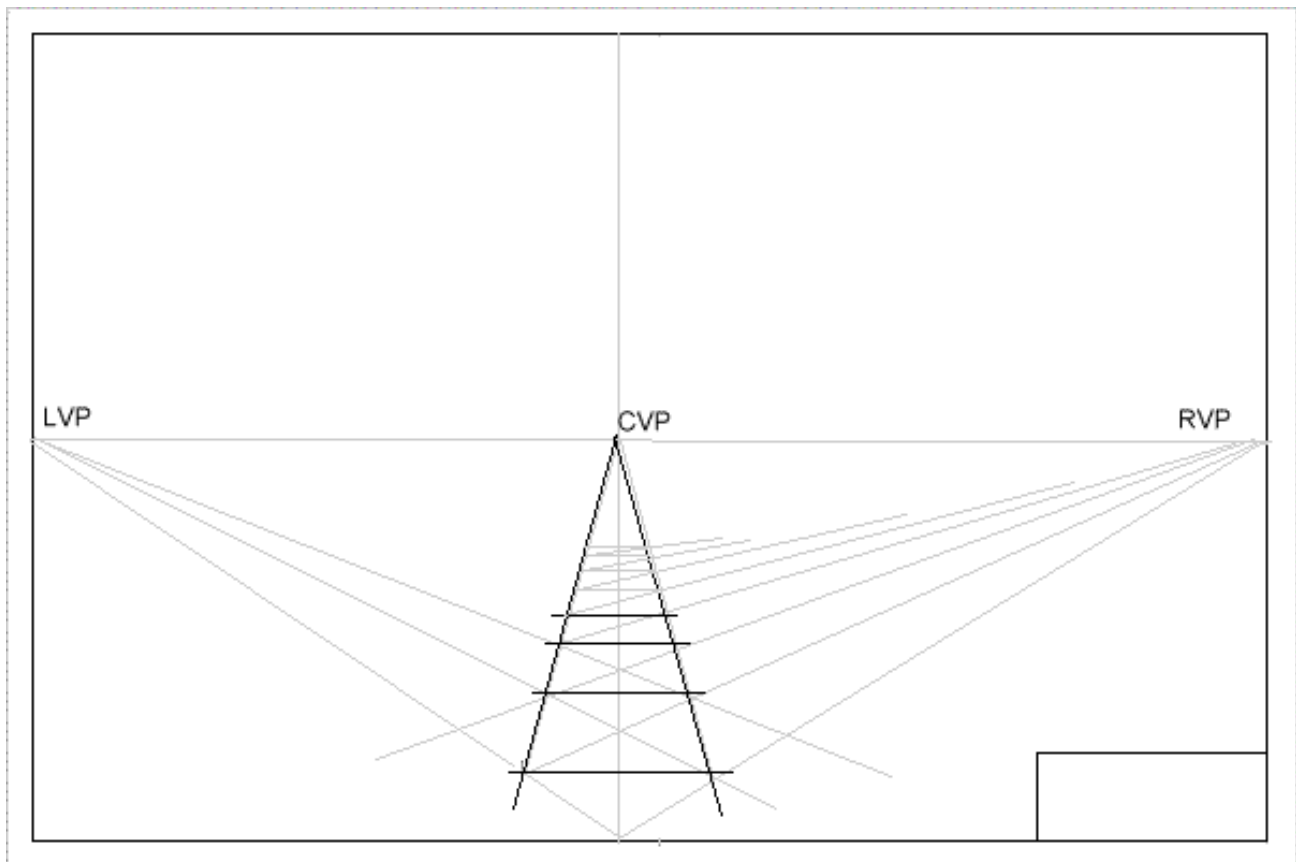

c) Keep adding sleepers.

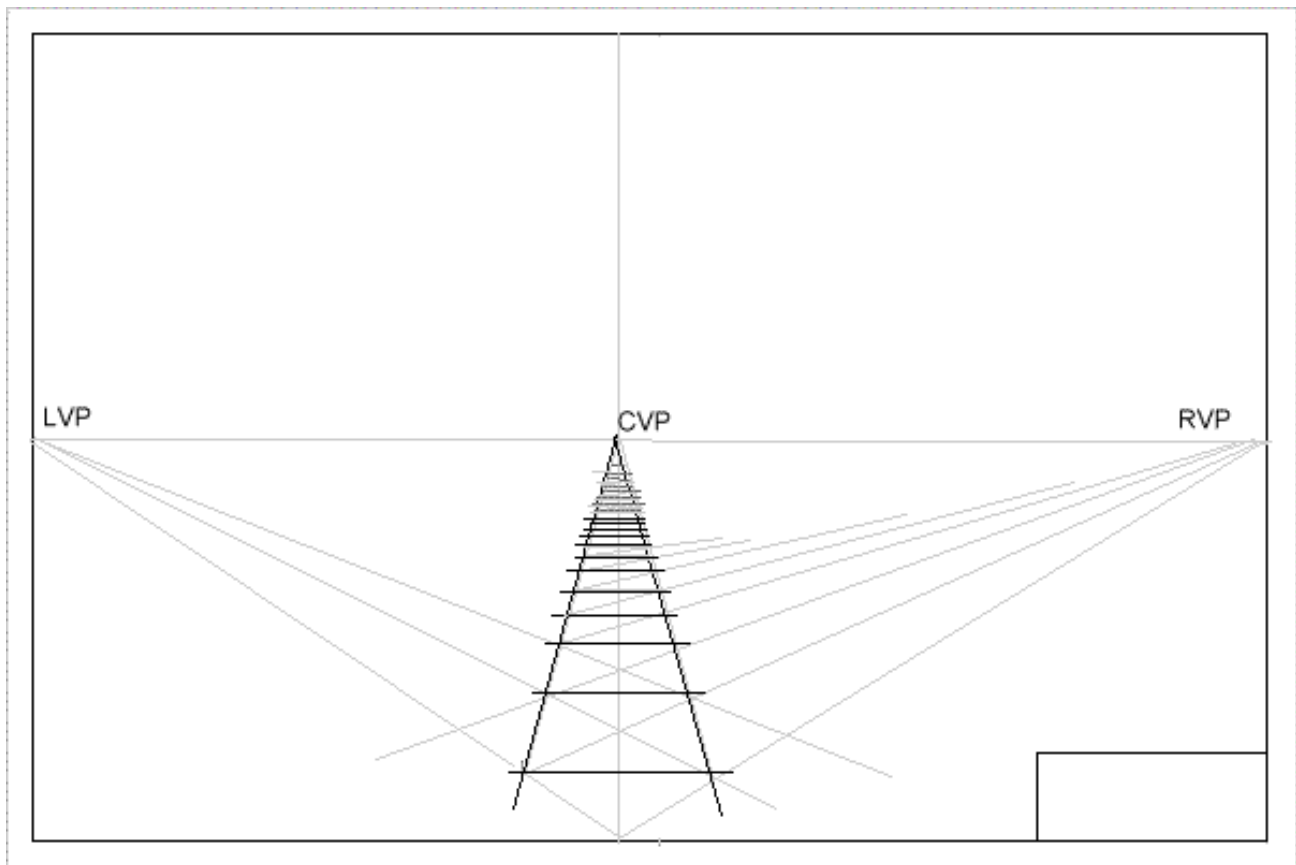

- d) After the student has completed the drawing to the stage above ask:
What shall we call the line that joins LVP, RVP and CVP? (answer 'horizon line').
How wide are railway tracks? (remember the old movies of people tied to railway lines? - answer about 5feet).
If the distance between the sleepers is 5 feet what is the distance between the second and fourth sleepers?

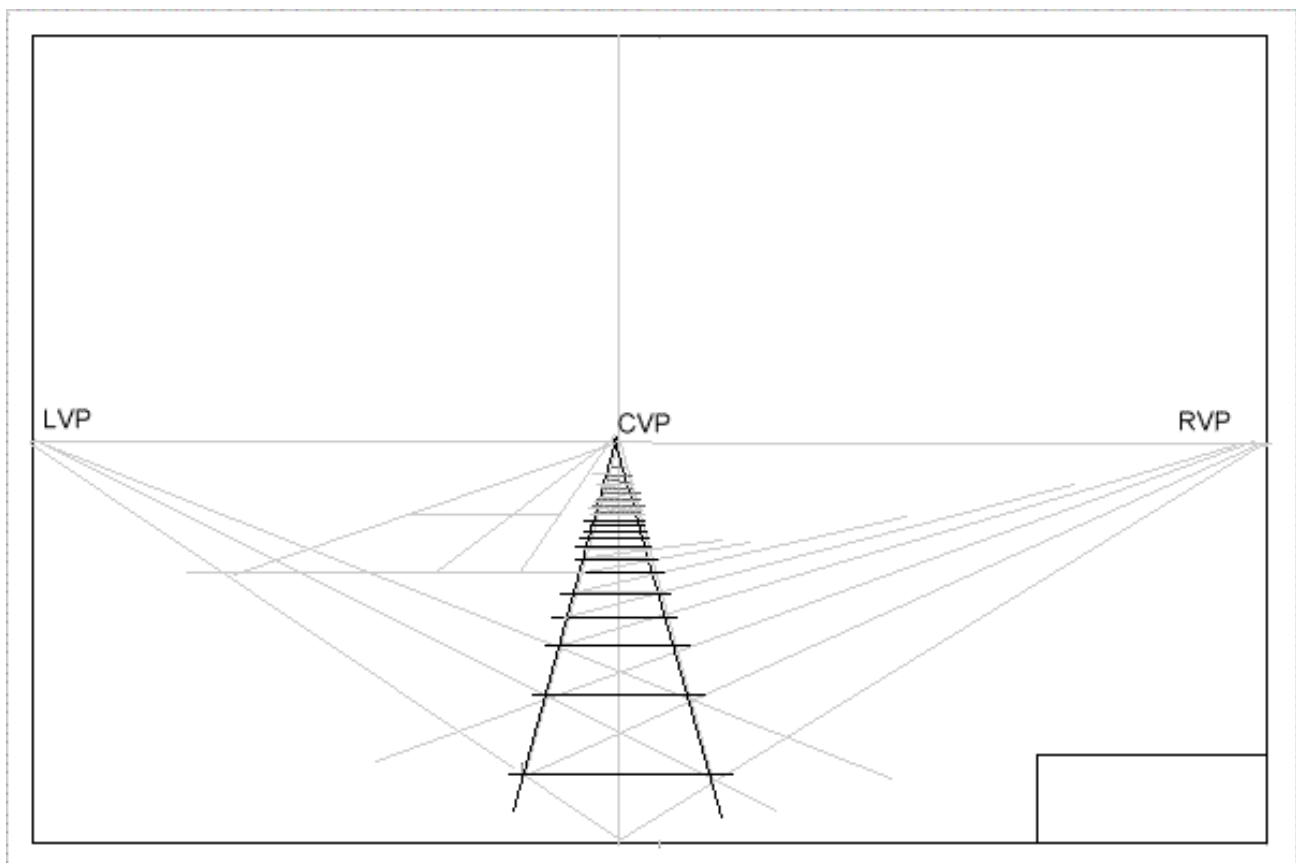

- e) Add the extra light lines on the ground (two horizontal and three to the CVP). We are going to build a station about 30mm (1,1/4") from track 60mm wide.

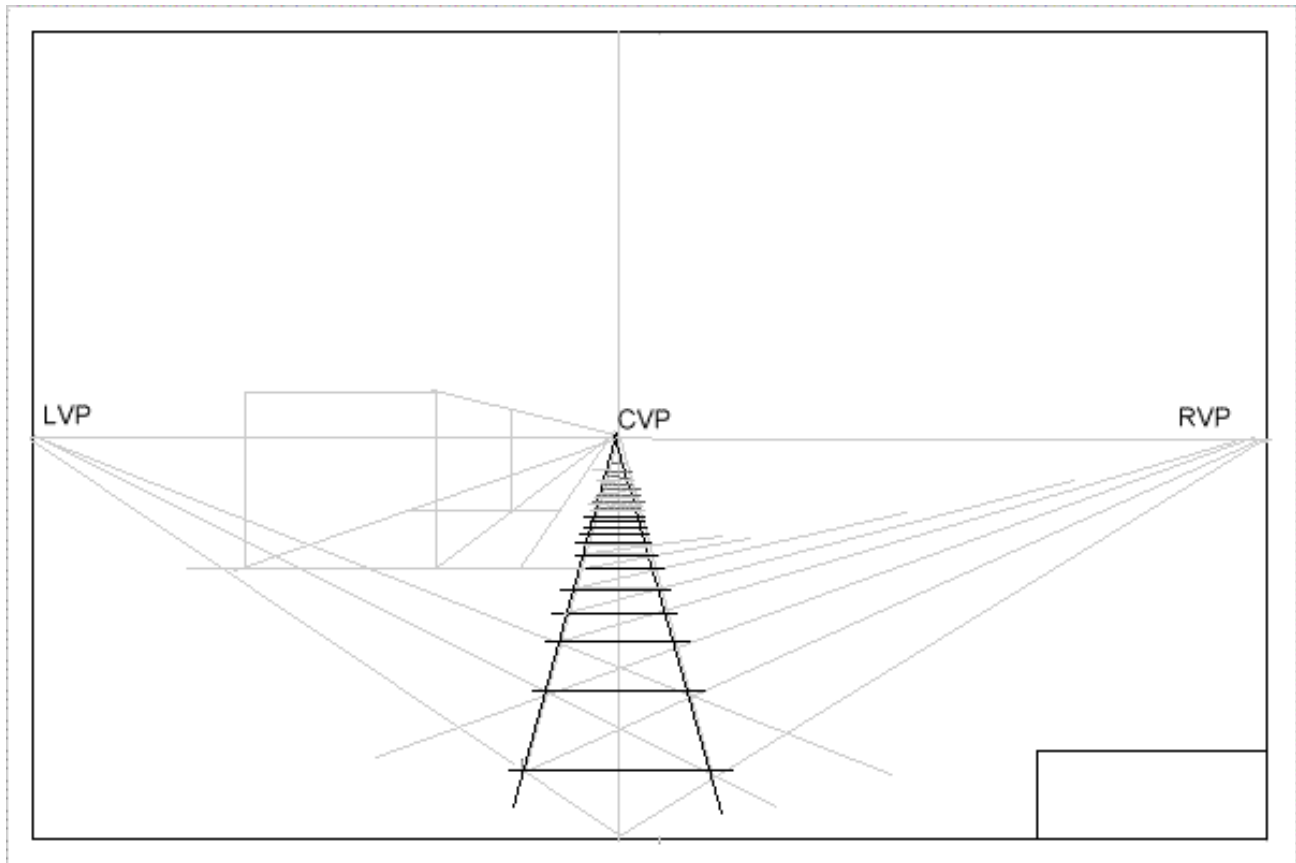

f) Add the vertical lines 50mm (2") high and join to CVP

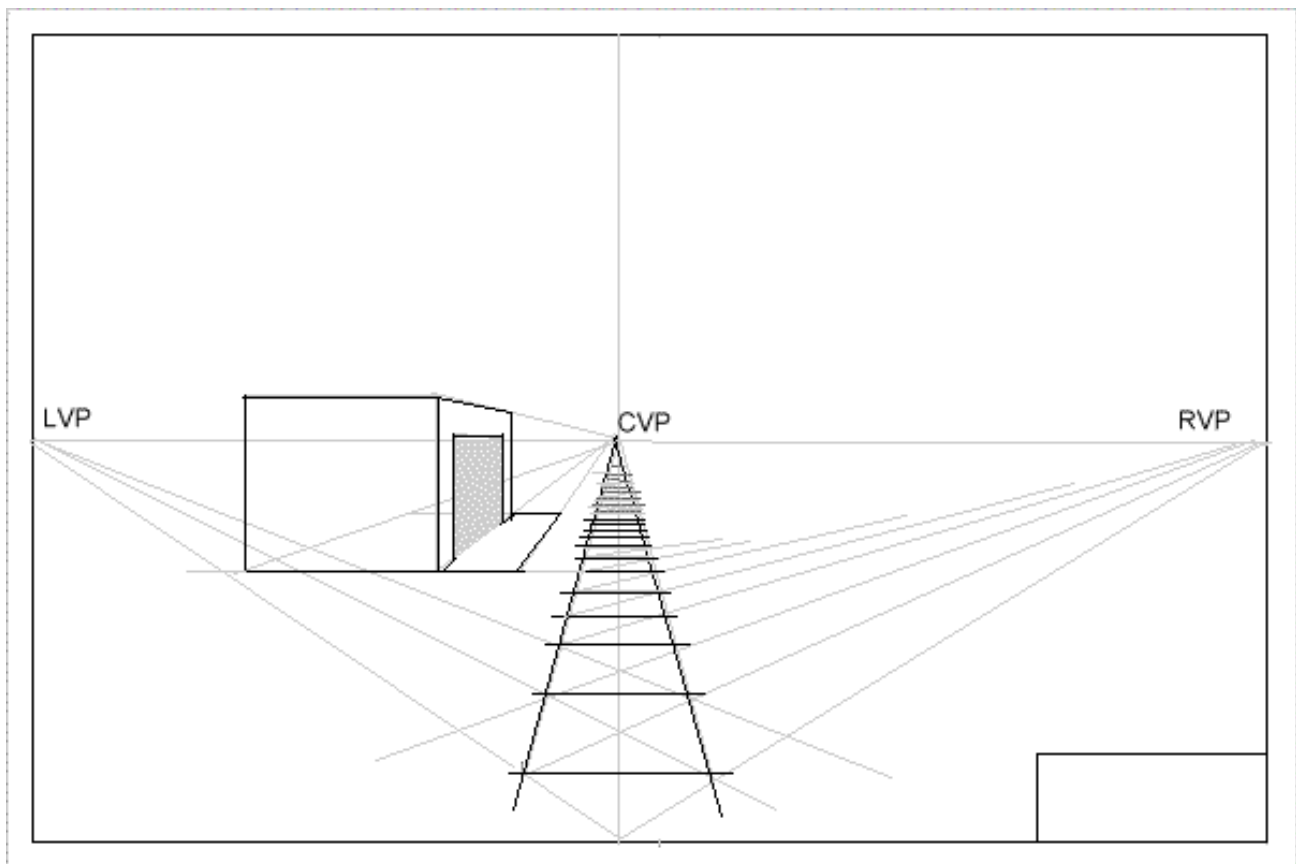

g) Firm in the lines as shown and ask:
How high is the building? The student should measure the width of the tracks on the line directly opposite the front edge of the station and apply that 'scale' to the building's height. **Objects an equal distance away from the 'observer' are subject to the same measurements of 'scale' at that distance.** In this drawing the scale is discovered by knowing the width of the track at that

distance.

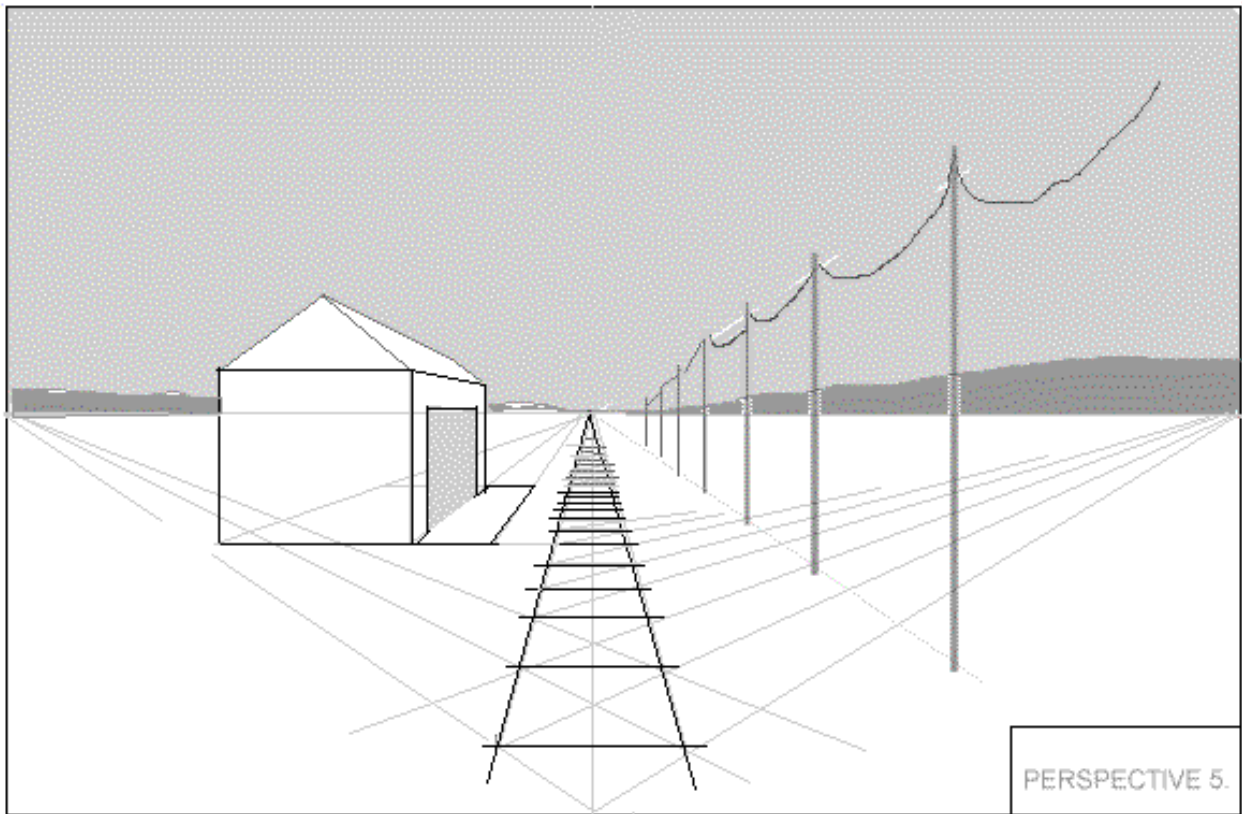

h) Add the telegraph lines and poles and have the student determine their height and distance apart.

Clean up and print in the title as shown.

Encourage the advanced students to add three 12 foot cacti at various locations in the landscape.

Home work:

Complete the drawing adding a roof on the station, cactus, hills , train, and birds etc.

Press [here](#) to see a master work using the CVP (central vanishing point) perspective.



[GO TO ... LESSON SIX](#)

[lesson menu](#)



LESSON - PERSPECTIVE SIX- ROOM INTERIOR (CVP)

TIME:

Allow 60-80min - this is a double lesson

Aim:

To create a perspective grid using a single measurement and three vanishing points but vanishing toward the CVP. We will also introduce the freehand method of constructing curves.

Materials:

The sketch pad,
HB pencil, ruler.

Construct margin and title box then:

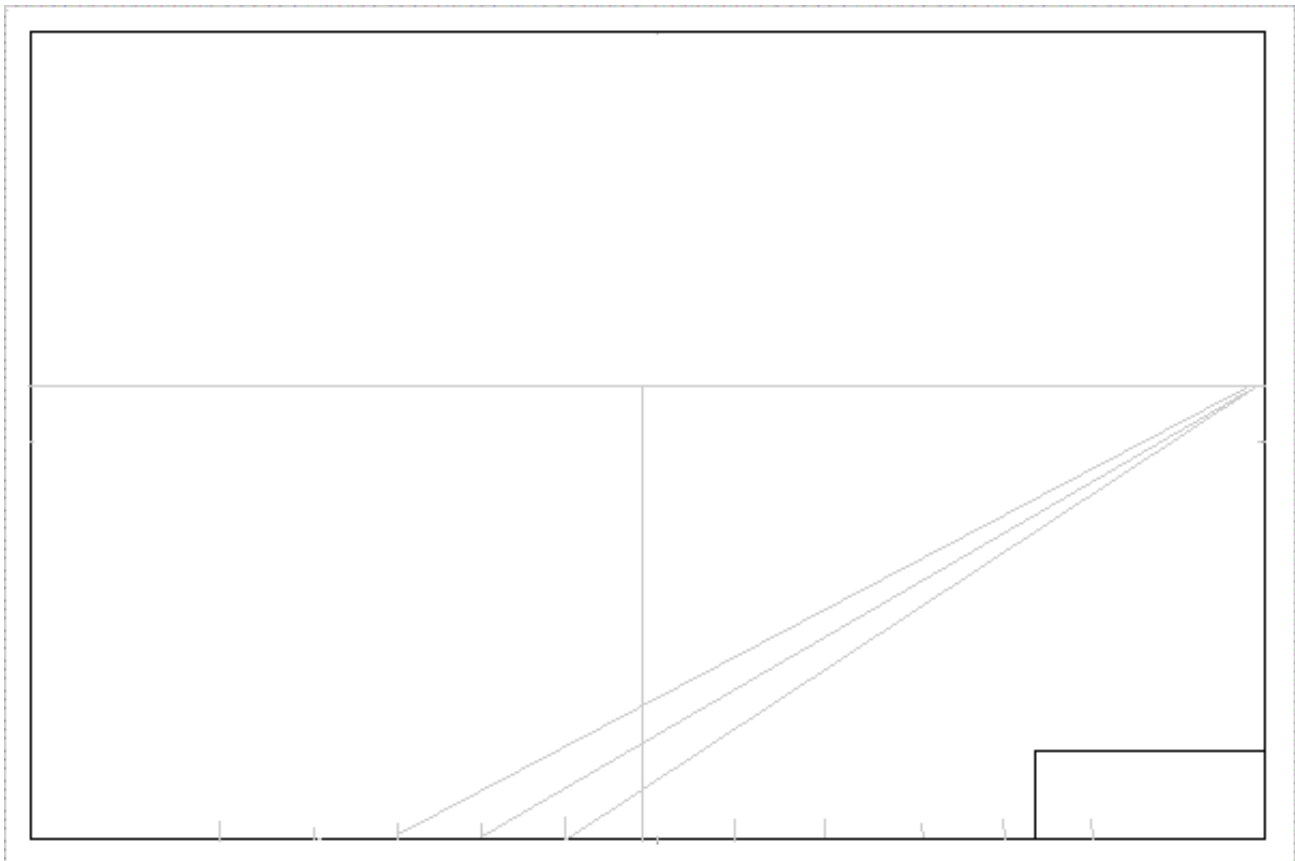

a) Measure intervals of 24mm (1") along the base margin as shown and join to RVP.

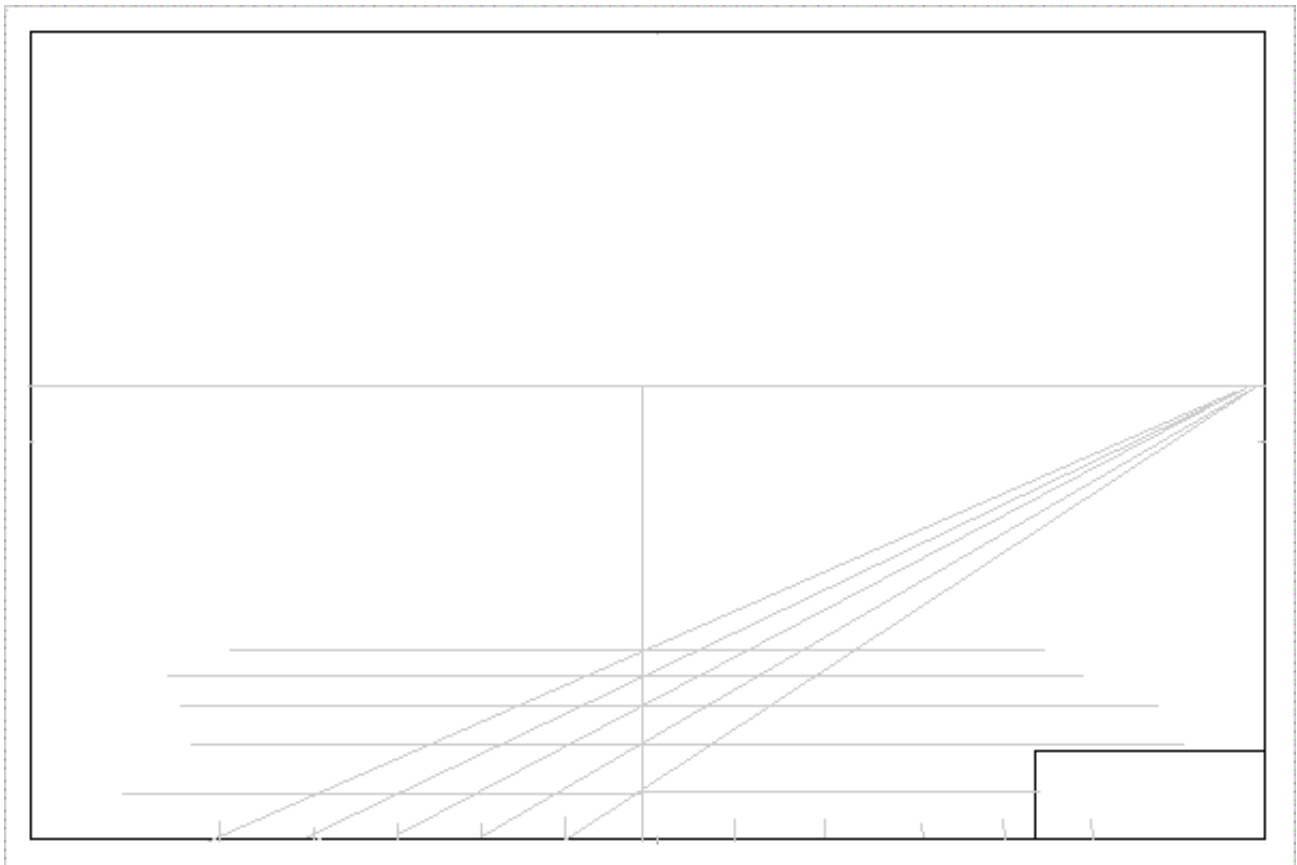

b) Where they cross the vertical line from CVP draw horizontal lines as above.

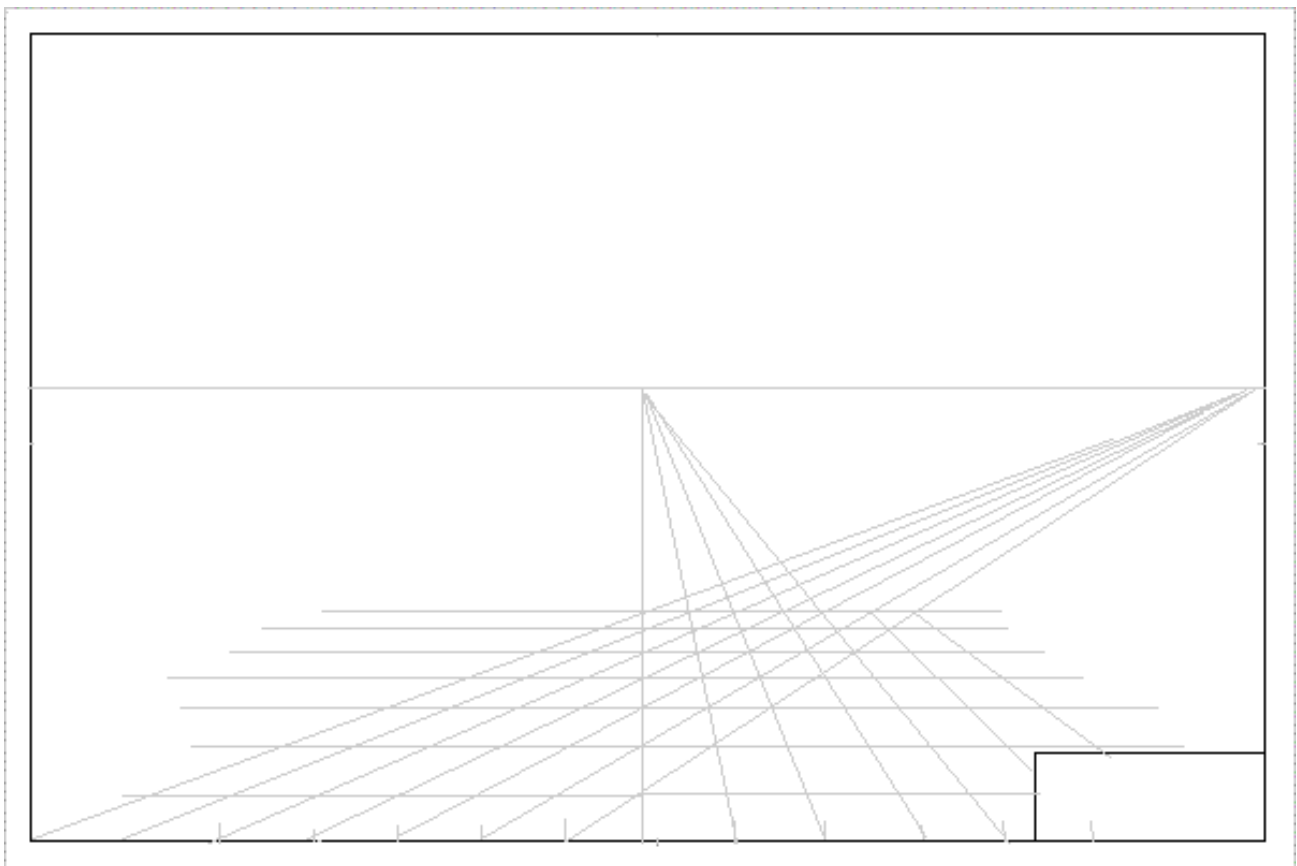

c) Add lines to CVP from marked intervals

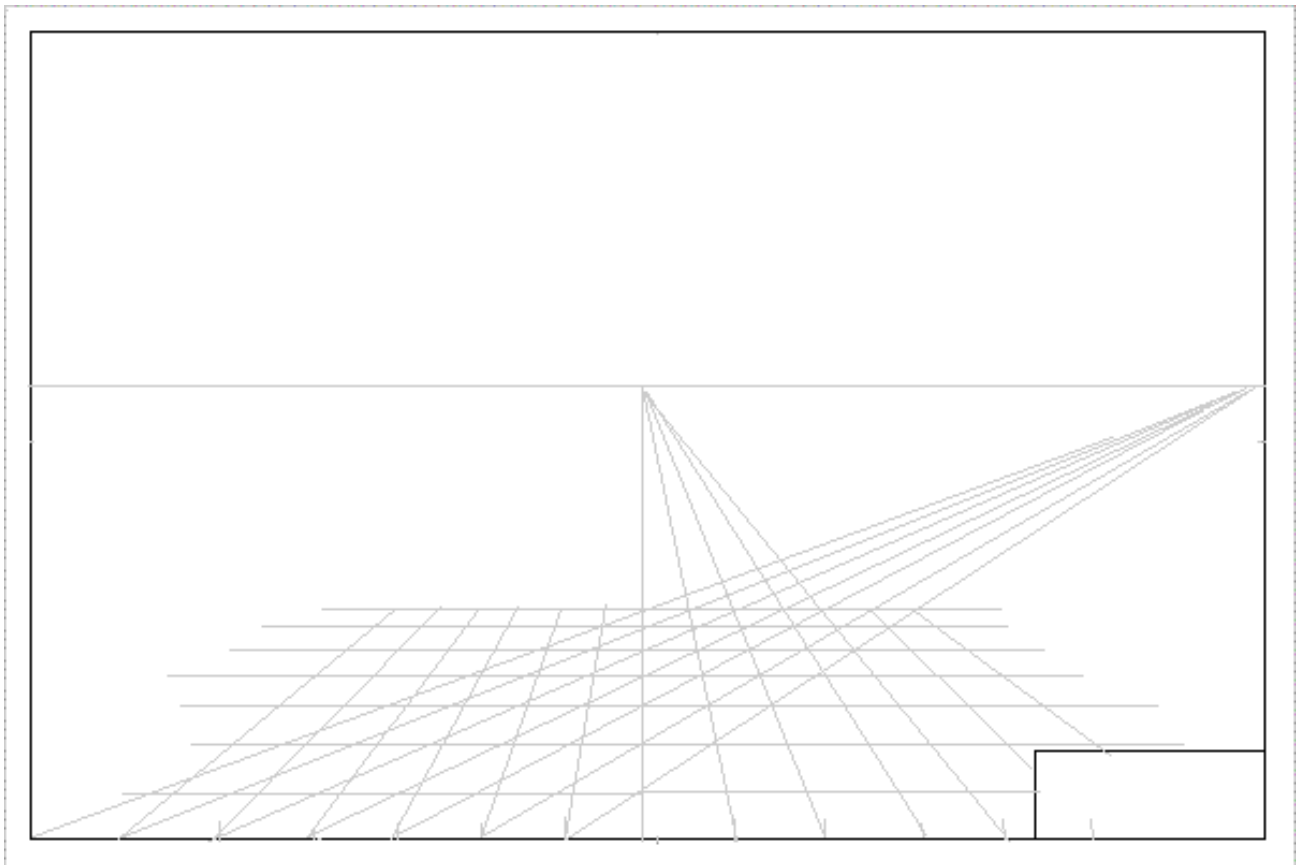

d) Extend and complete.

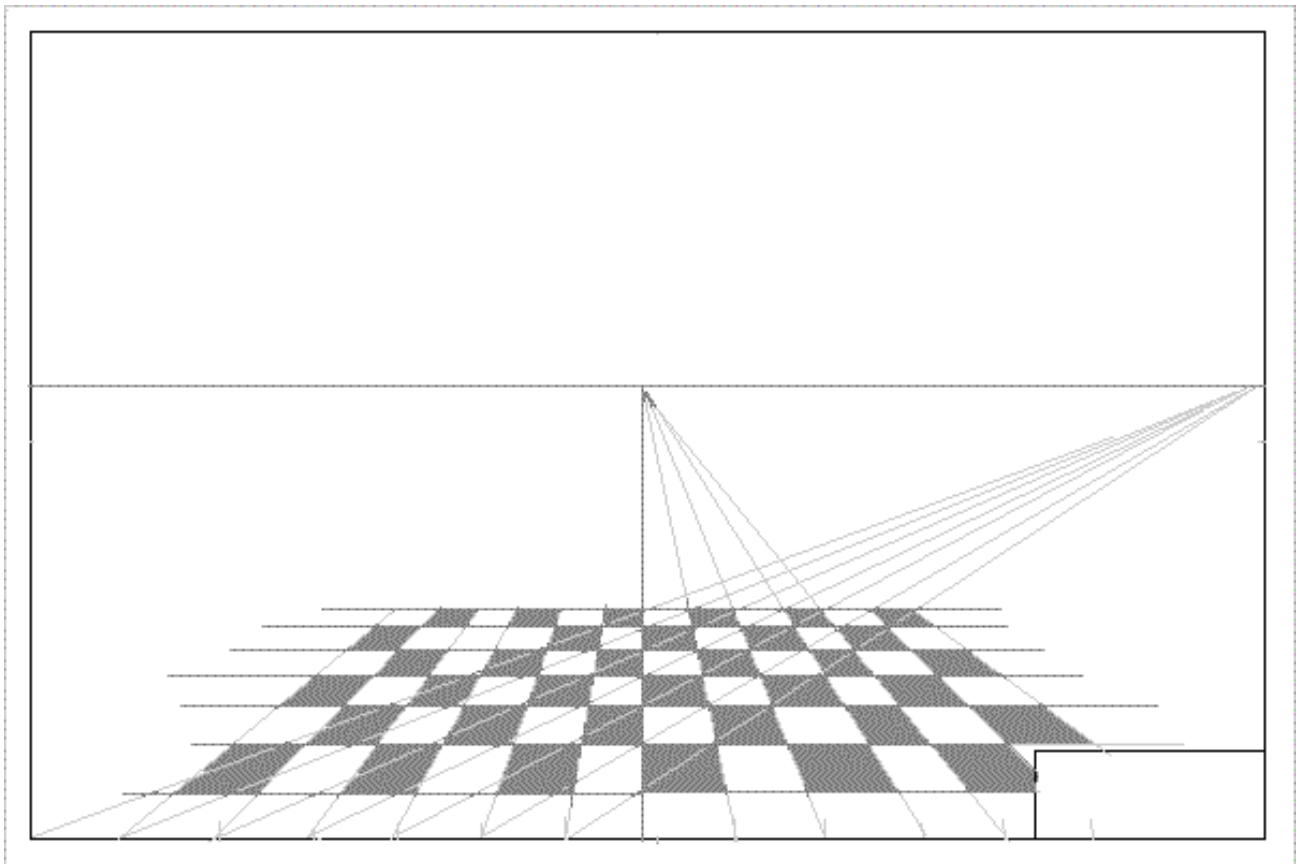

e) Shade alternate tiles.

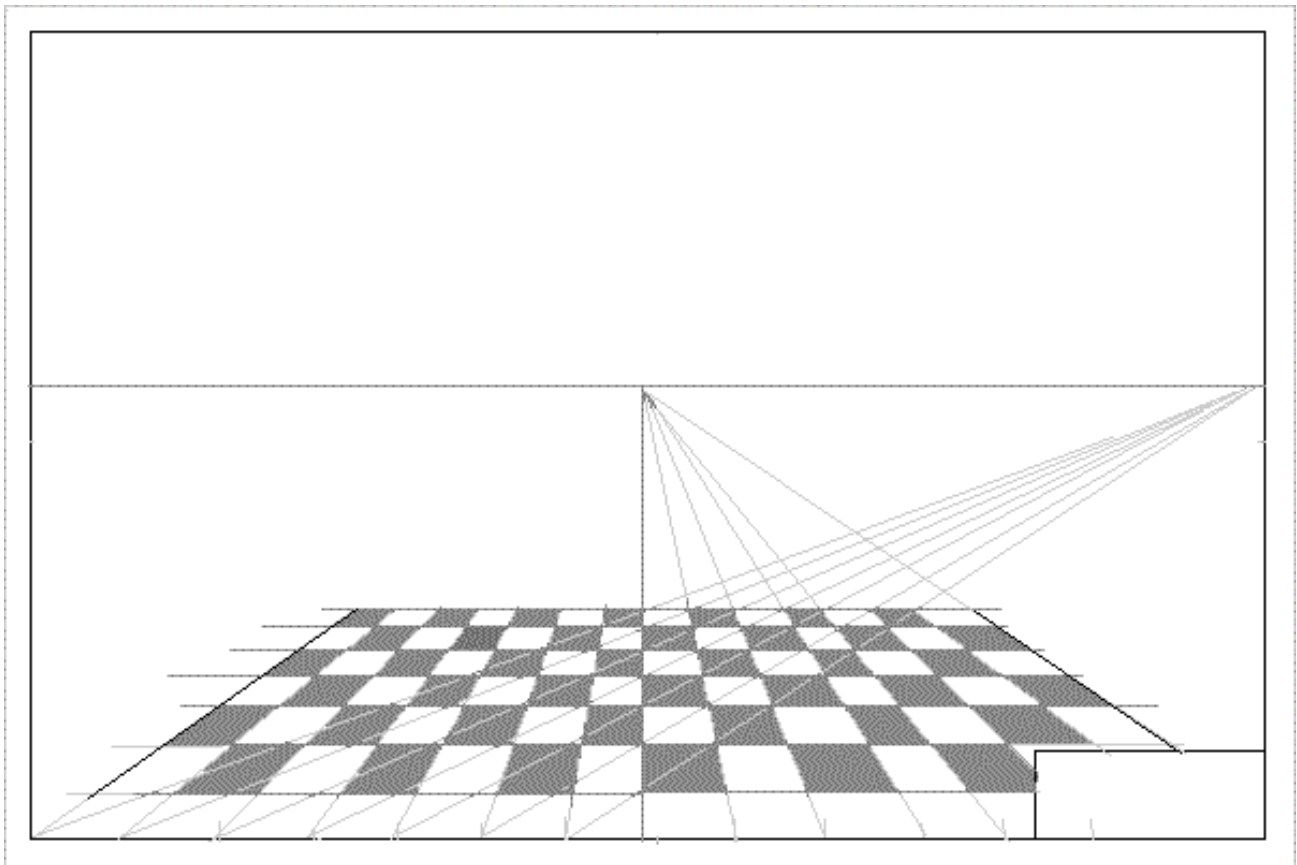

f) Add two more rows to the outside.

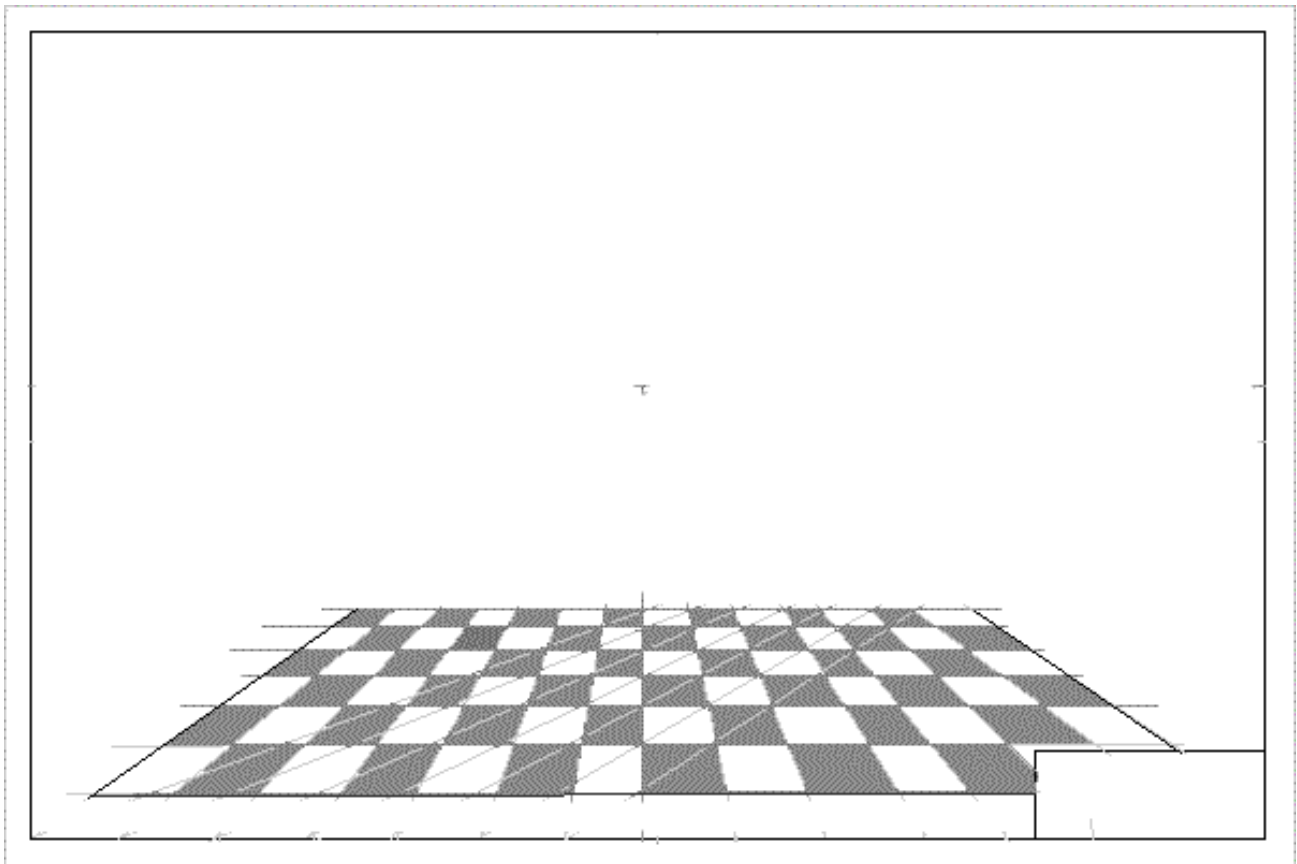

g) Clean up with eraser if necessary.

Revise ask:

What does RVP stand for?

What is the horizon?

How is it we can make a drawing with depth on a flat surface?

EXPLAIN :

The 'flat' surface is like a window or a sheet of glass. It is called a 'picture plane' (PP). The 'observer', the person looking is standing a distance behind the PP and the floor is a particular distance in front of the PP.

At this point we need to interrupt our drawing to learn to draw circles. Since we have no tools to trace or guide us we will need to learn to draw these - freehand. We need to know this to complete our current project. So start a new sheet and ...



[GO TO ... LESSON SIX 'B'](#)

[lesson menu](#)

For those folk who have enquired a **CD version** of these 'painting' as well as 'drawing lessons' and 'advanced painting' lessons will soon, I hope, be available to everyone. It will be an updated, reformatted for easy printing version so you can create you own reference handbook in your own time, or just browse the CD.

It is anticipated the CD will be available at around \$15 (plus posting) for students and \$19 (plus posting) for others. The CD's will be distributed on a first come first served basis. Isn't that always the way?

To be added to the list just send me a simple [email](#) with the words 'please notify CD' and your name and status (only if a student or teacher).



LESSON - PERSPECTIVE SIX- ROOM INTERIOR (CVP)

TIME:

Allow 60-80min - this is the second part of the double lesson

Aim:

To introduce the freehand method and technique for the construction of curves and use this to complete our room interior.

Materials:

The sketch pad,
HB pencil, ruler.

Construct margin and title box on a new page then:

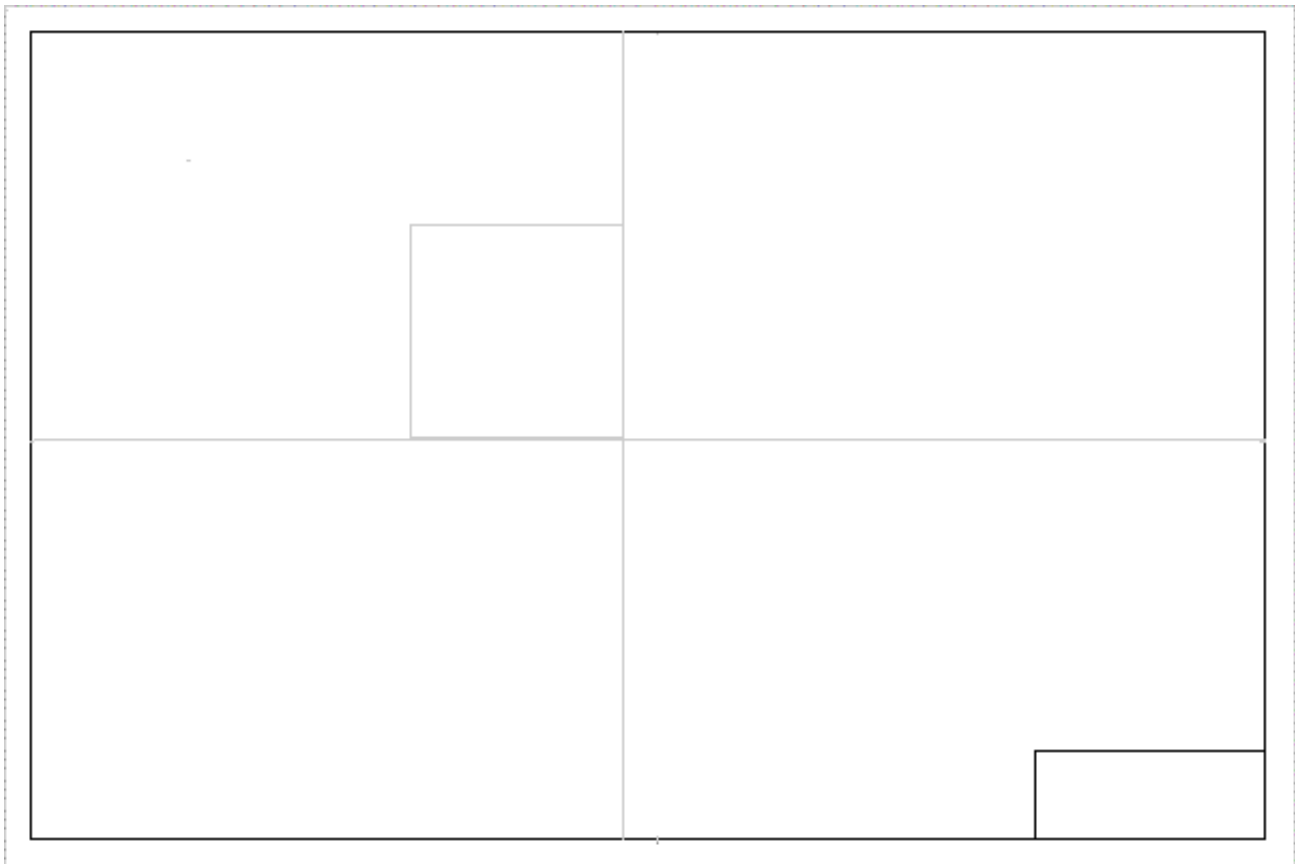

a) Construct a 75mm (3") square as shown

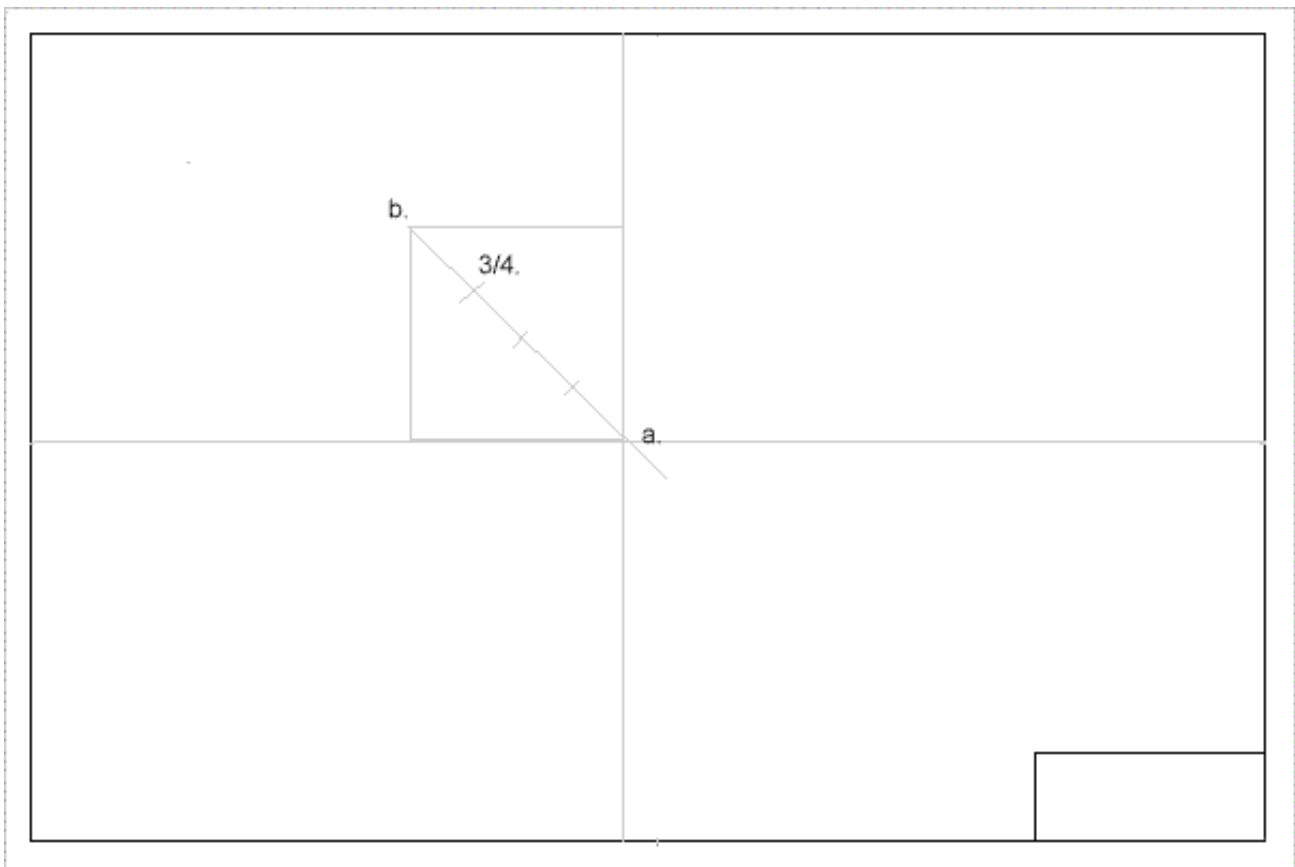

b) Draw the diagonal a-b and without measurement divide into four equal parts.

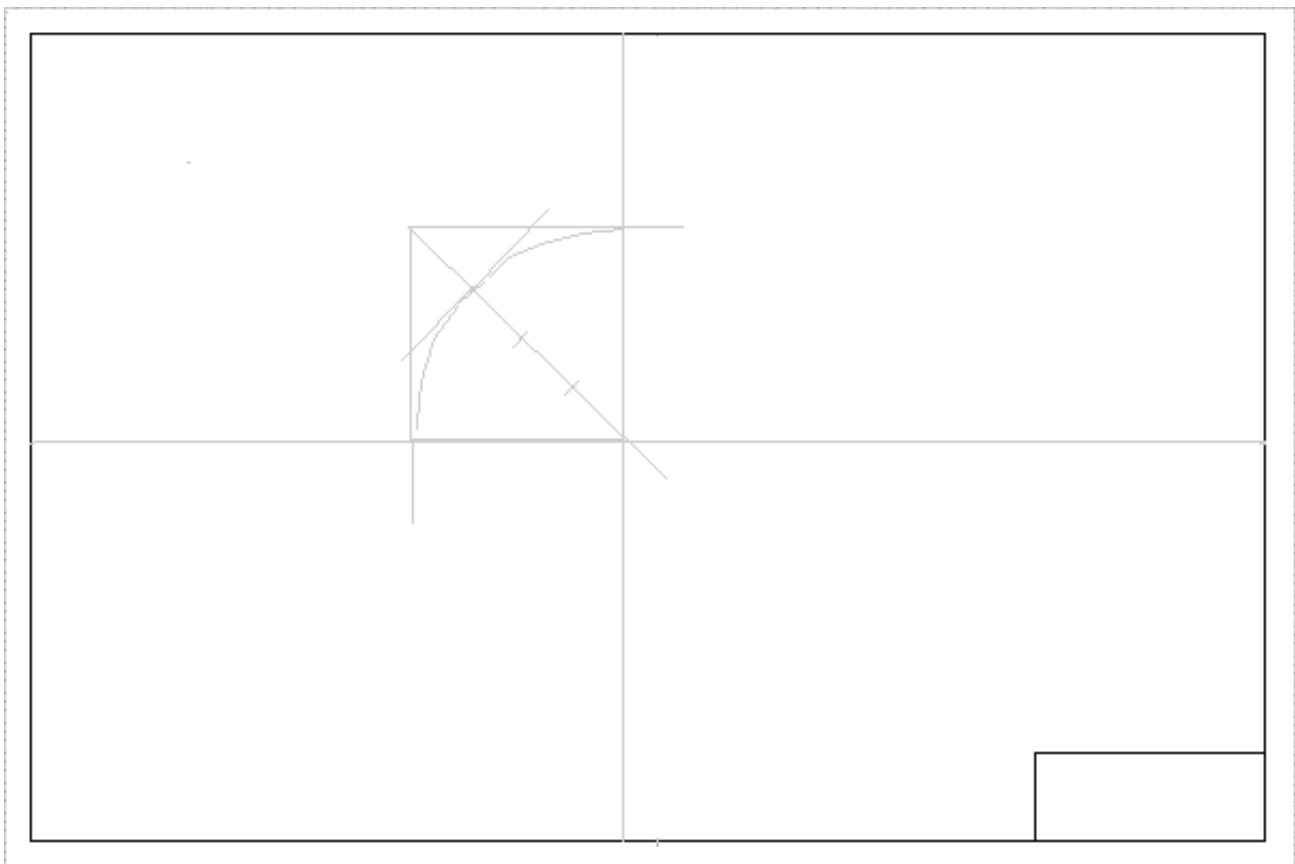

c) Draw a 45 degree tangent through the 3/4 division as shown and **lightly** sketch the freehand curve. The curve actually cuts the diagonal just below the three quarter mark and above the two thirds point. The students should be encouraged to draw the curve so it 'looks right.'

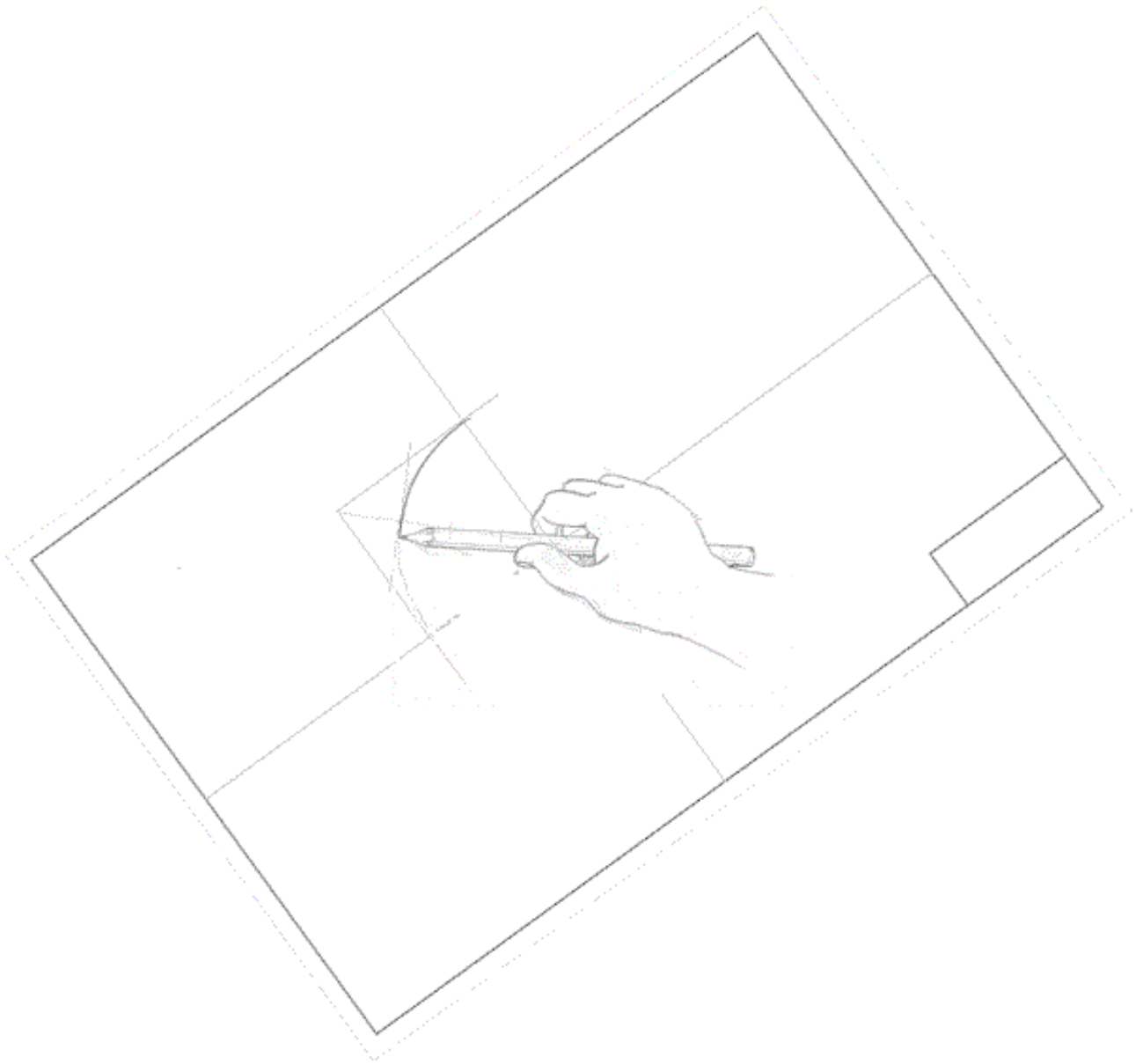

d) When drawing the curve keep the hand on the **inside** of the curve. This may necessitate keeping the hand still and moving the paper as demonstrated above.

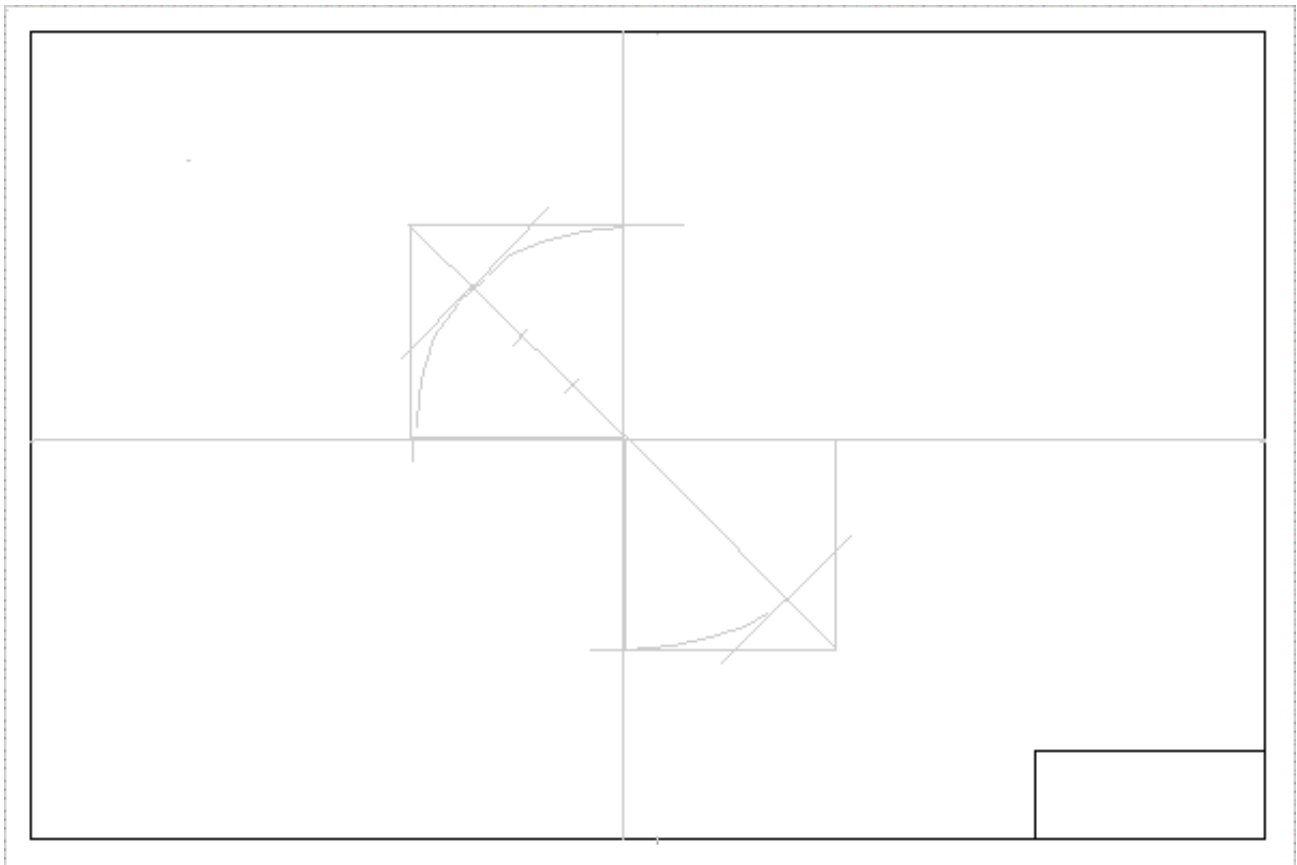

e) Construct the square as shown and turn the page upside down to sketch the opposite curve.

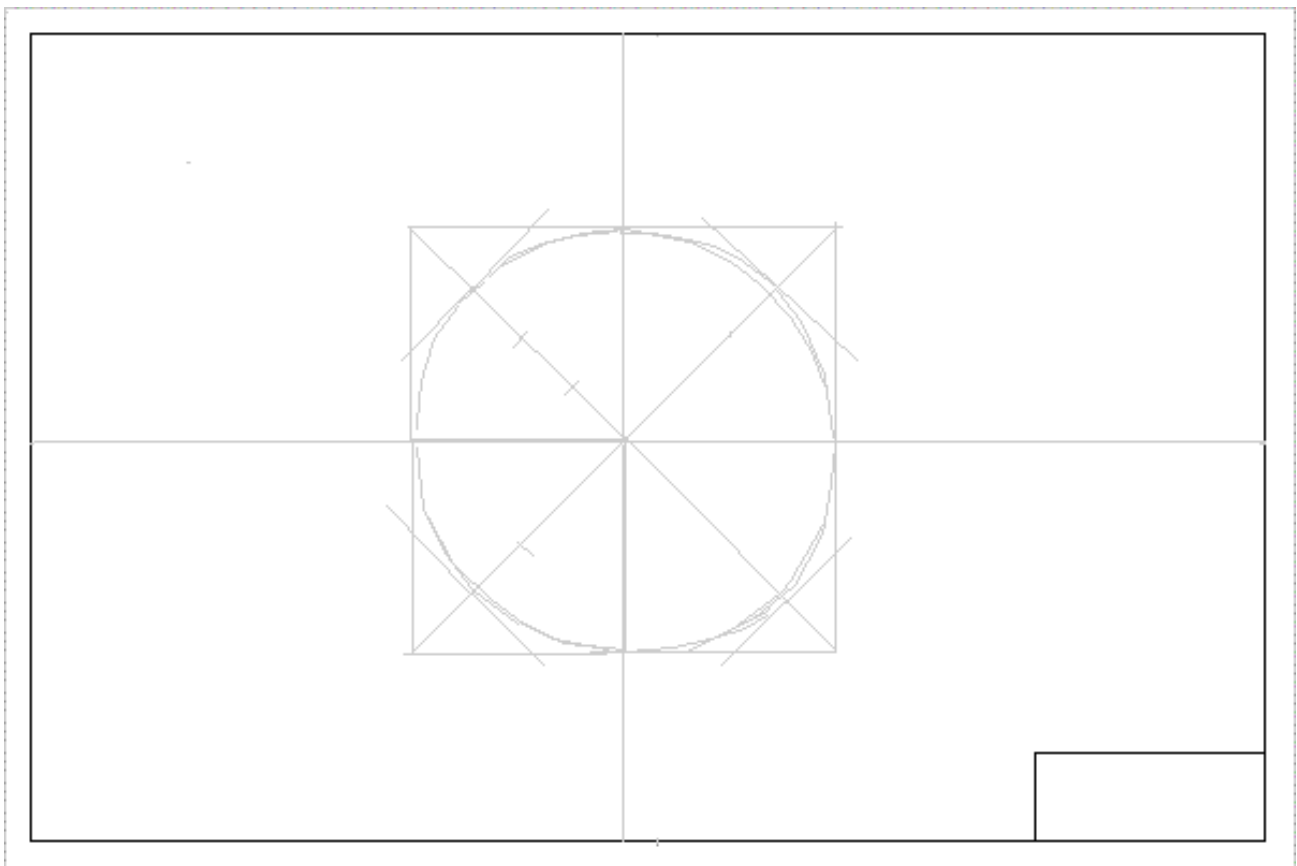

f) Complete the whole circle lightly and make adjustments where necessary.

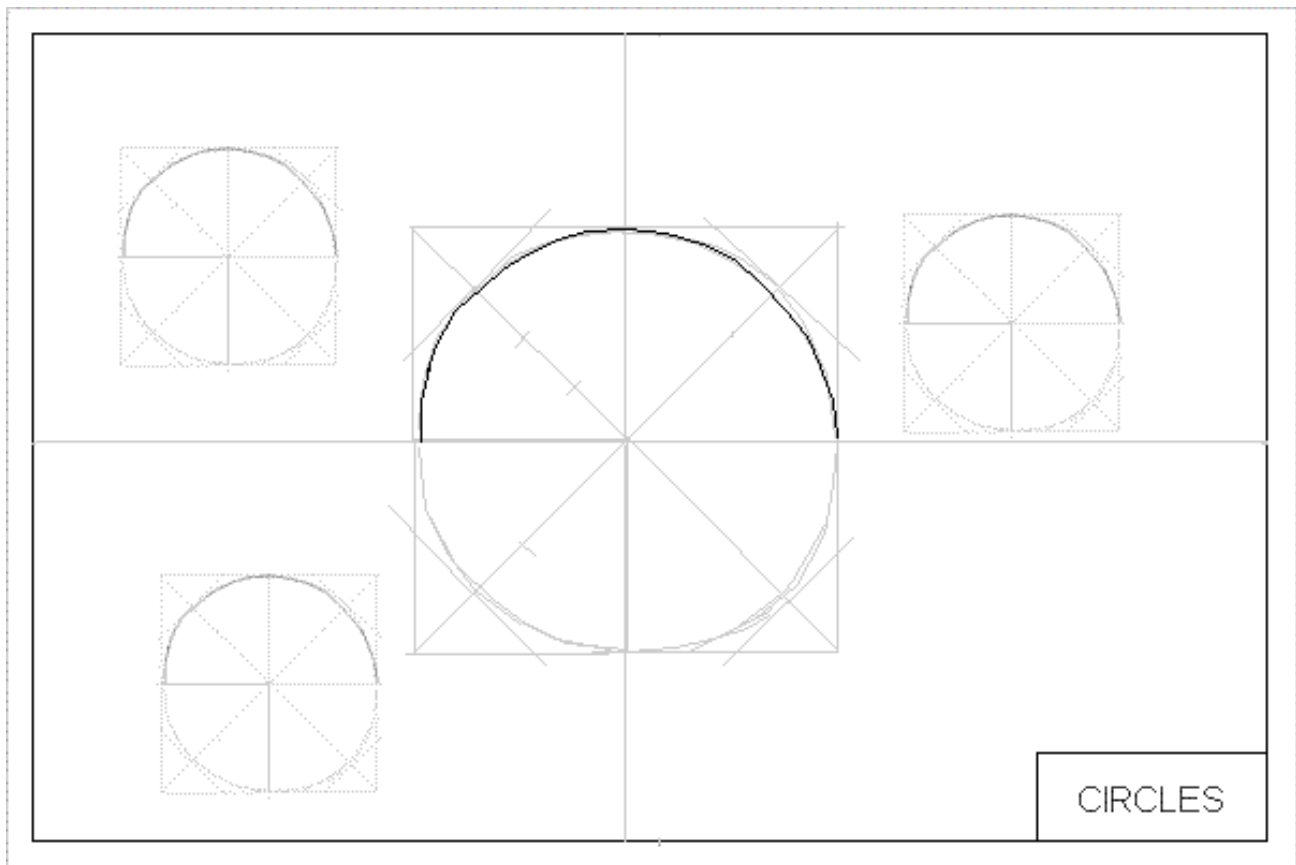

g) Practice circles of differing sizes, label and turn back to interior of room. For homework the student can practice two or three more.

[Return to previous page of room interior ...](#)

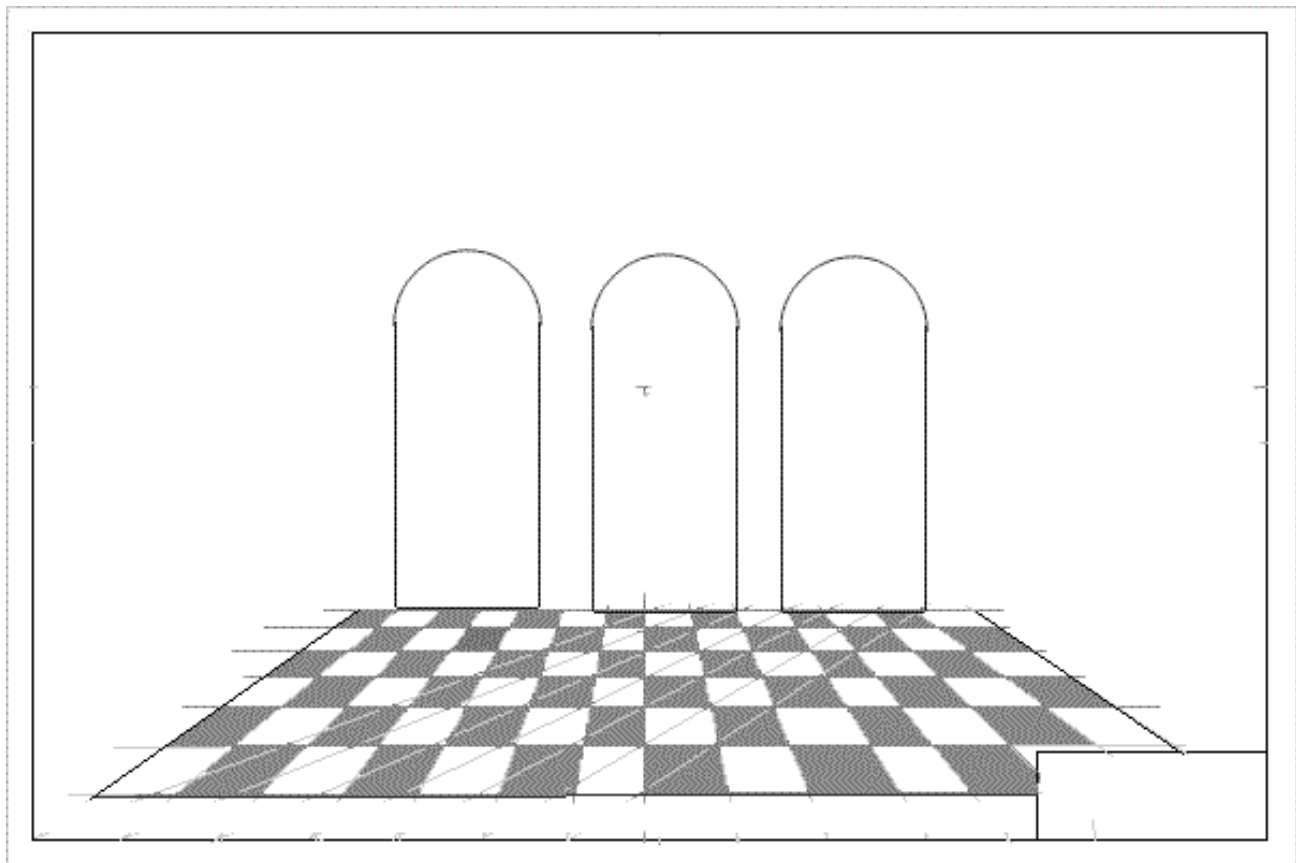

h) Using the method recently learnt construct the three arched portals and firm them in.

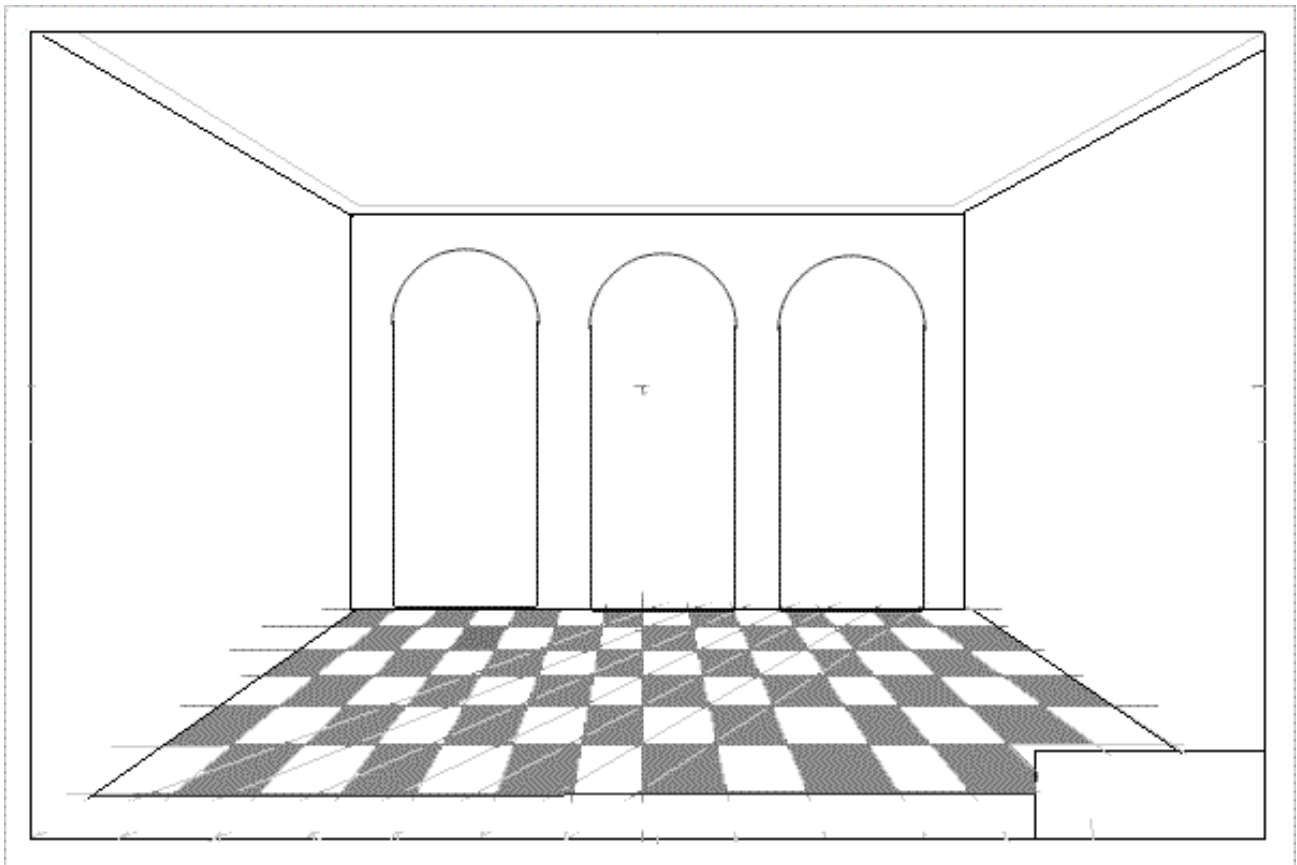

i) Draw a light rectangle around the portals to make a wall and firm in. Using light lines from the CVP draw the ceiling

Revise ask: What does PP stand for?

Home study : Find a picture or photograph from a magazine or elsewhere (it can be a seascape, landscape or whatever) where the horizon can be placed in its right position on the CVP. Cut out and paste on the drawing as shown below. If the student so desires they can draw in a little scene themselves.

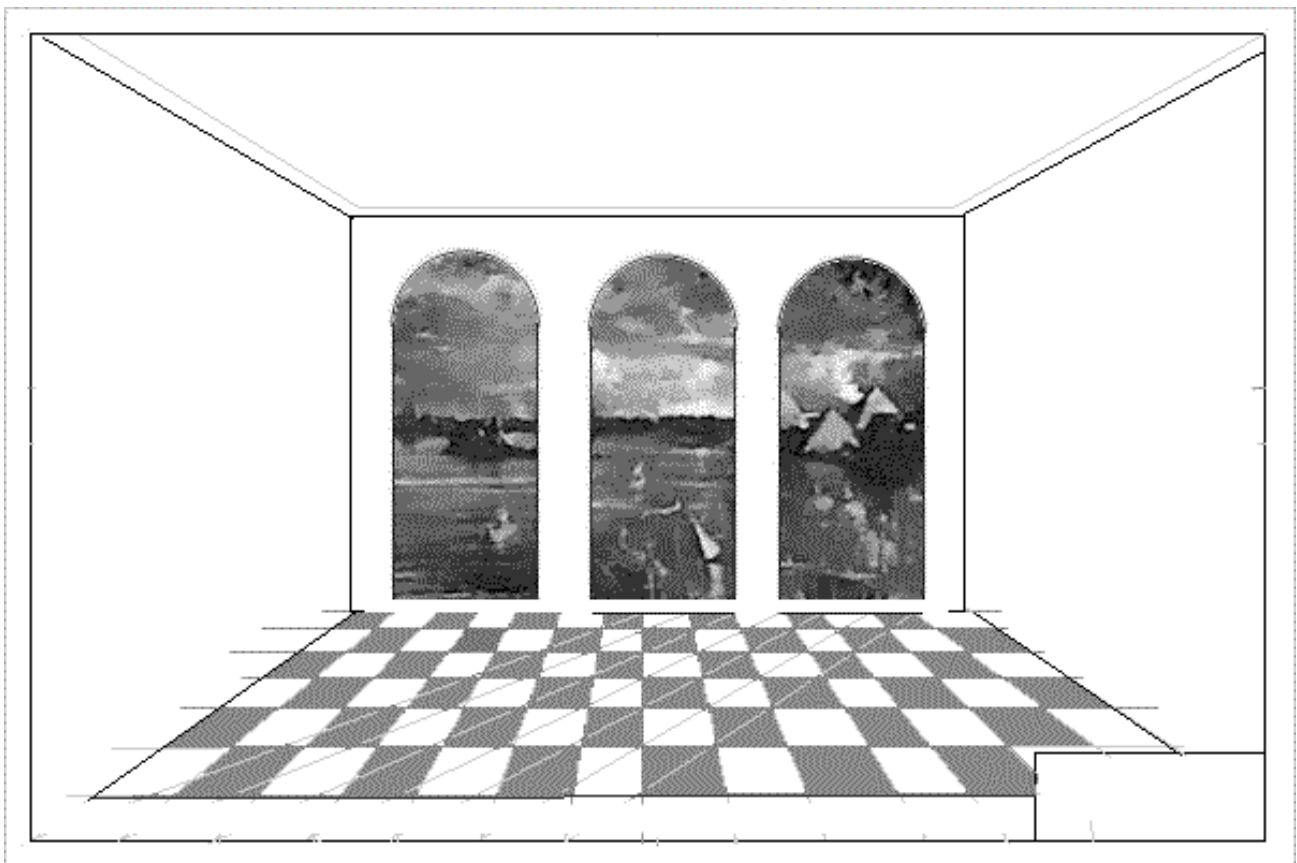

I have used part of a 'masterpiece' by a well known, if slightly erratic and unreliable, individual.

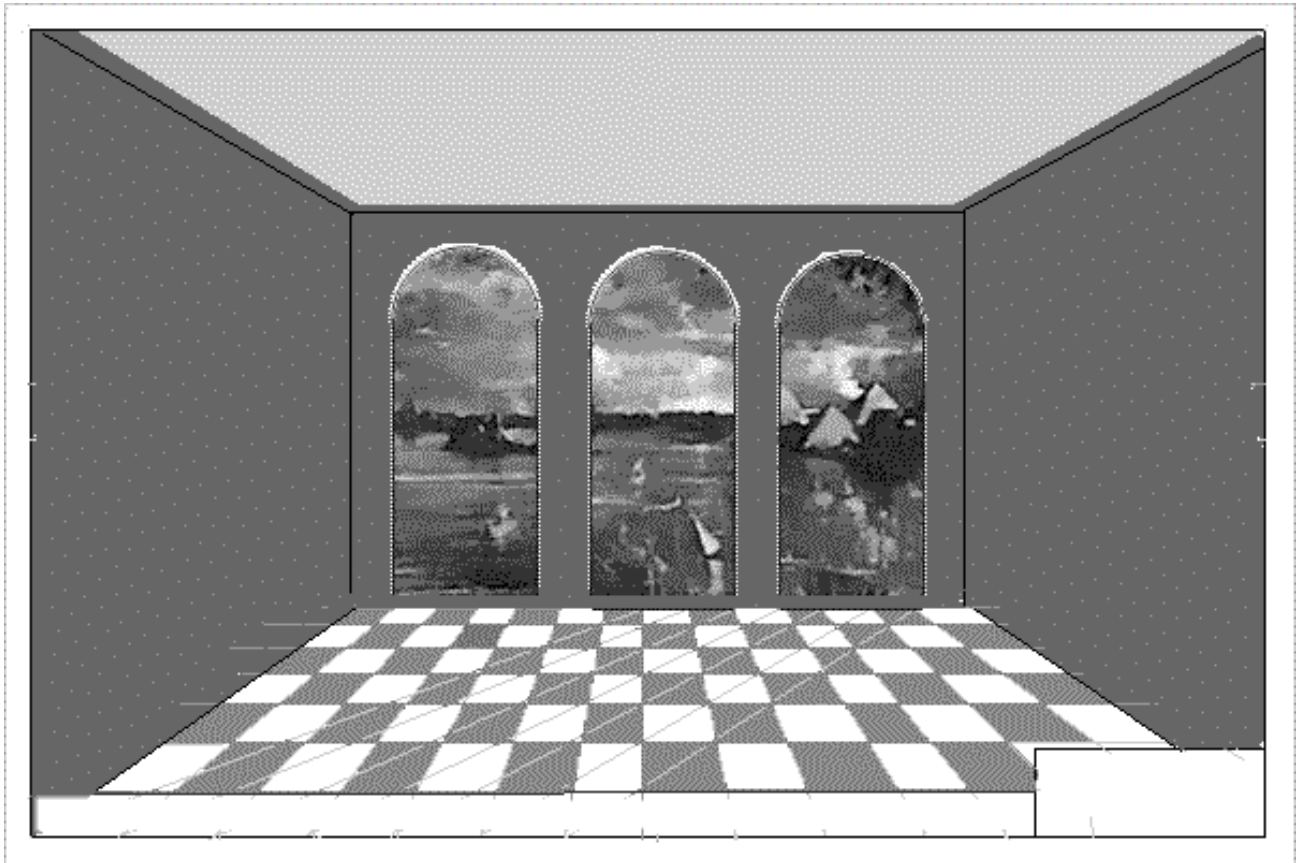

Finally the students can shade the walls, add a painting or two, a side door, etc. The teacher will find it is useful to balance the discipline of the method with the freedom to work within. Press [here](#) to see a room interior using the same method of construction by Michelangelo.



[GO TO ... LESSON SEVEN](#)

[lesson menu](#)



LESSON - PERSPECTIVE SEVEN - LETTERS

TIME: Allow 40 min

Aim: To introduce the freehand method and technique for the construction of curves and use this to complete a drawing. To introduce the notion that drawing and estimating proportion require judgements that need to be recognized, trusted and developed.

Materials: The sketch pad, HB pencil, ruler.

To Begin: (allow 10 min) (Preparation - download the first diagram below, print and make a copy for all students) Hand them out and ask:

- Which is the longest edge in Fig 1 and why? (AD because it is closest - CA and AB recede)
- What are the circumstances that would make $CA=CB$? (if the block was centrally positioned between the LVP and RVP)
- Why is CA bigger than AB in Fig 2?
- Measure all lines in Fig 2. Are any two the same size? (Discuss what we mean by real size or apparent size?)
- Fig 3 does not look quite as 'square' as it should, why is that? (AB and CA are slightly too long making the block appear squatter than the others)

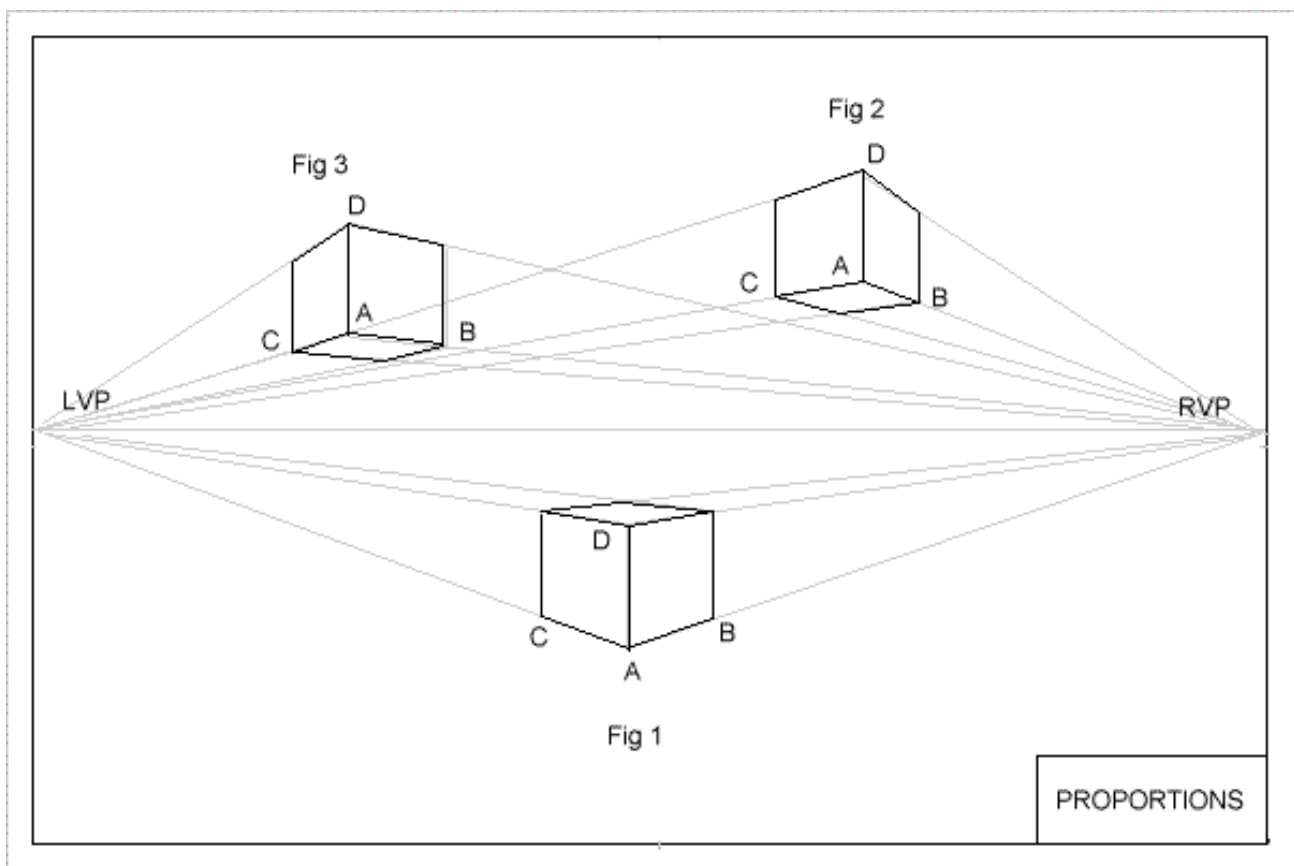

We must learn to use our eyes and judge distances and proportions. We must keep drawing them until they look right. It is the same if drawing a face or a box for always we must judge one thing in relation to all the others in the same space. The simplest object to practice and draw is the cube and we can use the cube to make many other shapes. If the cube is nearer the RVP AC will always be larger than AB while the reverse applies for the LVP.

Construct margin and title box on a new page then:

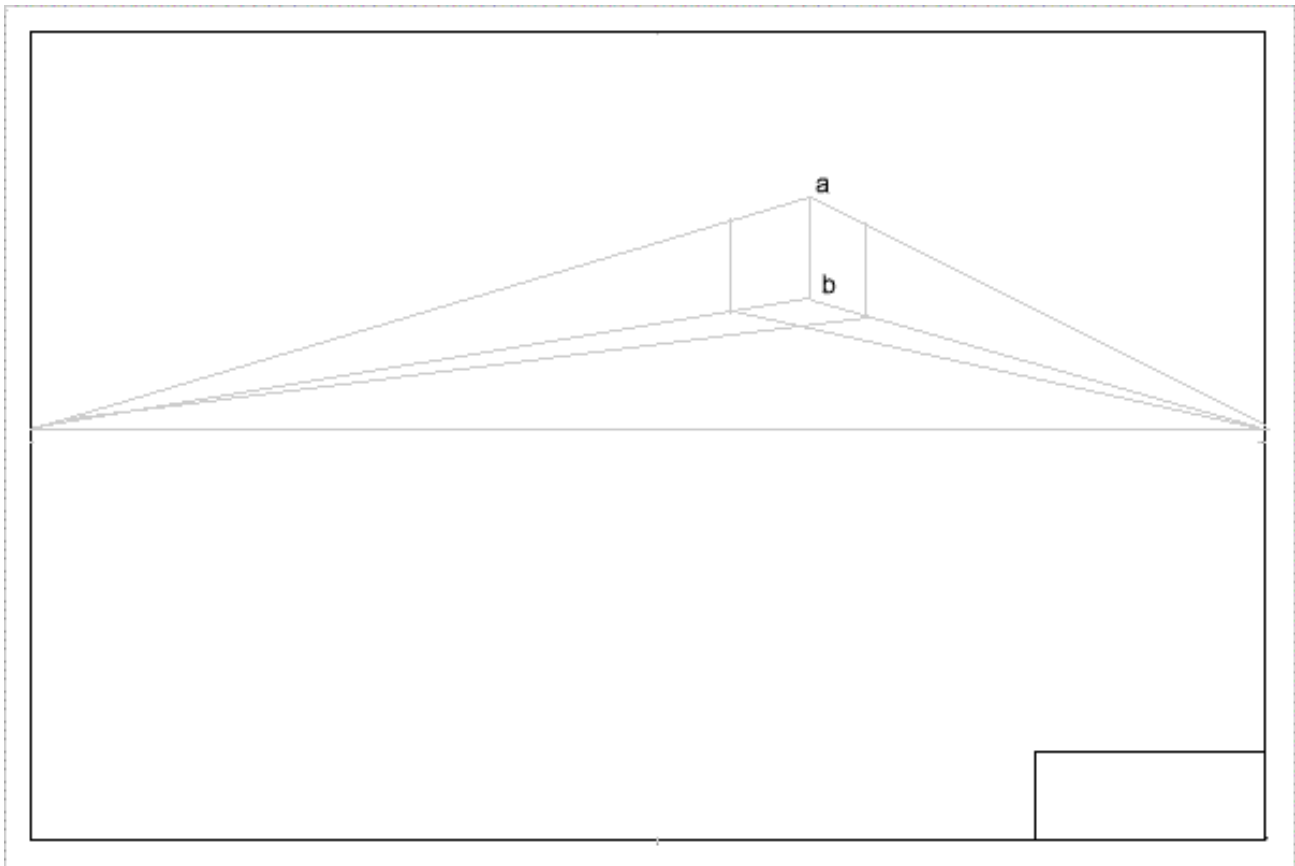

b) Draw a cube in the approximate size and position as shown above.

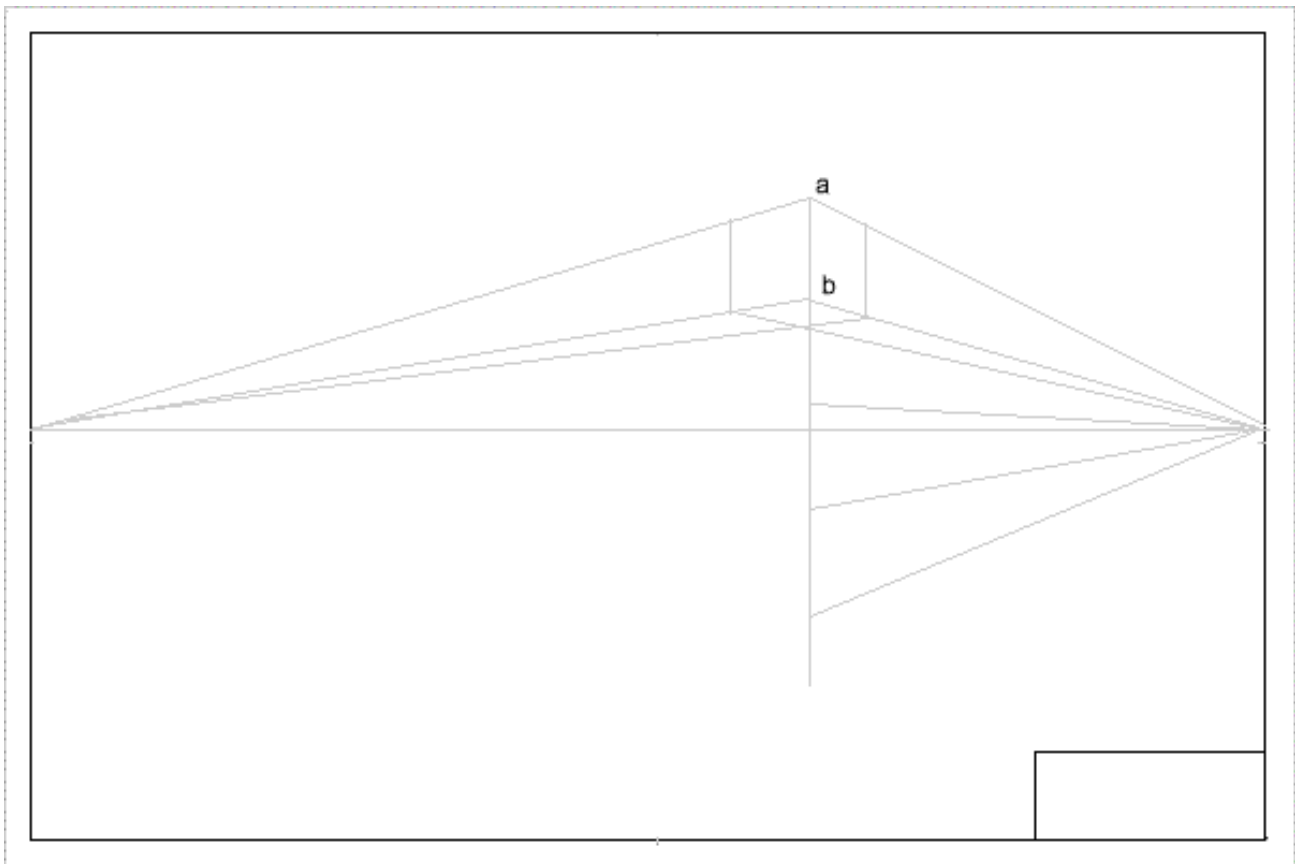

c) Extend the line 'ab' to four times its length.

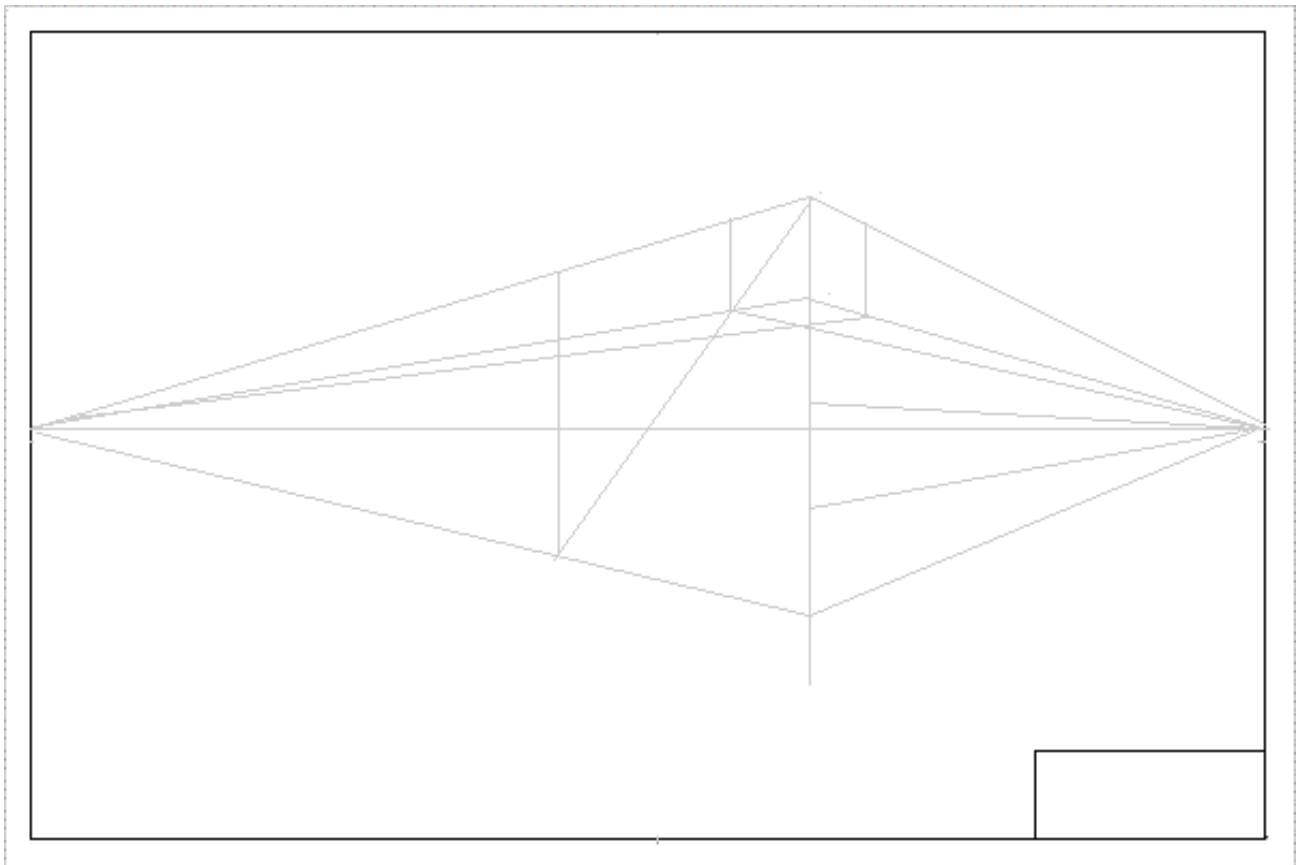

d) Draw the diagonal ... extend it, and form the square.

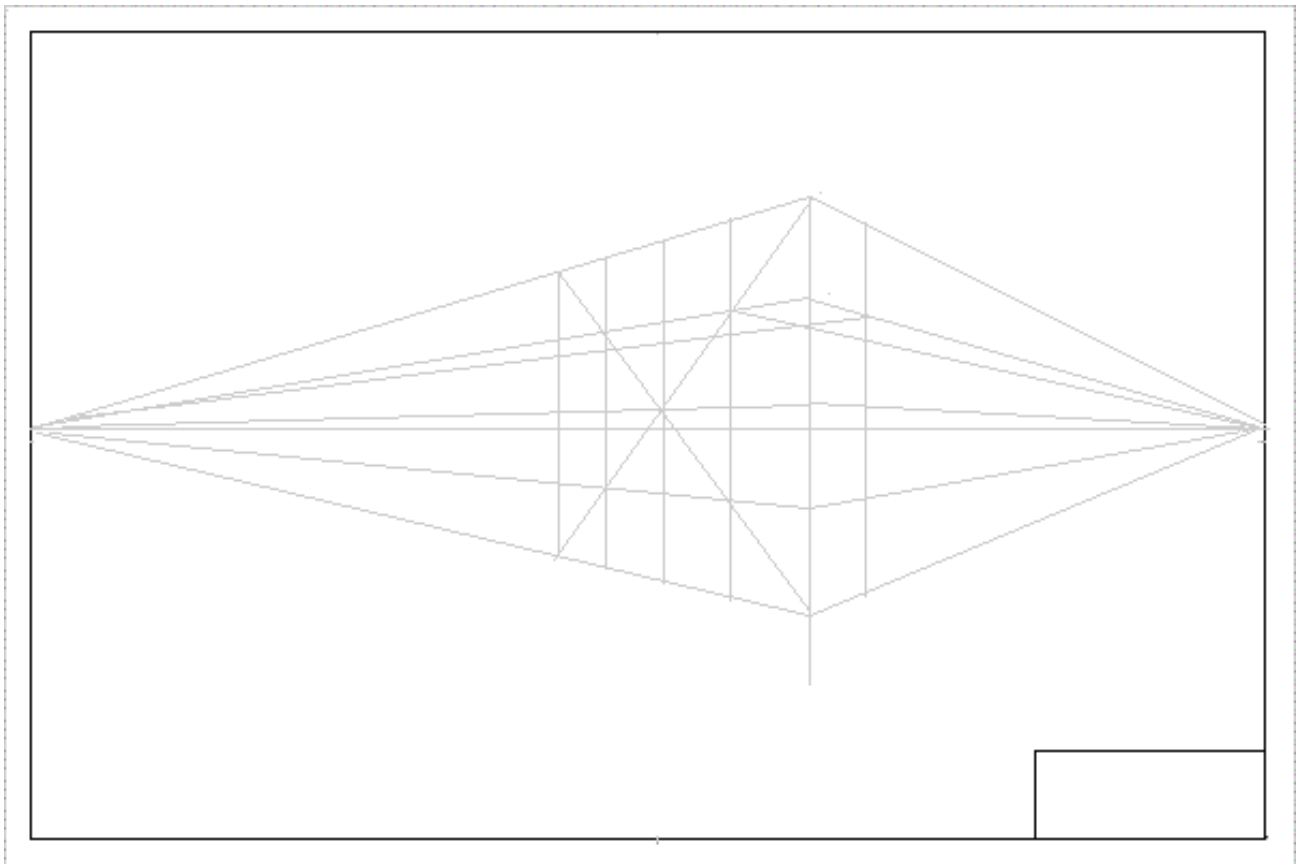

e) Construct diagonal and the 16 little boxes as shown

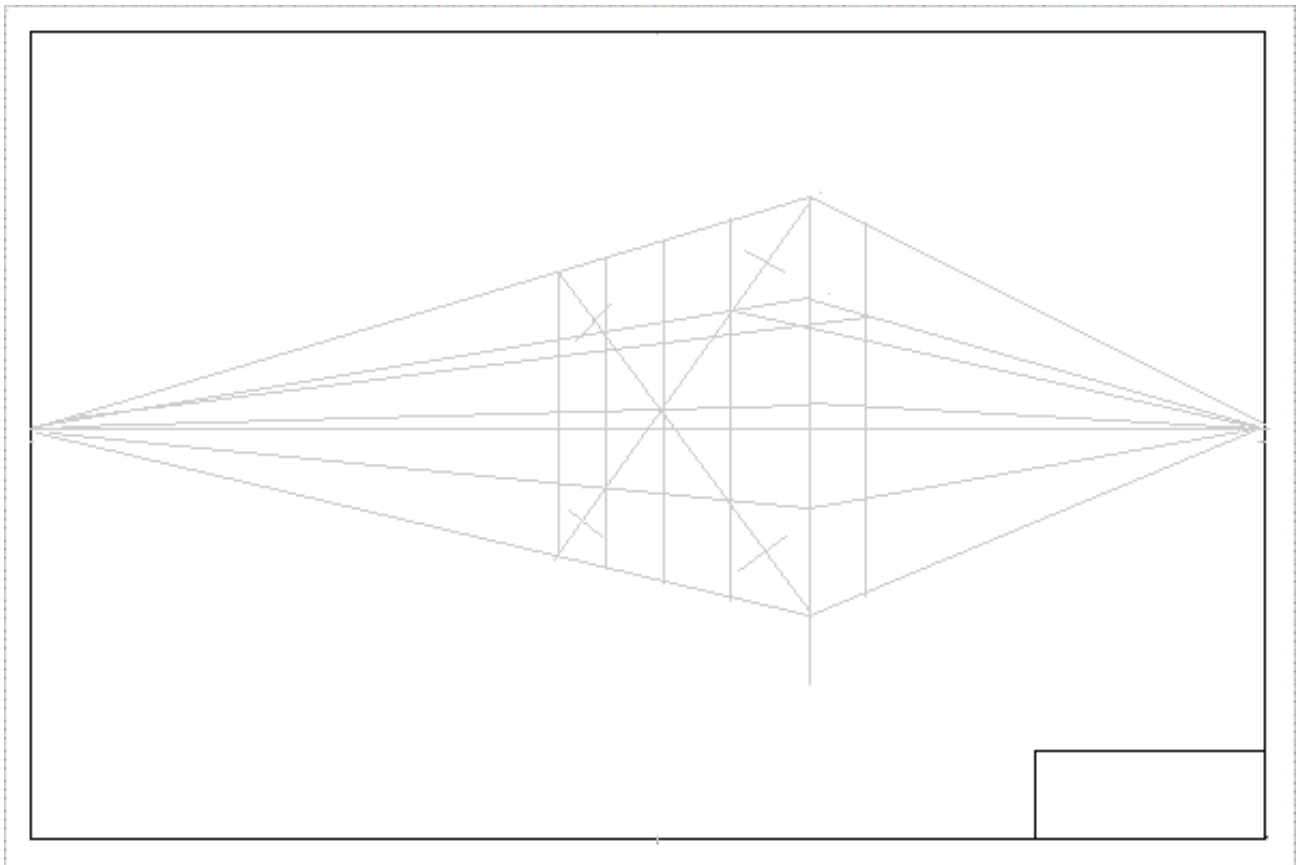

f) Mark approximately 3/4 lengths along the diagonals

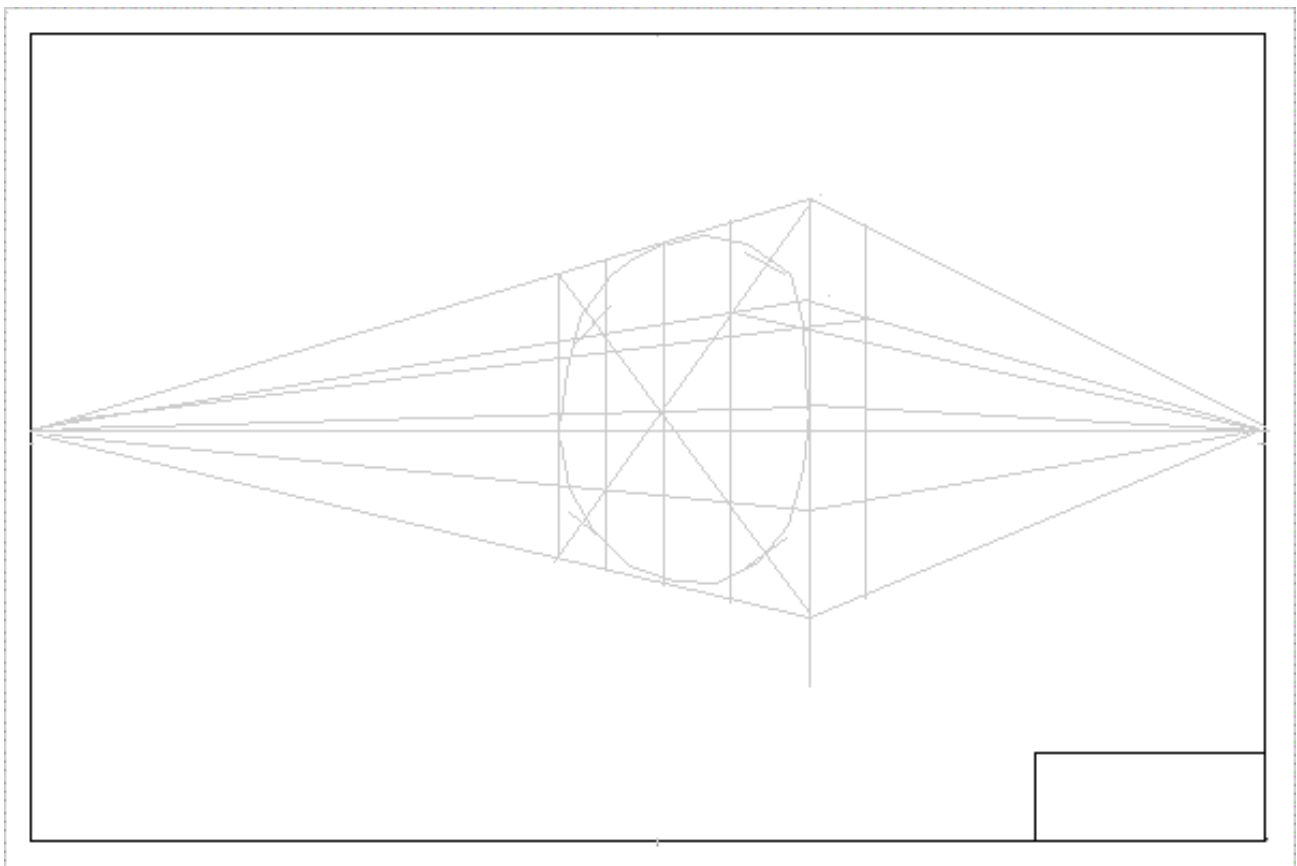

g) Lightly draw in your circle.

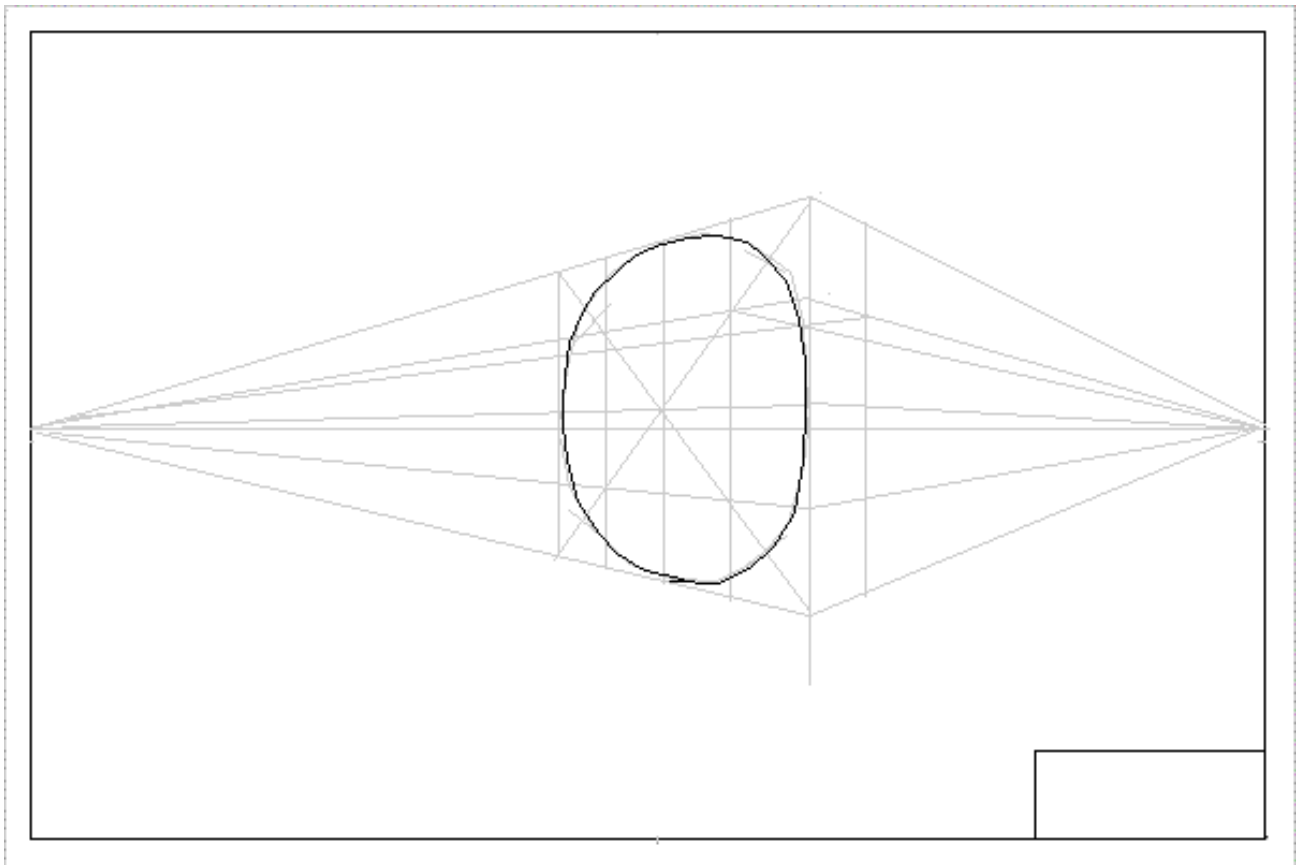

h) Firm it in.

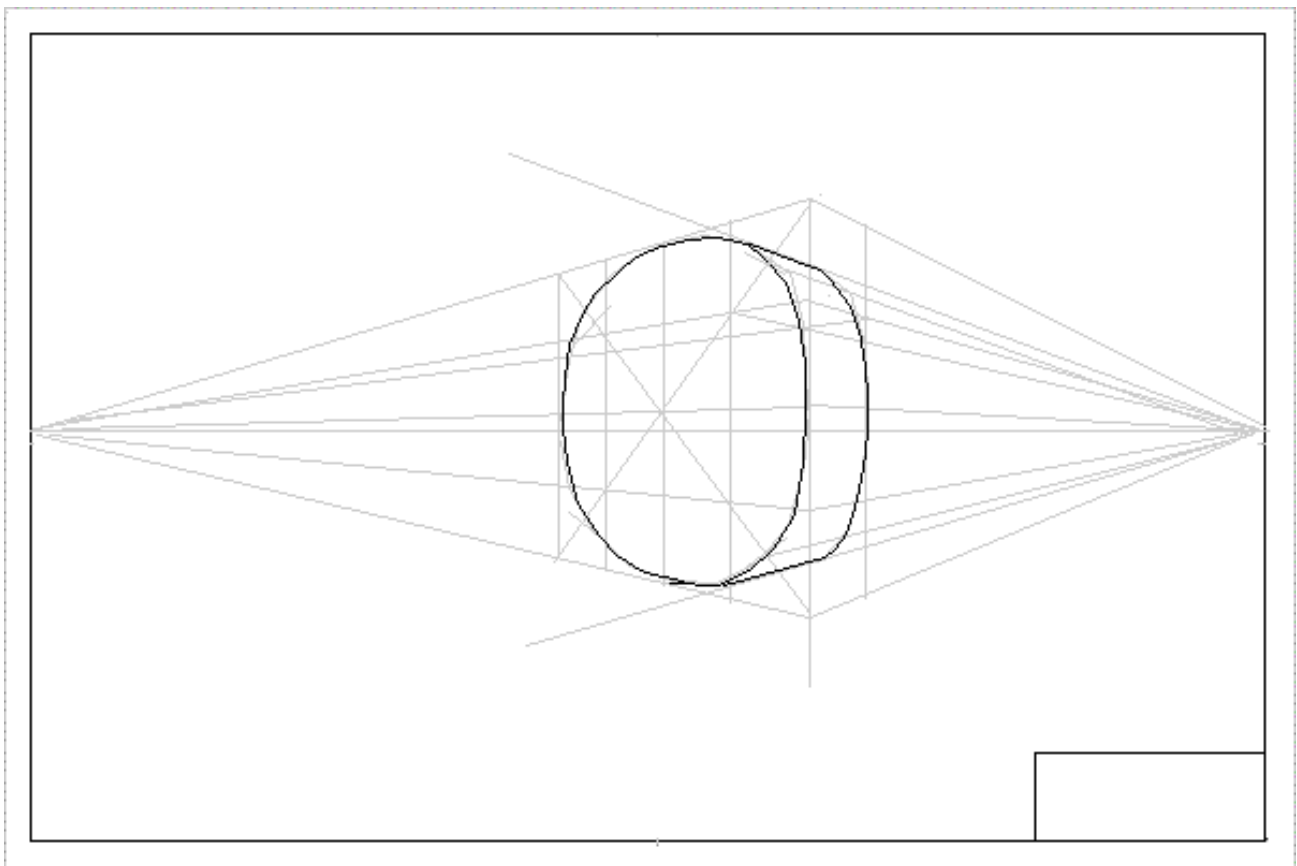

i) Give the disc thickness as shown. The lines to the RVP form 'tangents' to the circle. Sketch in lightly until it looks right then firm it in. The teacher should check ...

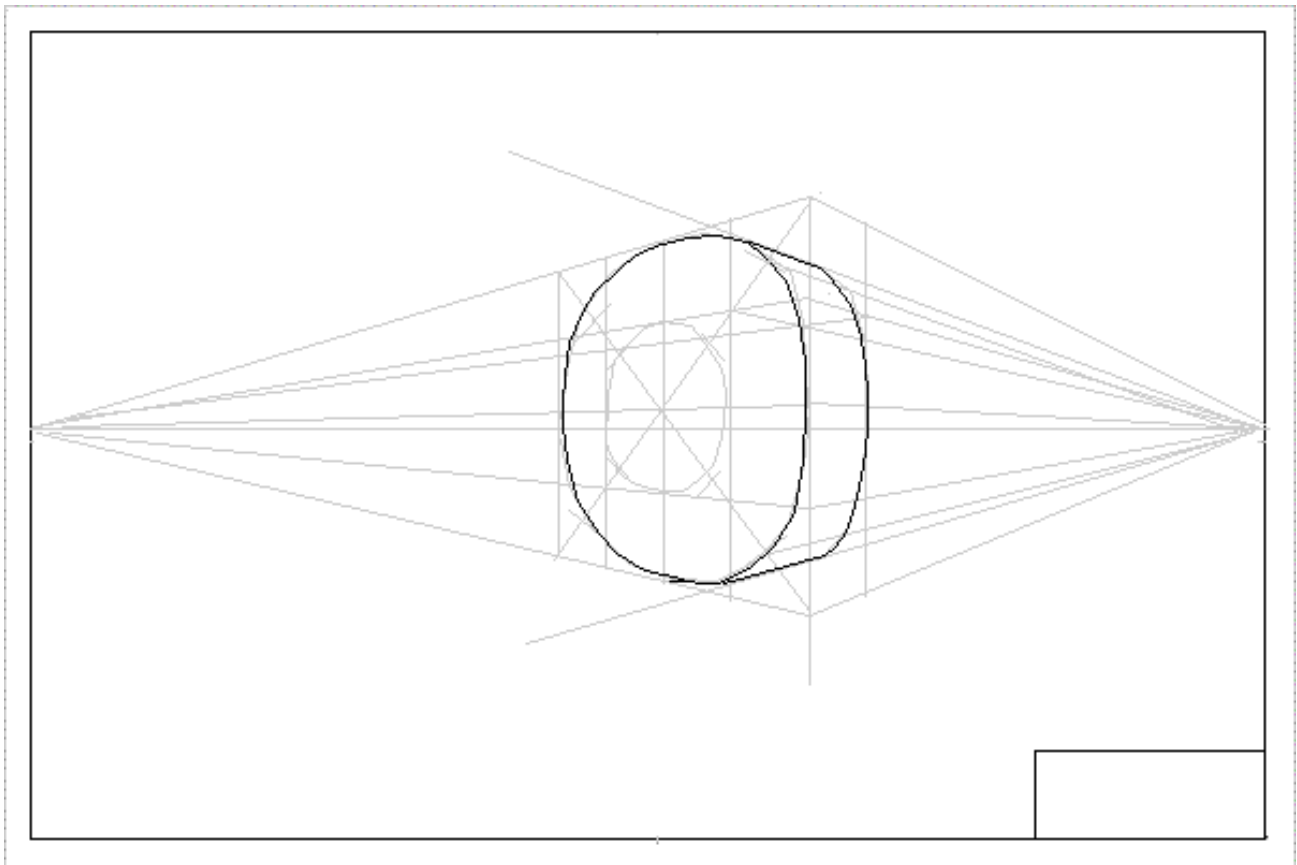

j) In the inner four squares draw another circle.

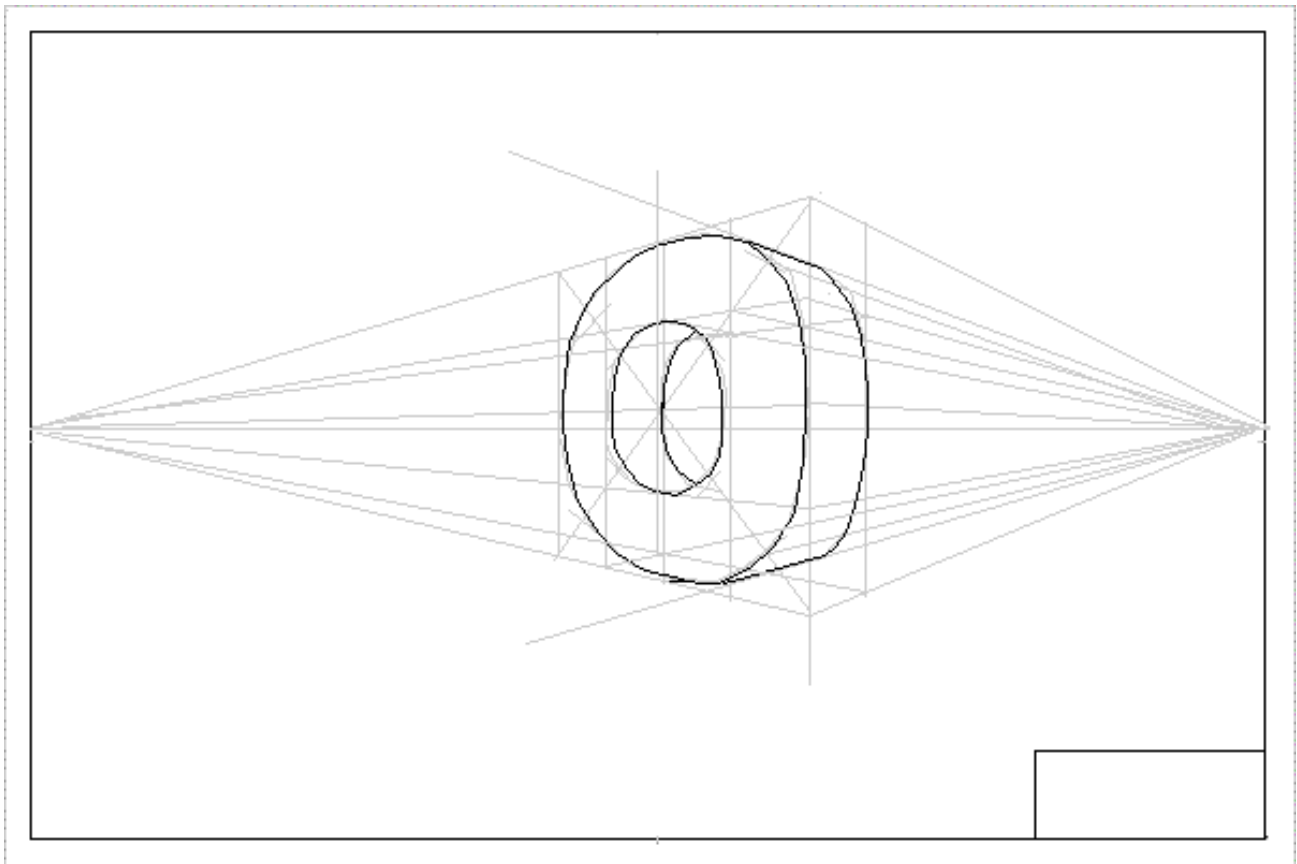

k) Firm it in and complete as shown above.

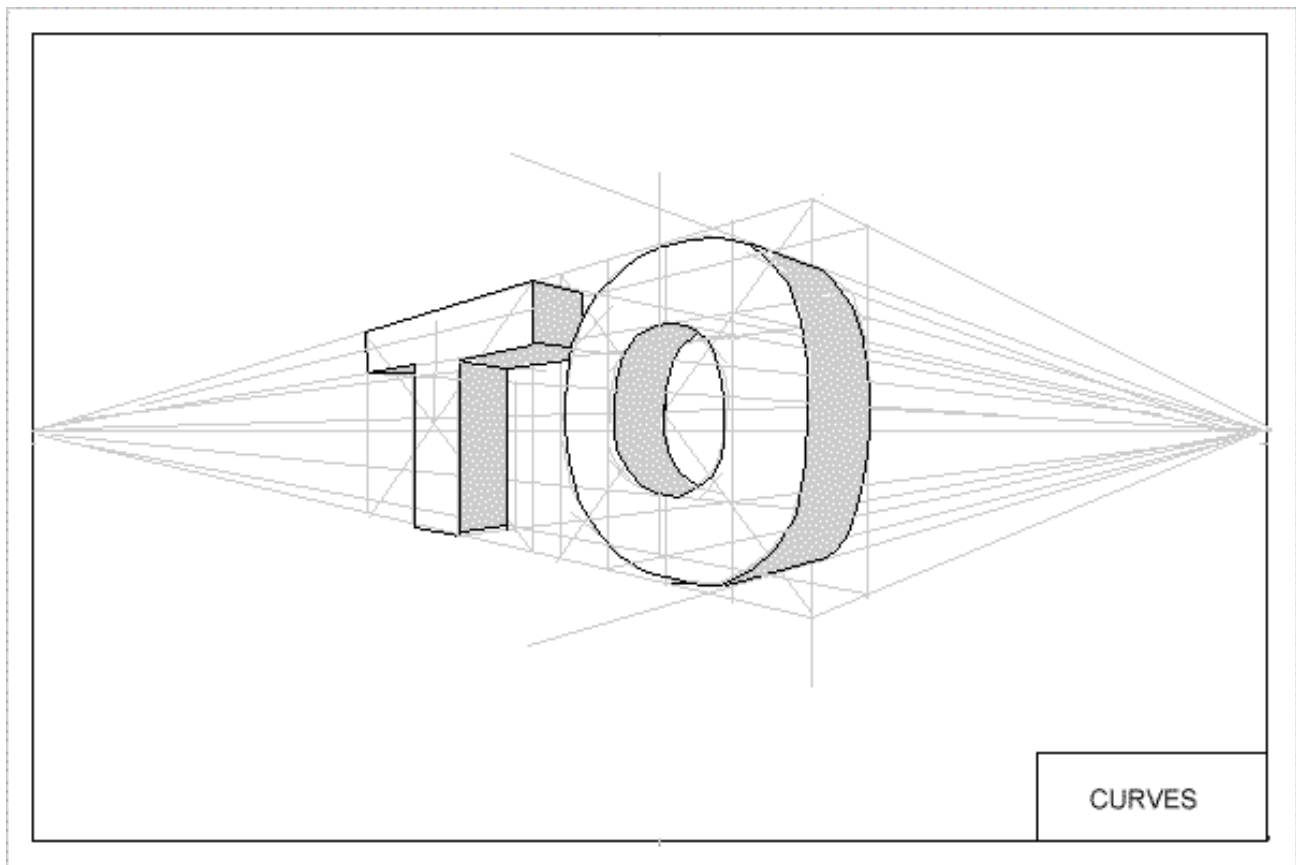

Home study :

Shade the drawing and add another letter. There are thousands of variations of this drawing. The student could perhaps try and draw their own initials in the other direction, or using just the CVP on the ground. The more confident can try and draw a large 'S' for instance as homework or a special project.



[GO TO ... LESSON EIGHT](#)

[lesson menu](#)



LESSON - PERSPECTIVE EIGHT - BASIC SHADOWS

TIME:

Allow 40 min

Aim:

To learn how to plot shadows

Materials:

The sketch pad,
HB pencil, ruler.

To To begin revise: We must learn to use our eyes and judge distances and proportions and keep drawing them until they look right. It is the same if we are drawing a face or a box, we must judge one thing in relation to all the others in the same space.

Construct margin and title box on a new page then:

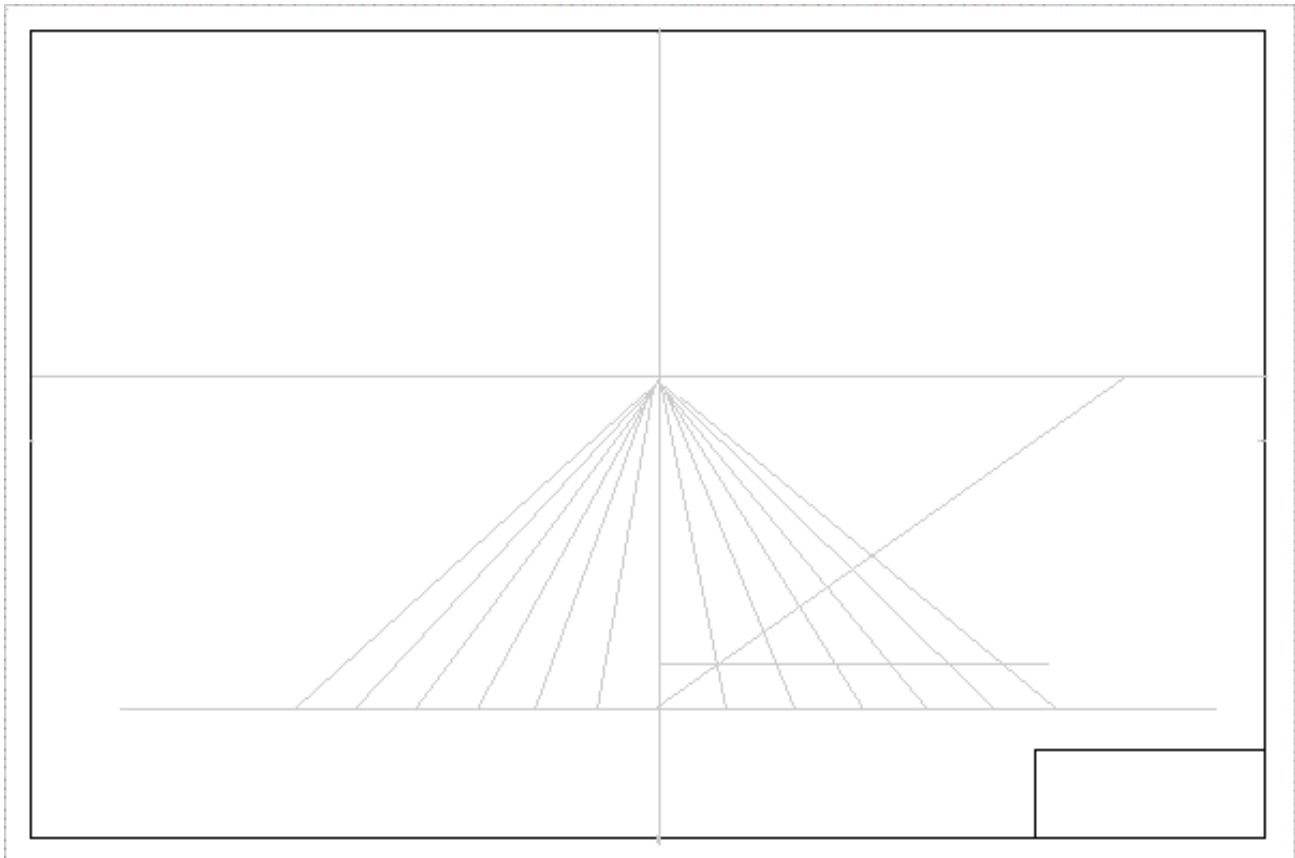

b) As in lesson six construct the grid as shown but start from slightly above the title box.

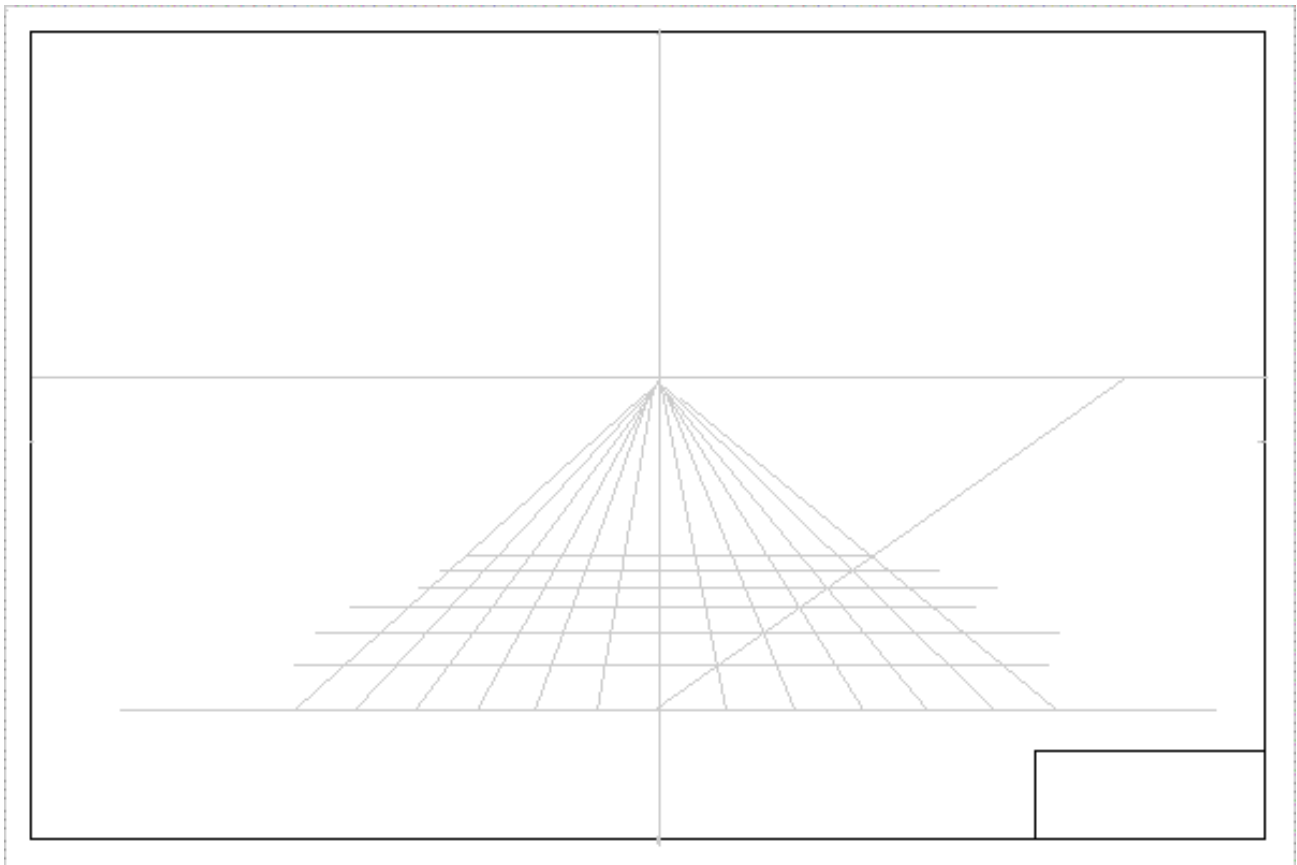

c) Note the RVP is moved slightly toward the center.

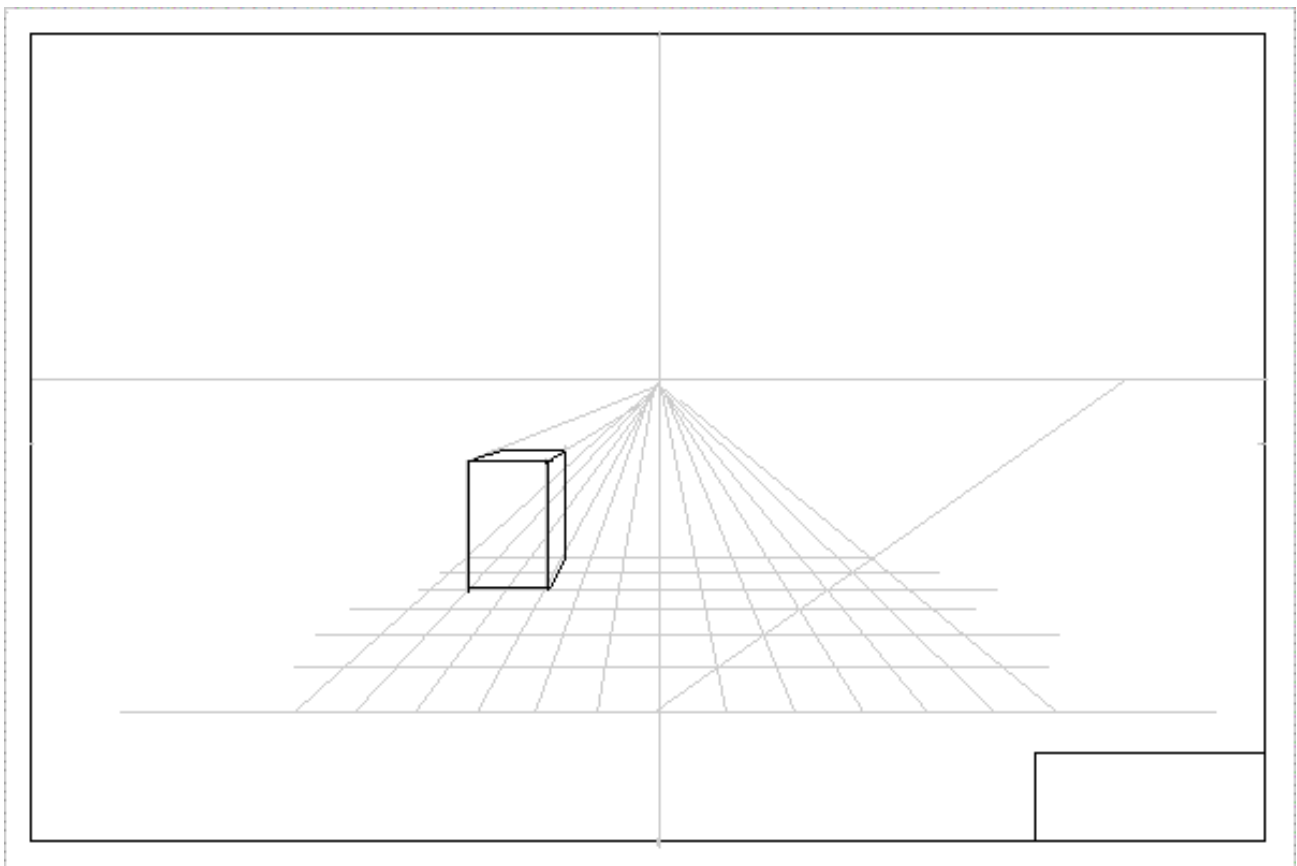

d) Draw the box in lightly then firm it in.

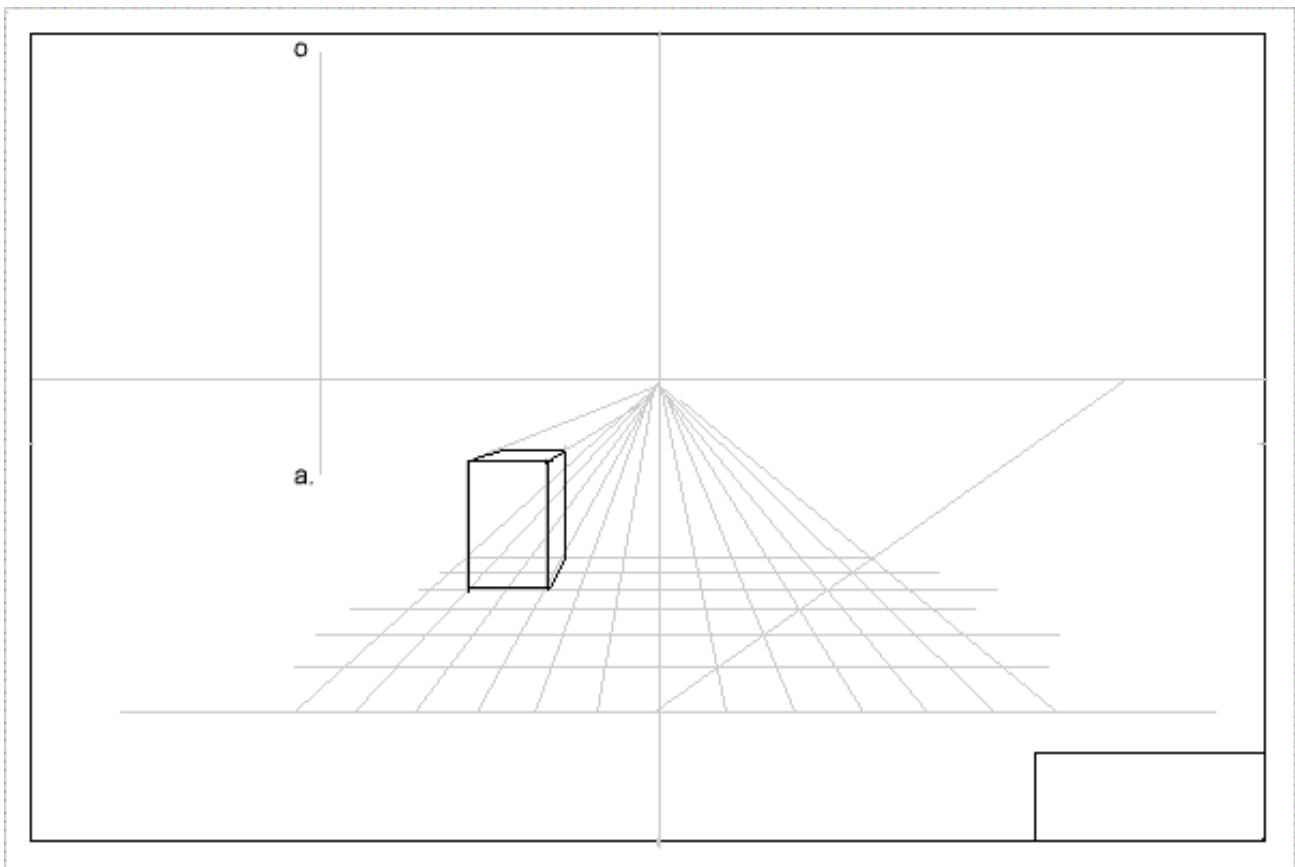

e) Draw the line approximately as shown. 'O' stands for the light source and 'a' is the spot **on the ground** directly beneath the light. You can place the point anywhere you like but I suggest you place it near where I placed mine if you want a similar shadow.

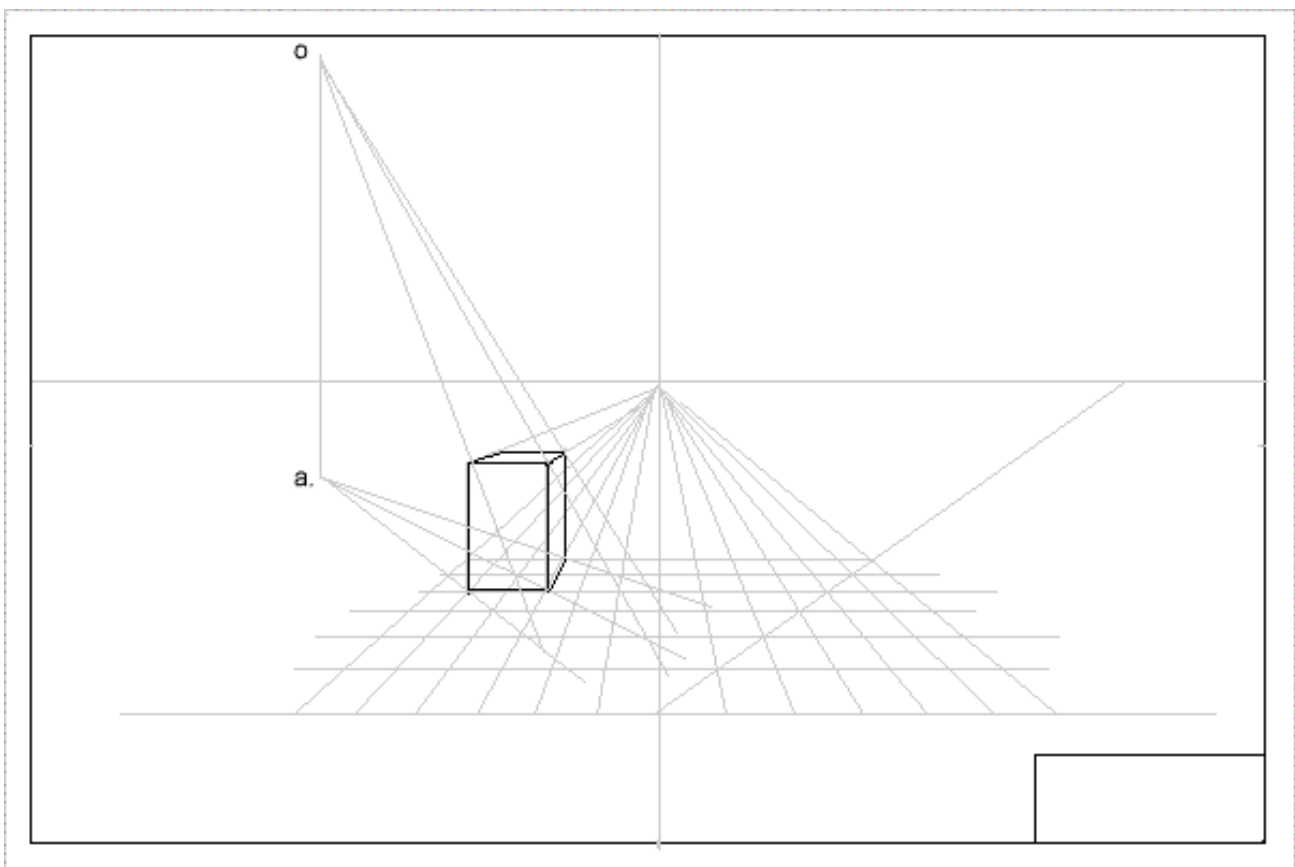

f) Draw light lines from 'O' and 'a' so they cross.

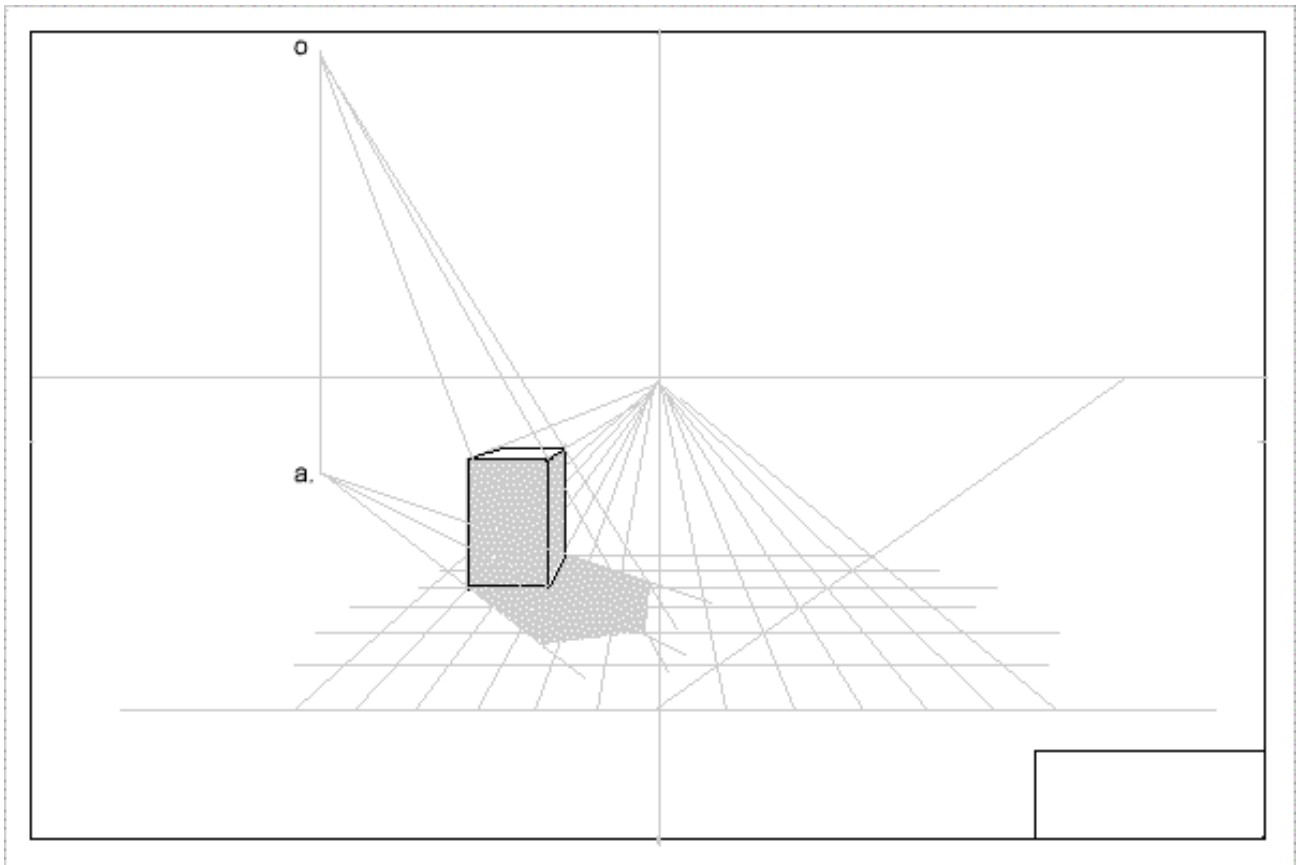

g) That gives us our shadow outline. Shade in as shown.

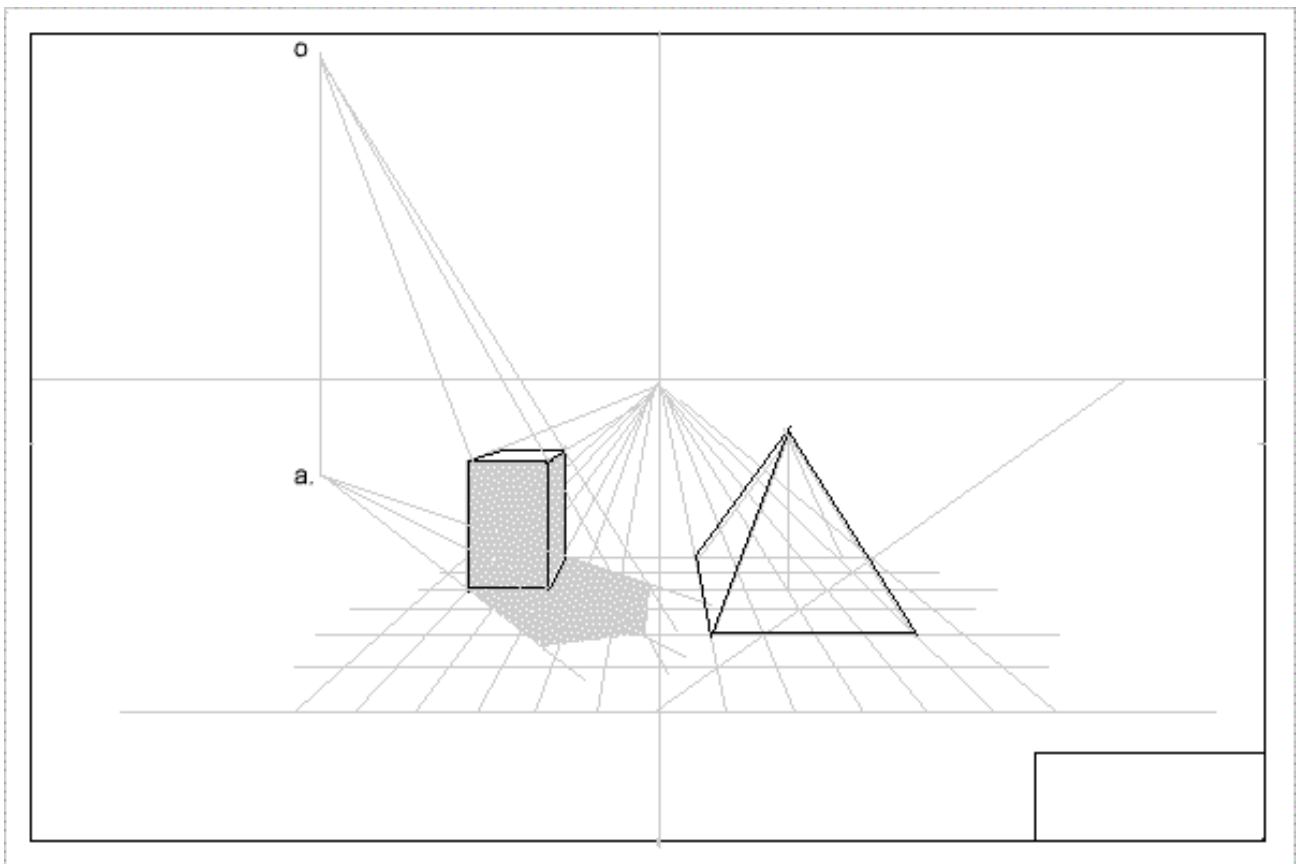

h) Using (4x4) 16 squares draw in the pyramid. The 'apex' is a point directly above the center of the base. Firm in the pyramid.

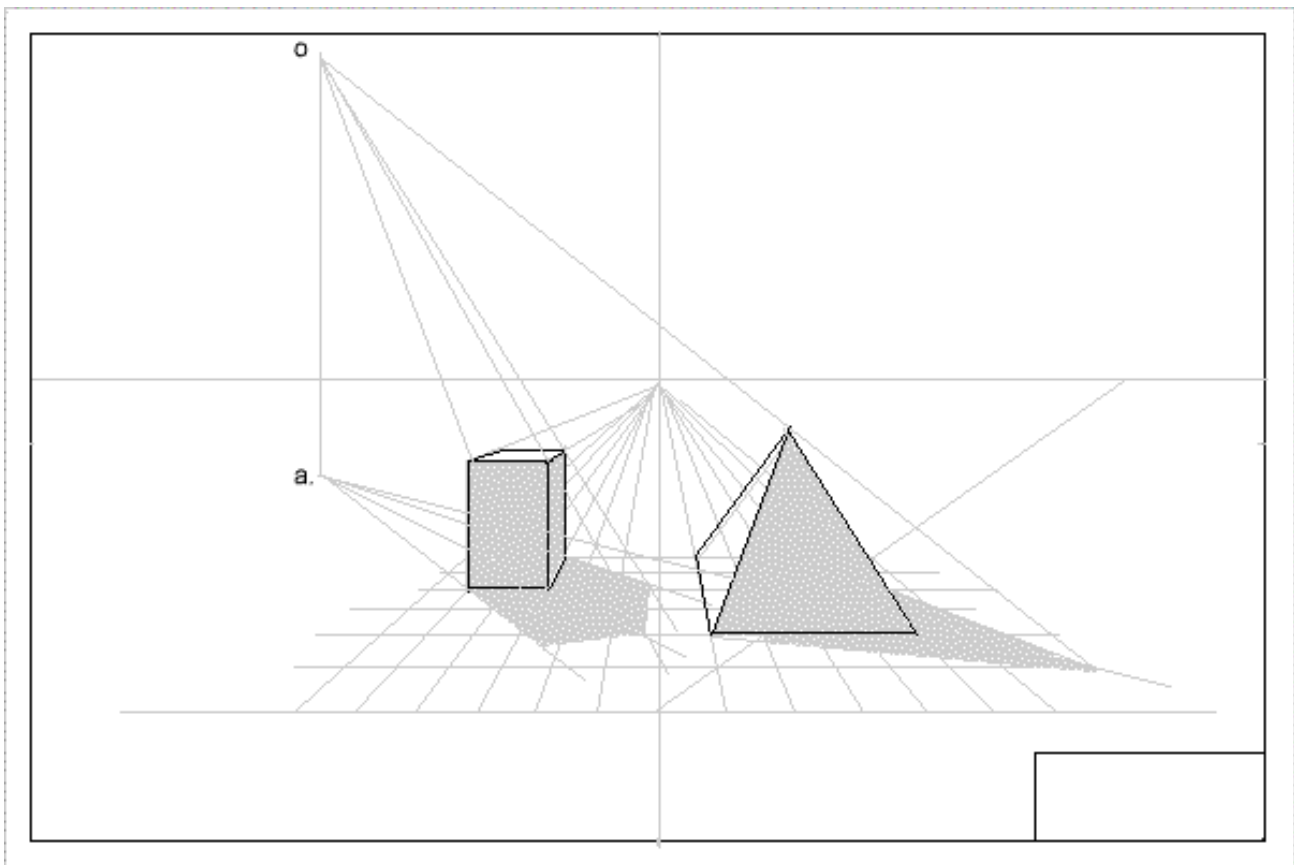

i) Construct and complete the shadow as shown and shade it in. The student should note that if point 'a' is brought forward the shadow will point backward.

Home study :

Experiment, try adding some other objects such as vertical poles and draw their shadows.



[GO TO ... LESSON NINE](#)

[lesson menu](#)



LESSON - PERSPECTIVE NINE - SHADOWS 2

TIME:

Allow 40 min

Aim:

To learn how to plot shadows on differing surfaces. Here we shall plot and draw the shadow of a ladder leaning against a wall.

Materials:

The sketch pad,
HB pencil, ruler.

To Begin revise: Method of introducing light source and estimating its ground position. Ask which way the shadow should be directed, forward or back.

Construct margin and title box on a new page then:

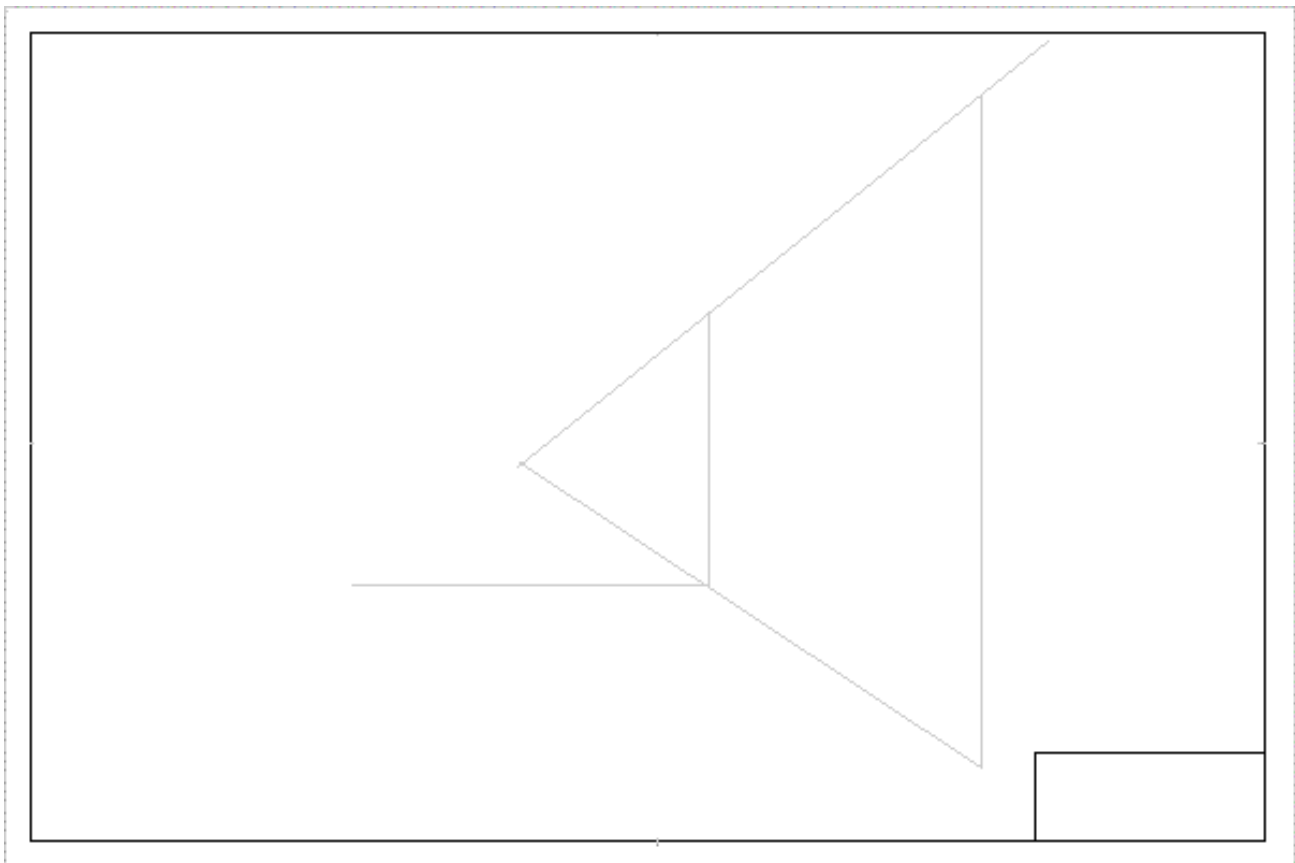

b) Construct the simple corner of a room using a CVP.

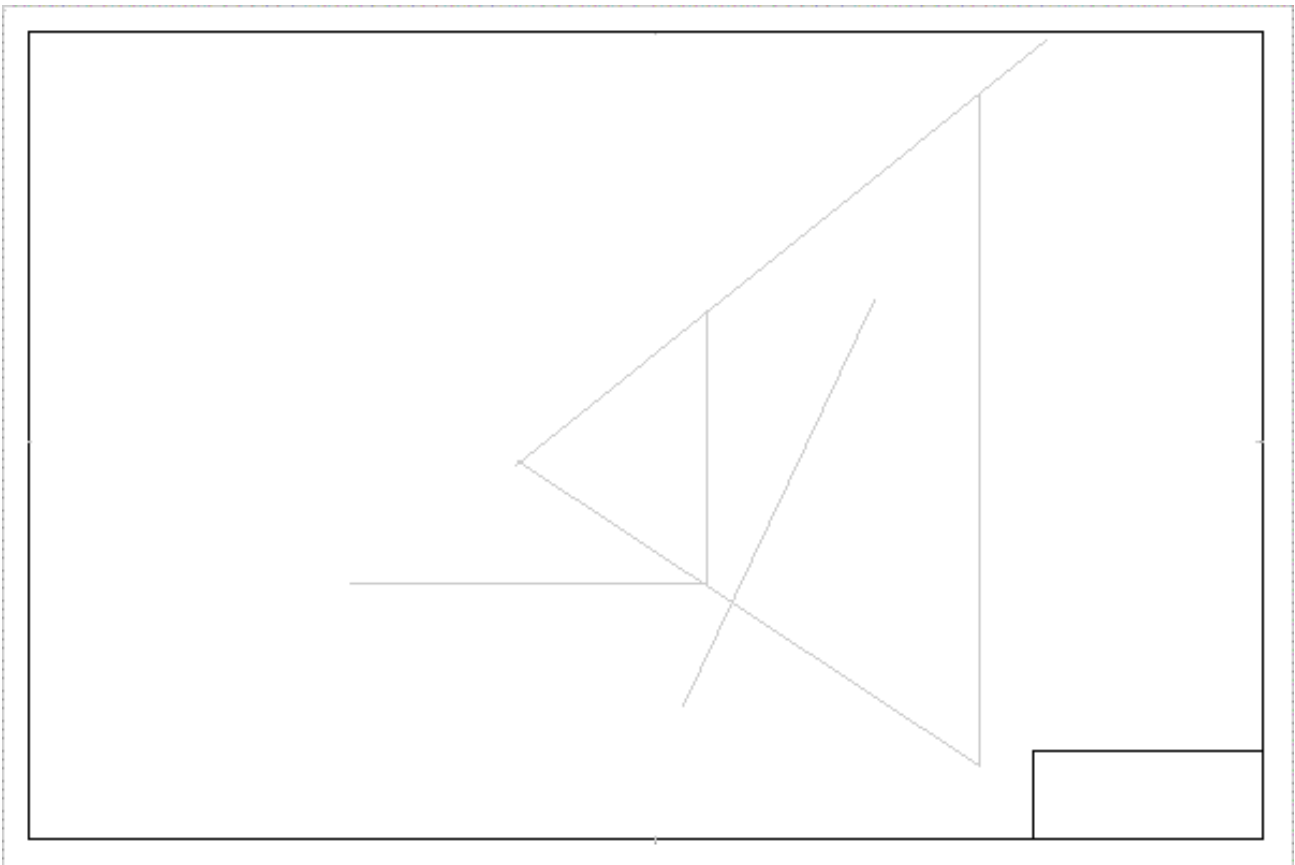

c) This 'oblique' line will represent one runner of the ladder. Call it 'ab'

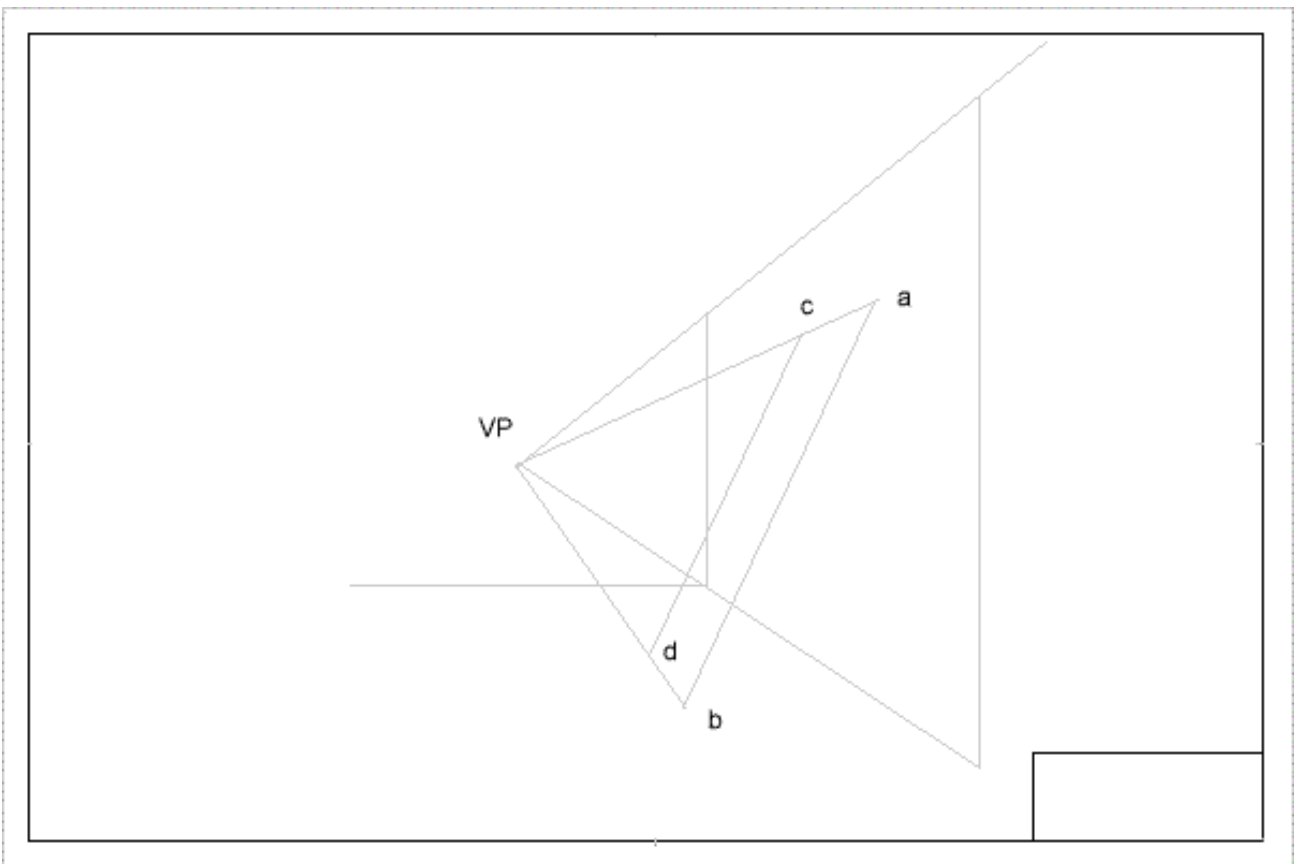

d) 'cd' is parallel to 'ab'. Construct as shown with lines to VP.

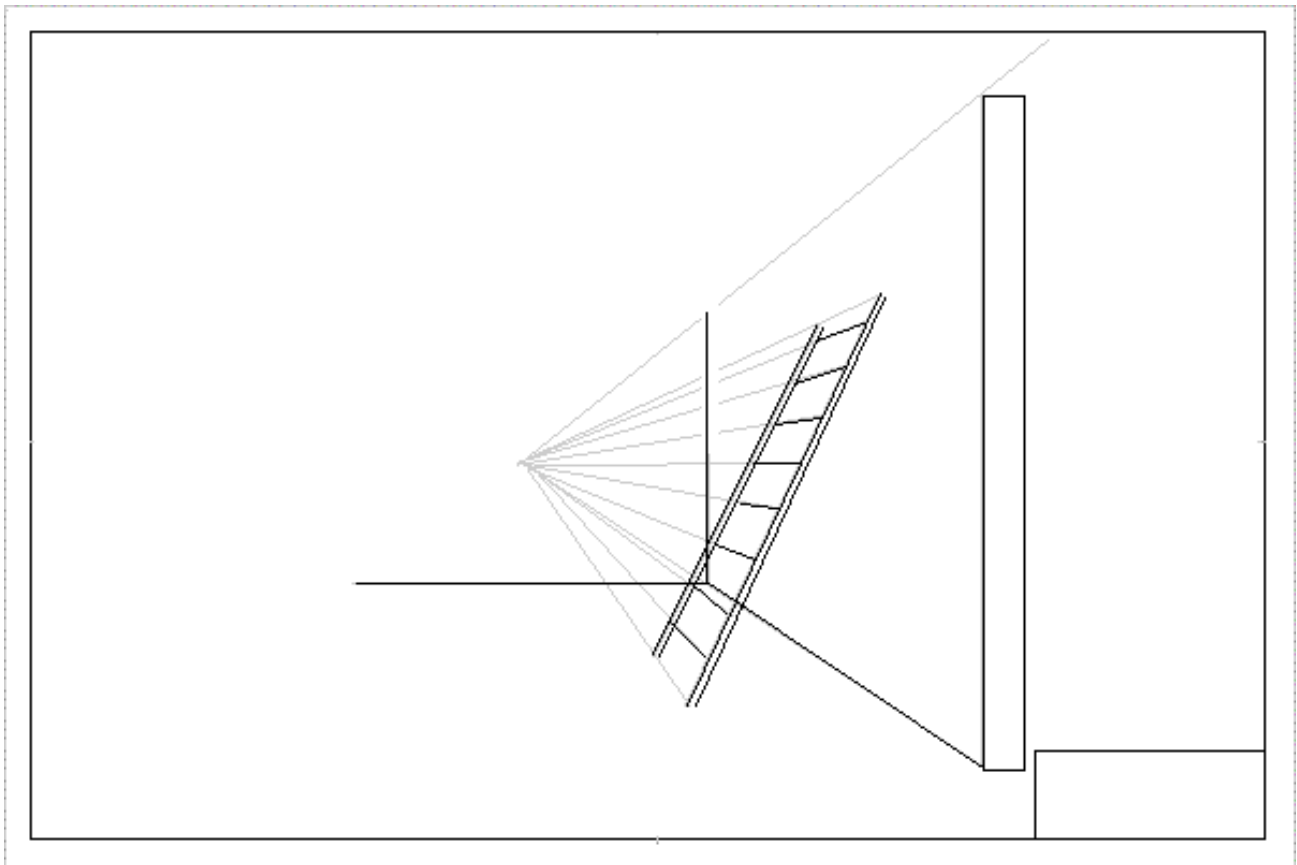

e) Add the ladder 'rungs' and firm them in.

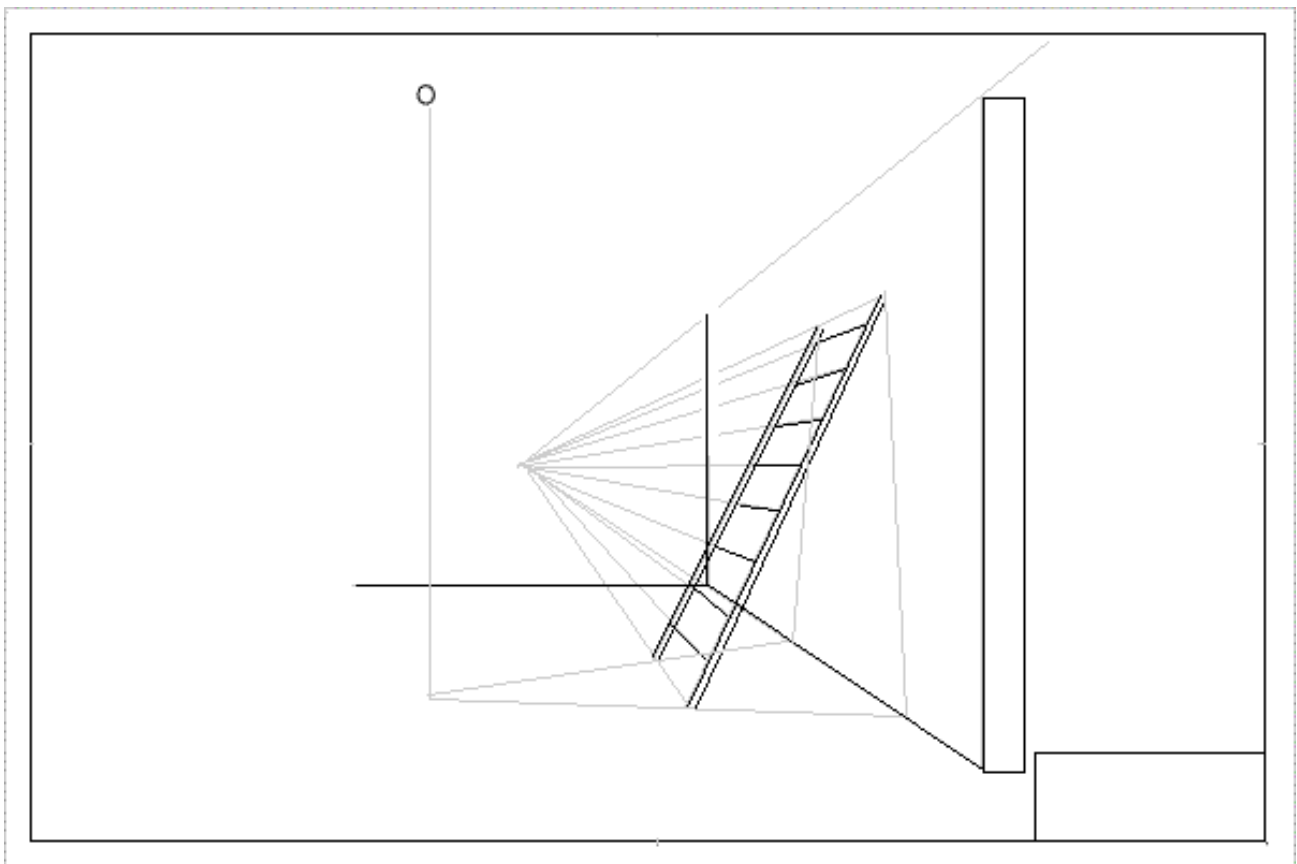

f) Establish the light source - drop to floor and construct shadow lines as demonstrated above.

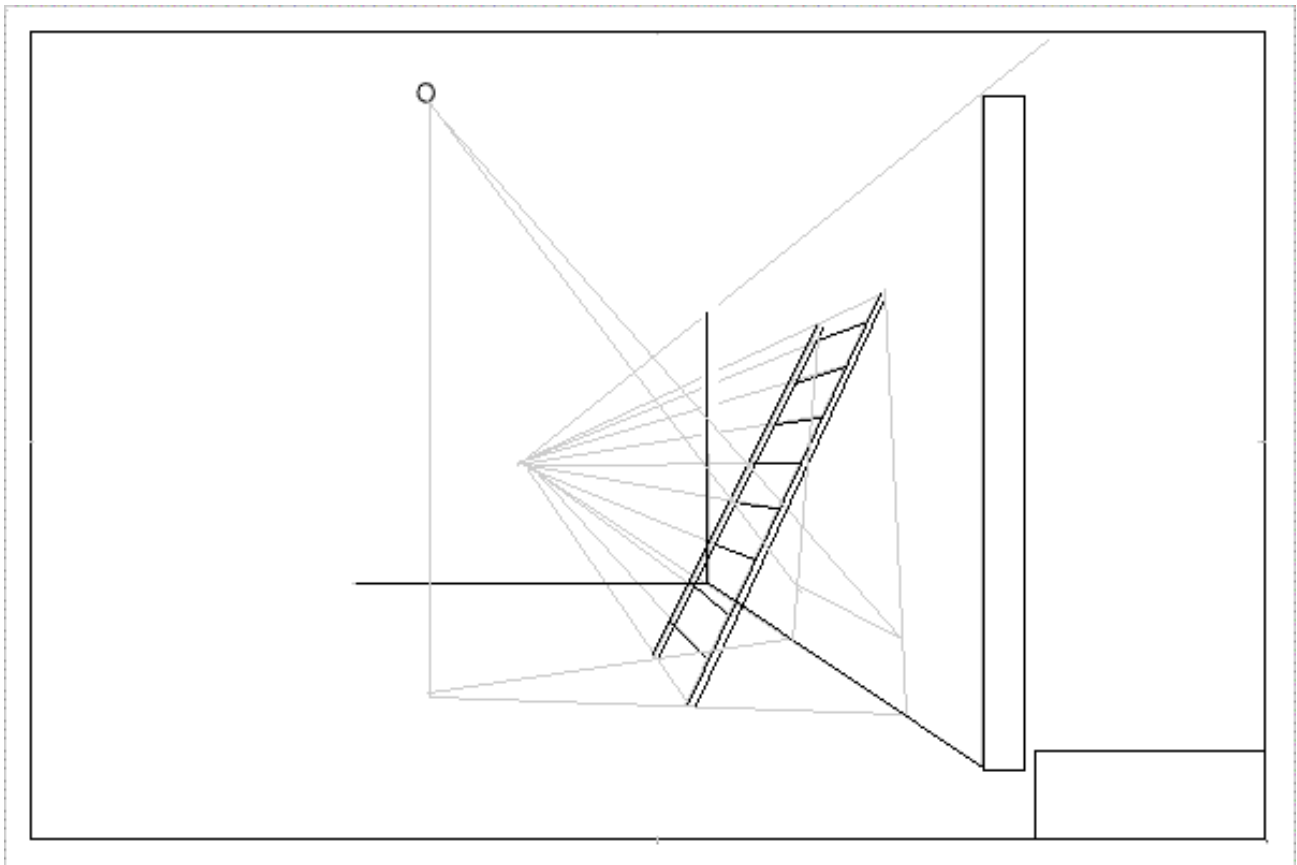

g) This diagram shows the method of constructing a shadow cast by one of the 'rungs.'

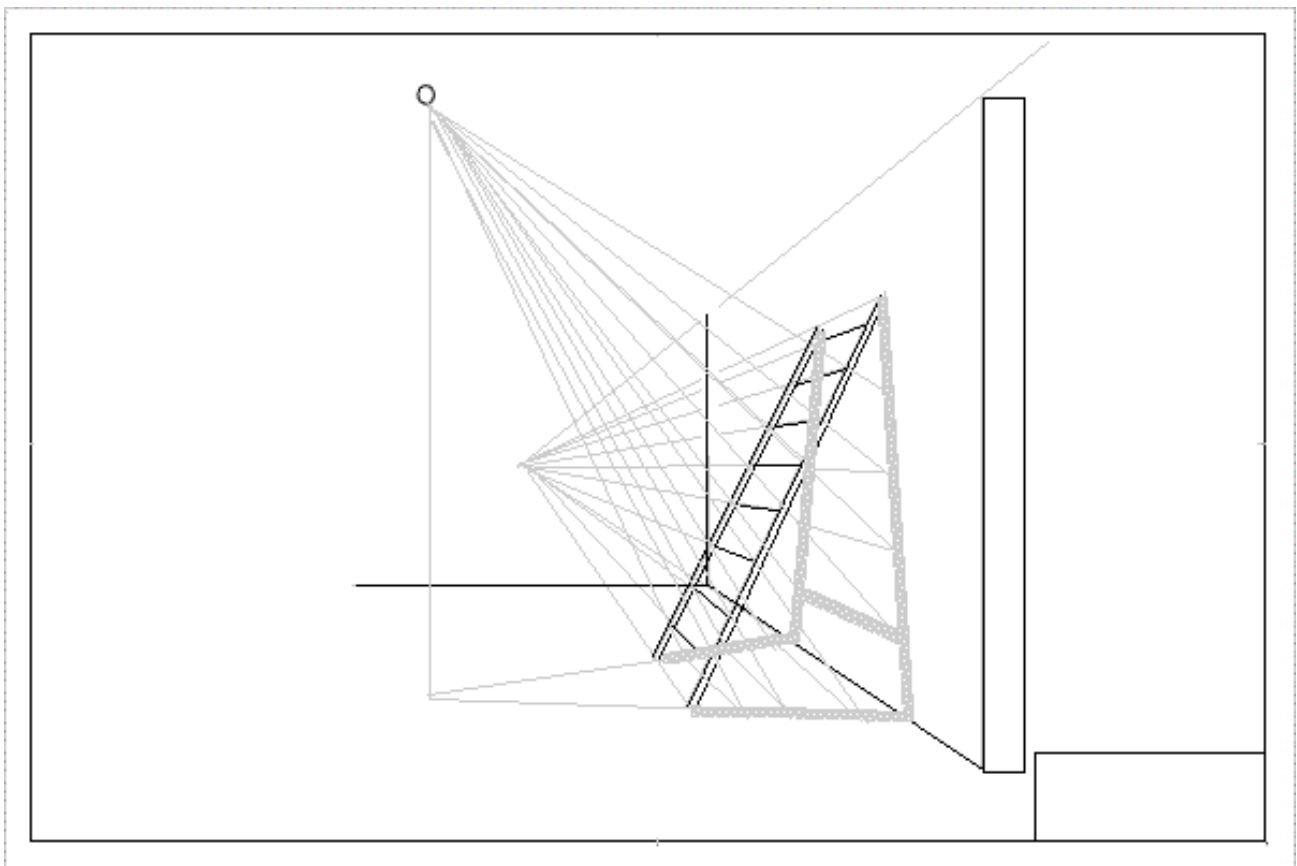

h) Shade in the shadow 'freehand' as shown.

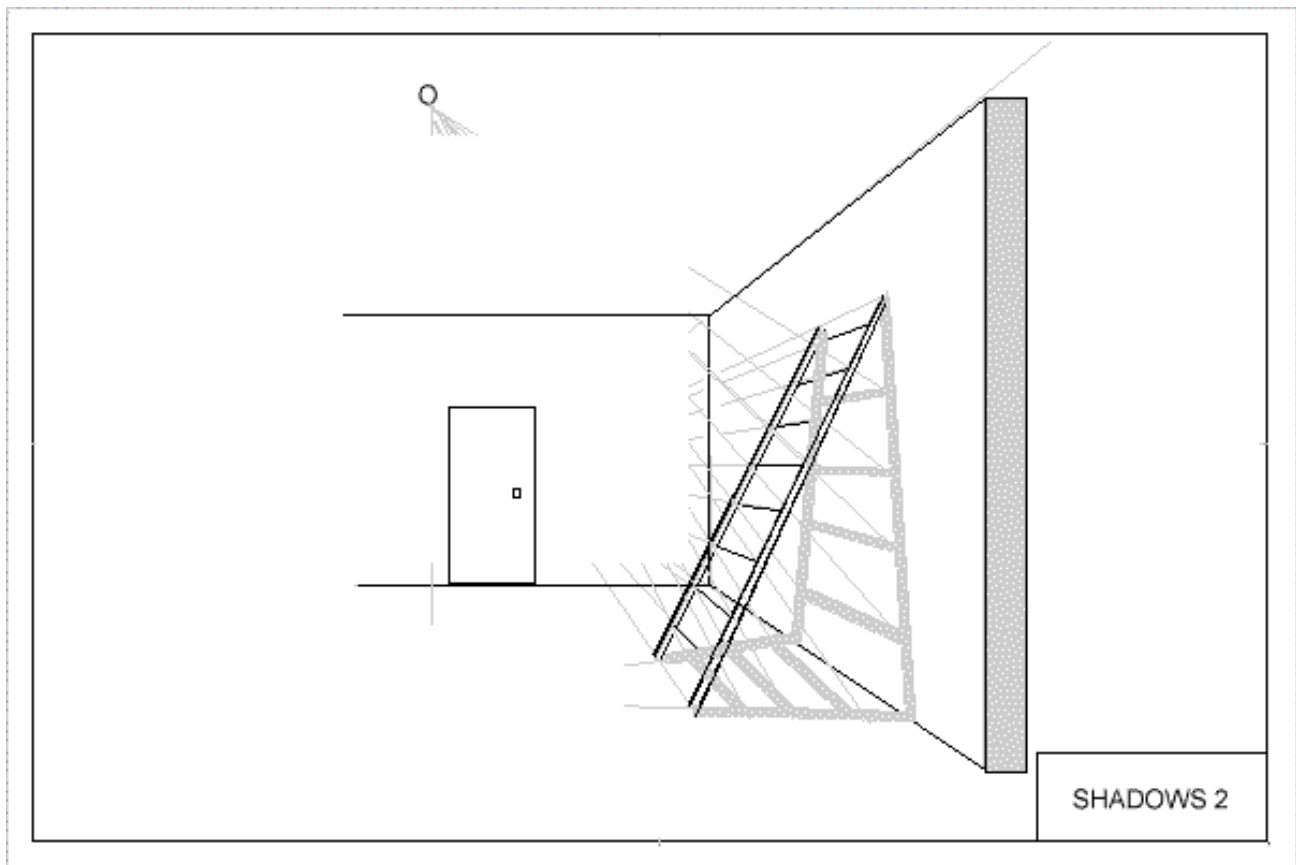

i) Complete the shadow and add other appropriate details

Home study :

Experiment, add other objects ... a bucket on the floor and its shadow.



[GO TO ... LESSON TEN](#)

[lesson menu](#)



LESSON - PERSPECTIVE TEN - ARCHWAY

TIME:

Allow 80 min - best broken into two sessions with set homework in between.

Aim:

To draw a Roman style triumphal arch utilising a freehand approach to drawing lines. This lessons eventual success will depend on the student eventually NOT drawing a straight line ... and thereby not being terrified of making a mistake.

Materials:

The sketch pad,
HB pencil, ruler.

Construct margin and title box on a new page then:

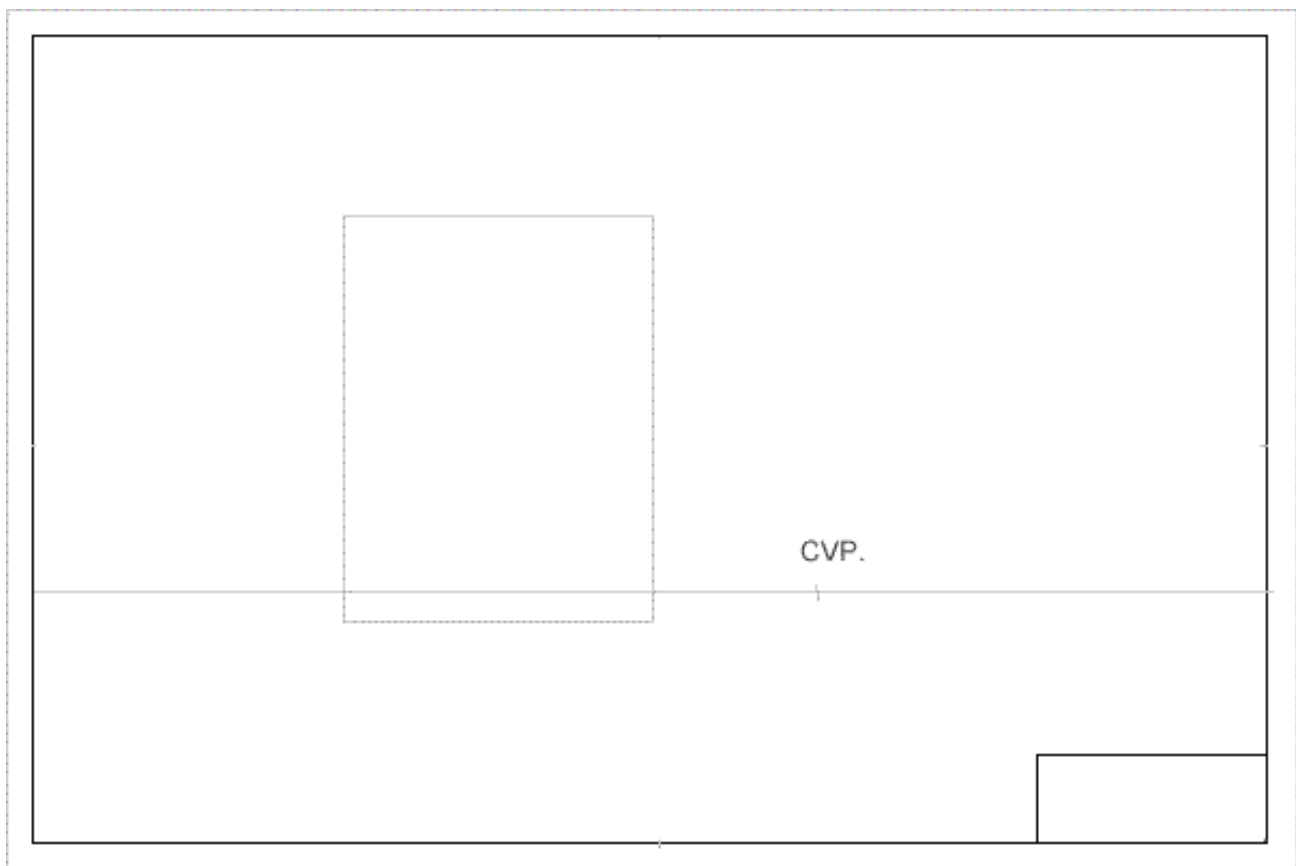

b) Construct the rectangle and place a CVP in the approximate positions shown above.

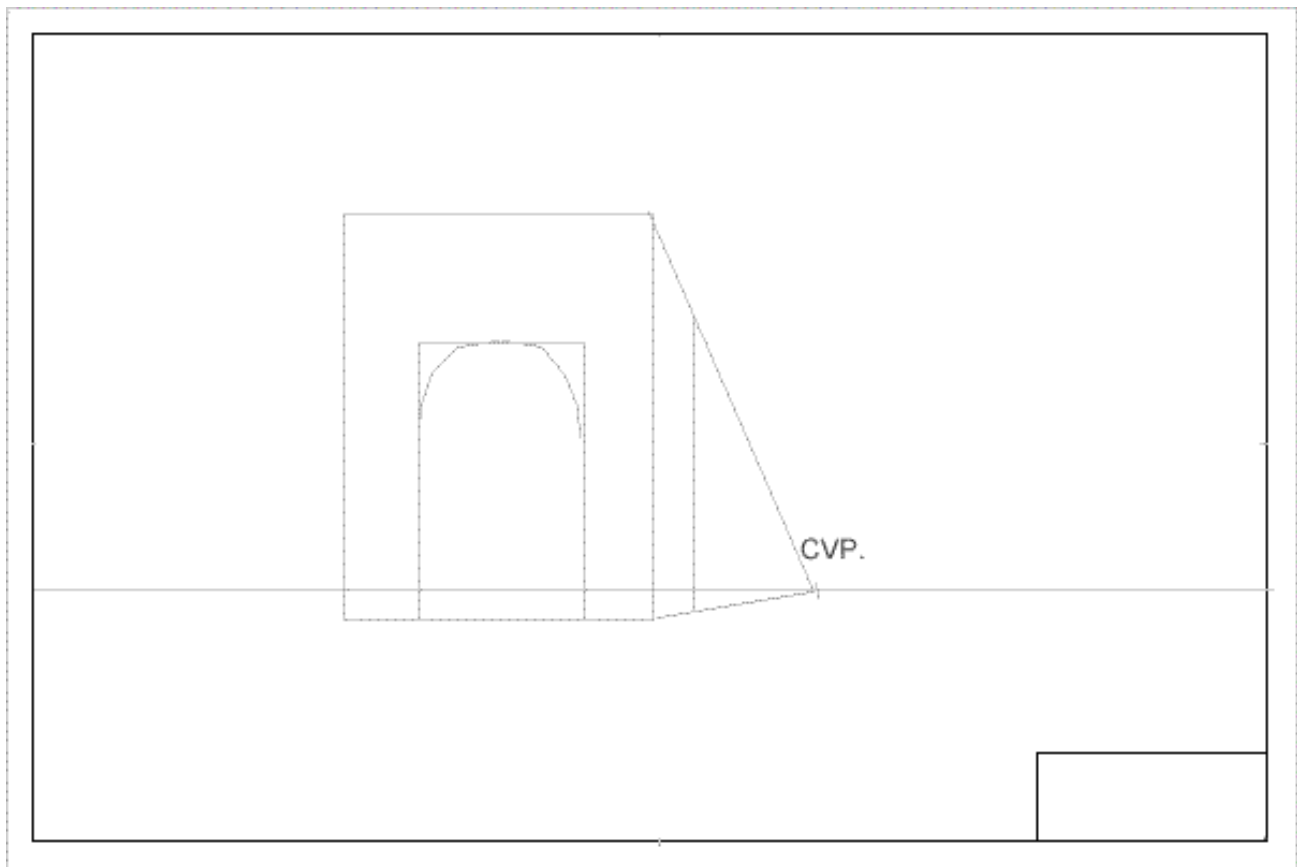

c) Lightly draw the arch with the proportions to approximate those above.

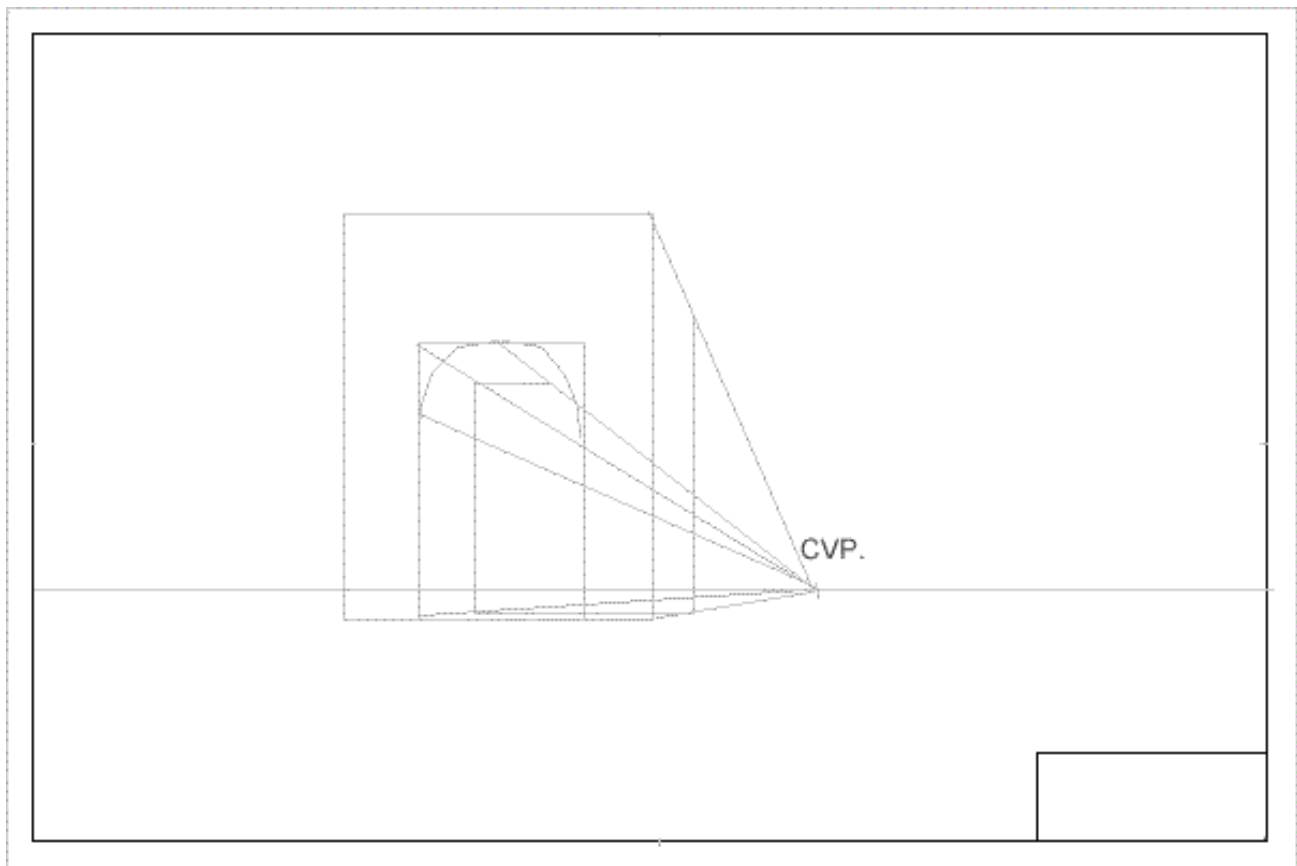

d) Note the method used to position the back (inside curve) of the arch. The intersection point with the front curve is critical.

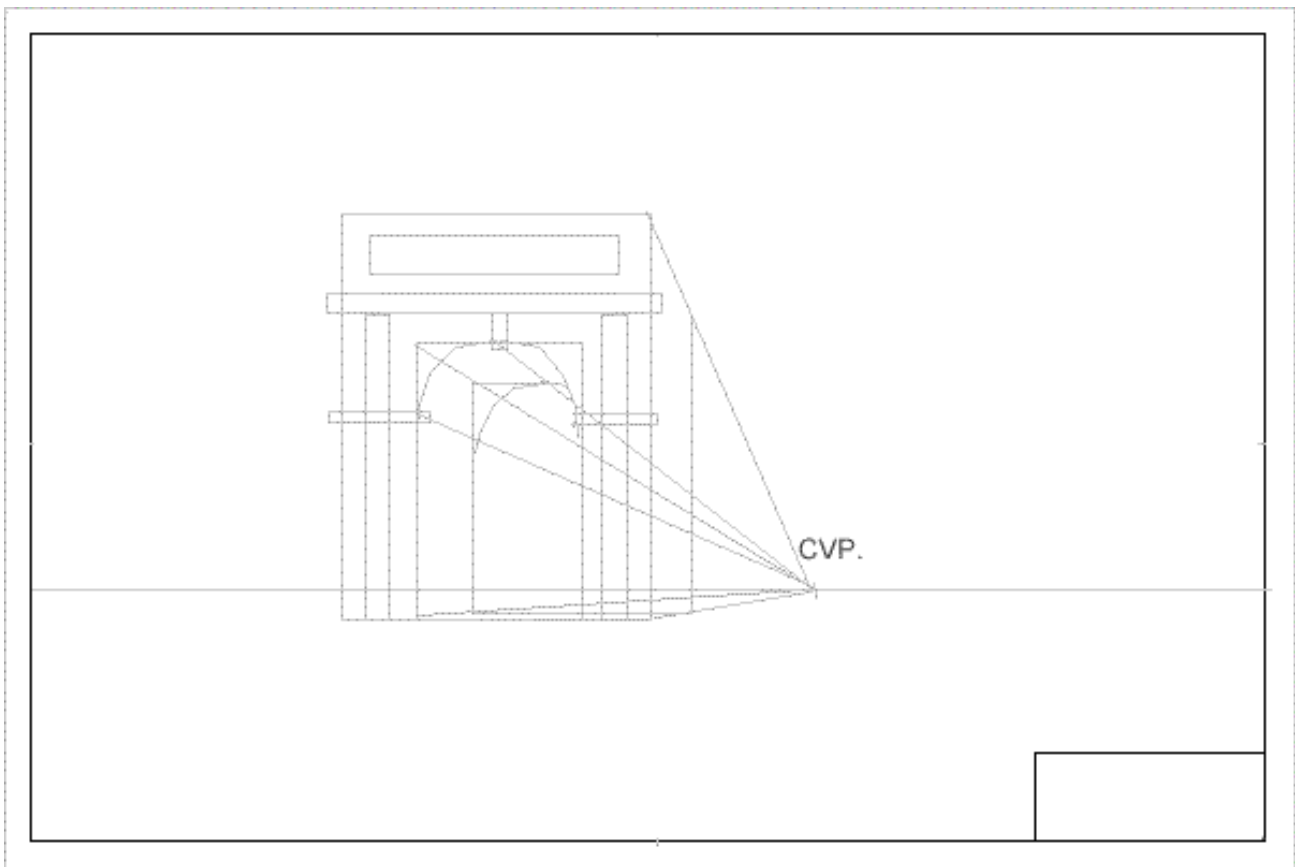

e) Add the 'minor' rectangles as shown on the face of the arch.

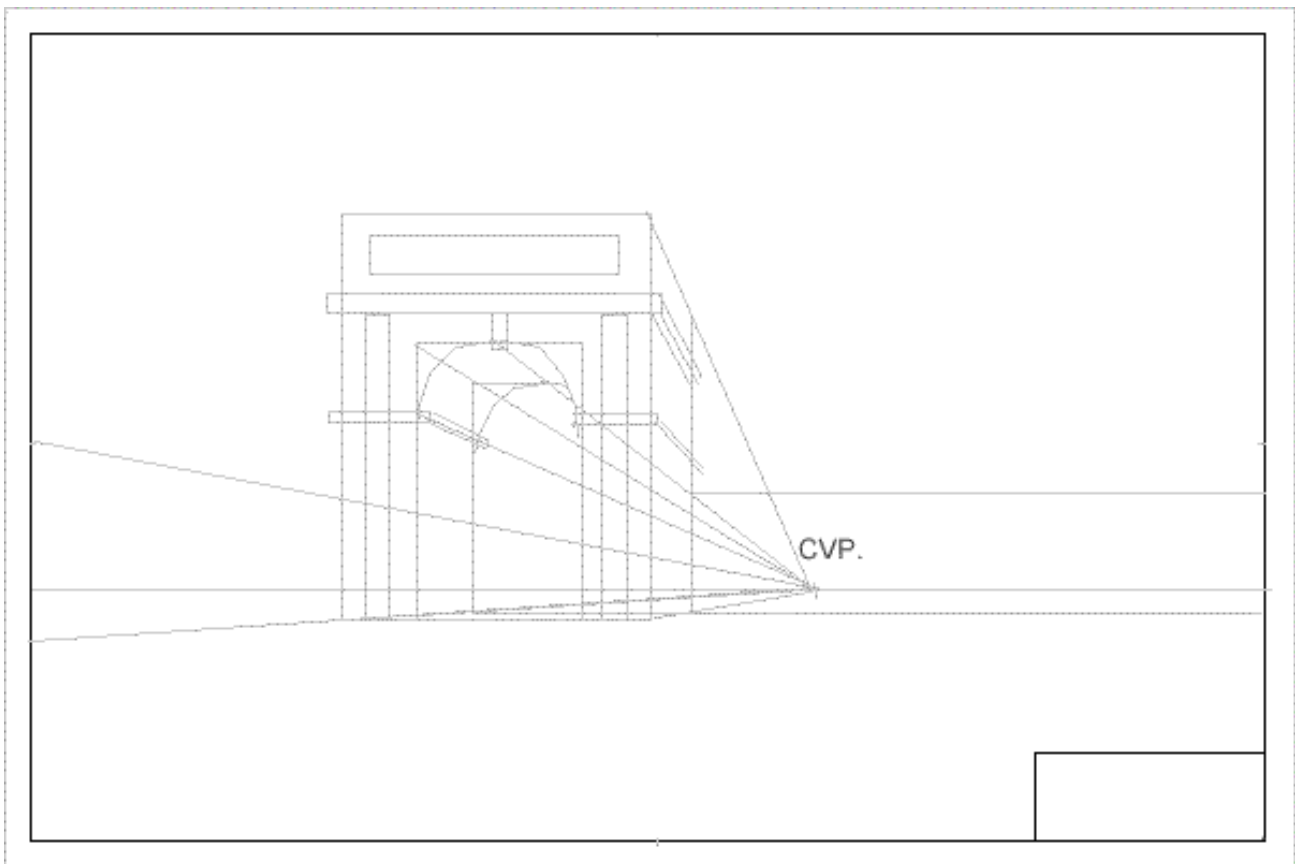

f) There are two walls indicated and lightly sketched in as above. You will see their complete form in the drawing shown next.

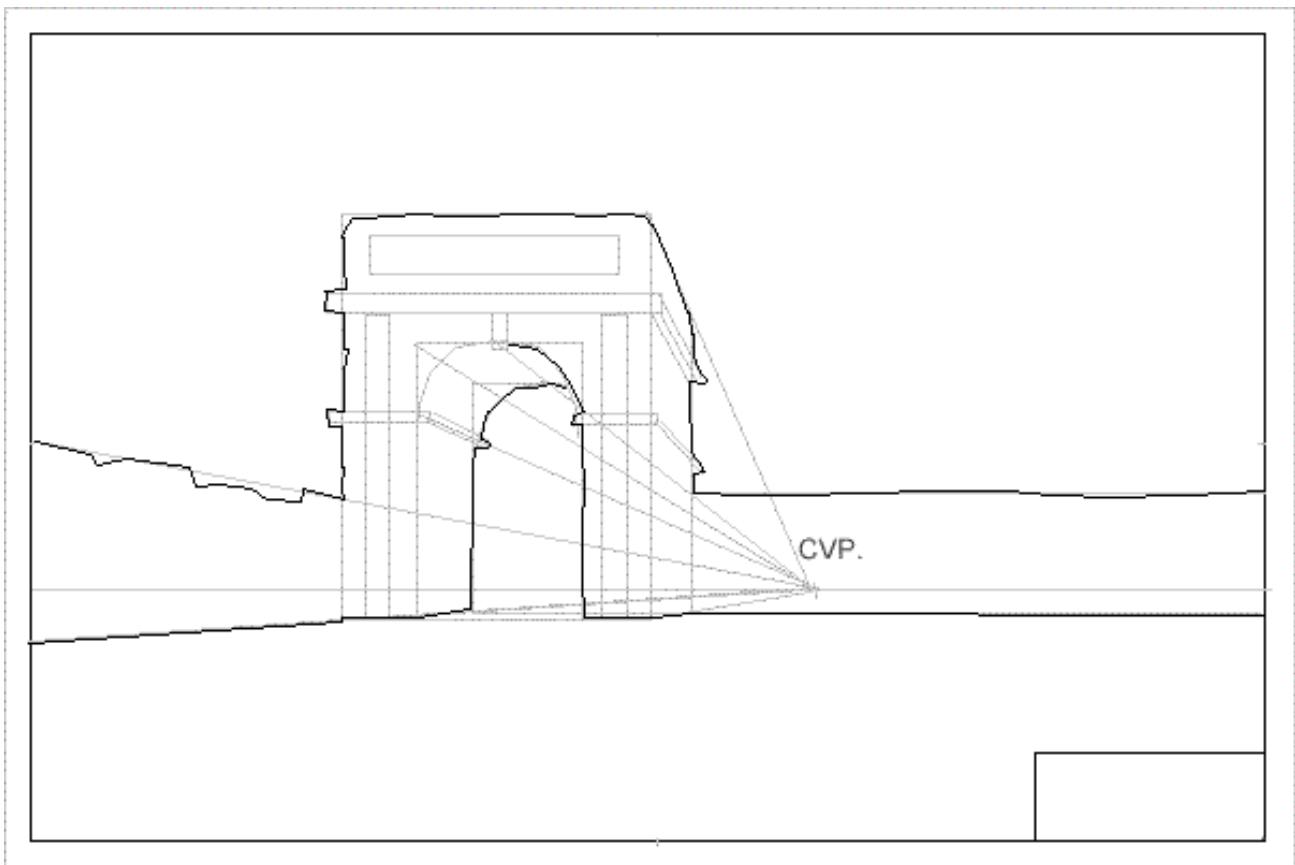

g) The student must now discard the ruler. All the firm lines must be done 'freehand'. Any ruled lines will look inconsistent and out of place. Use short firm strokes rather than trying to be too ambitious. This arch is supposed to be old and decaying therefore irregular lines are what is required. Now the arch and its surrounds should begin to take form.

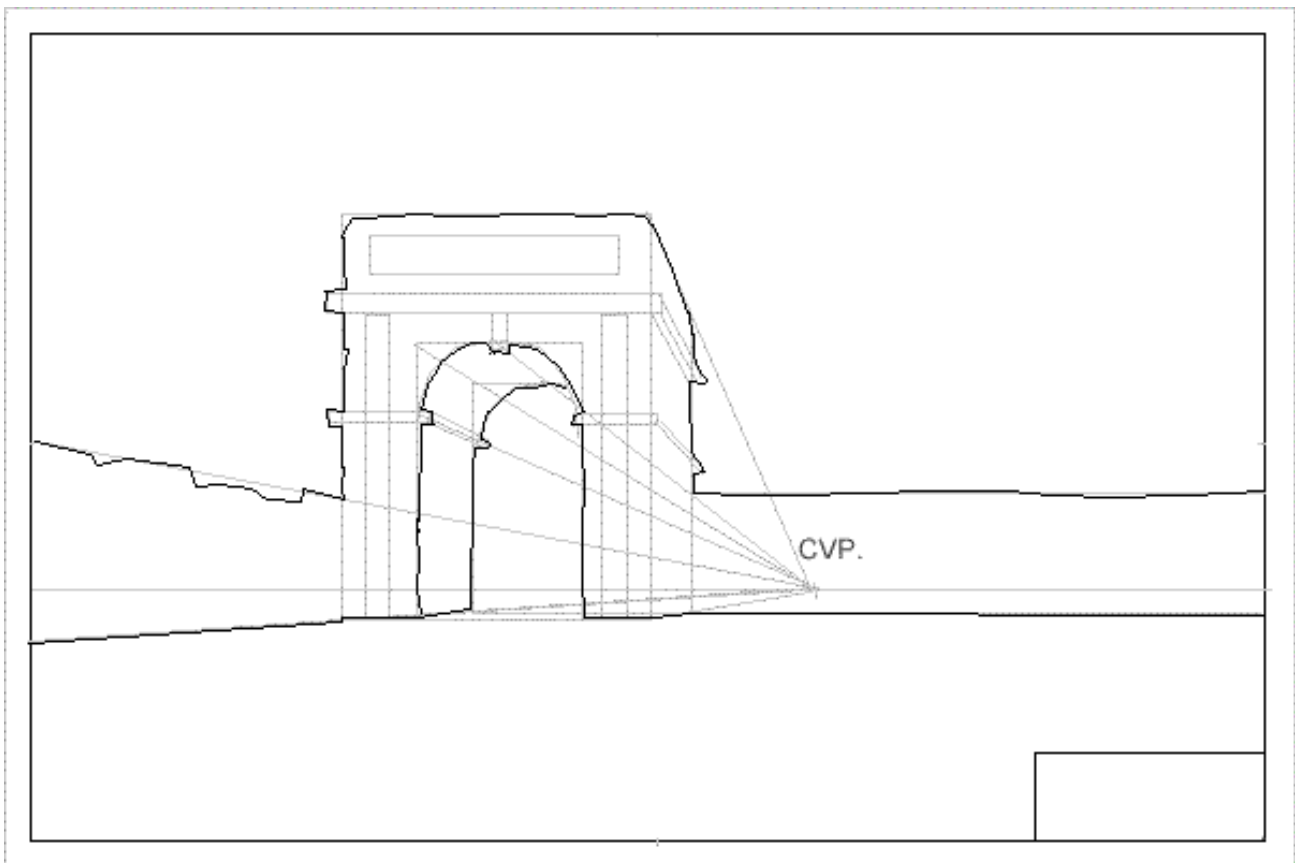

h) Clean it up and add some shading.

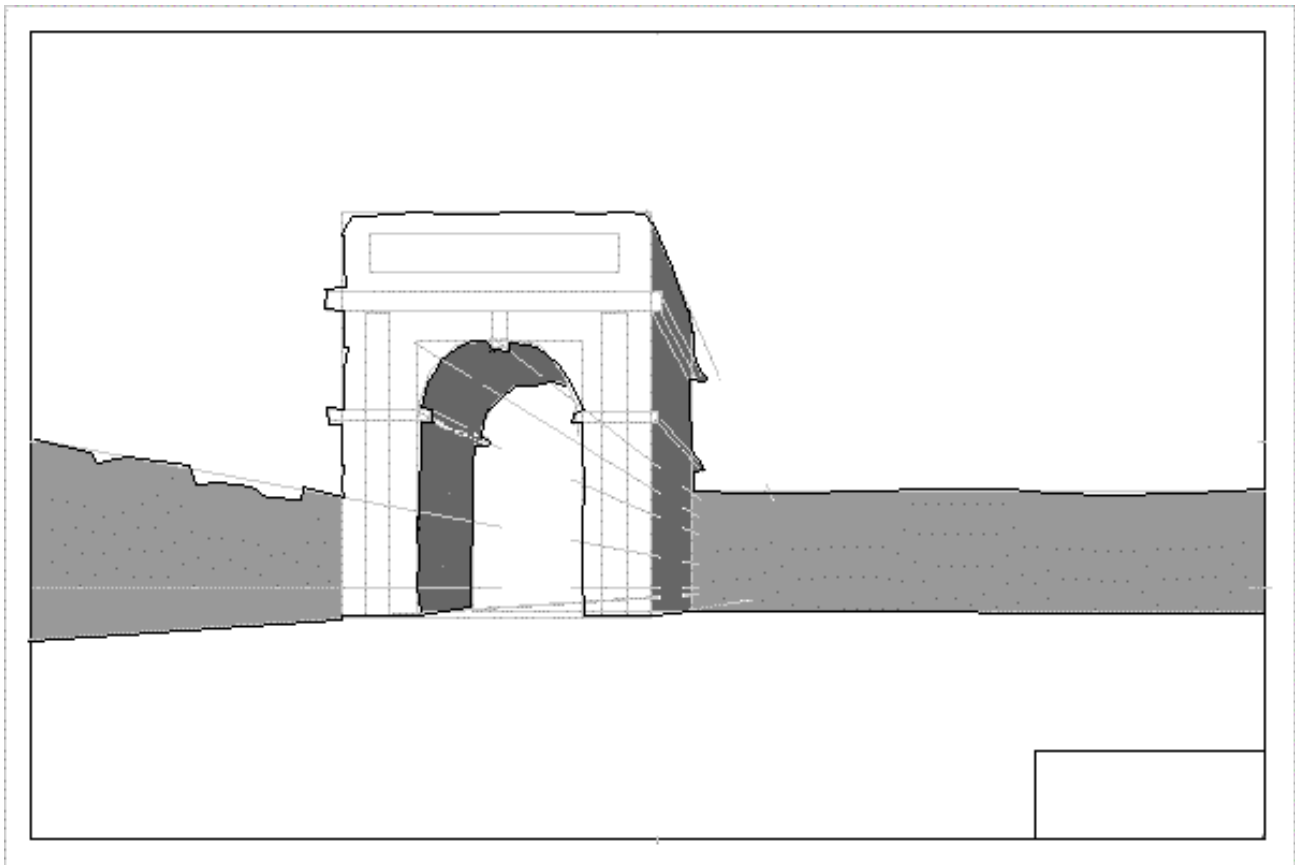

i) The light source is to be from 'top right' so shade the raised frontal areas on the arch as shown ... shading to the right and below.

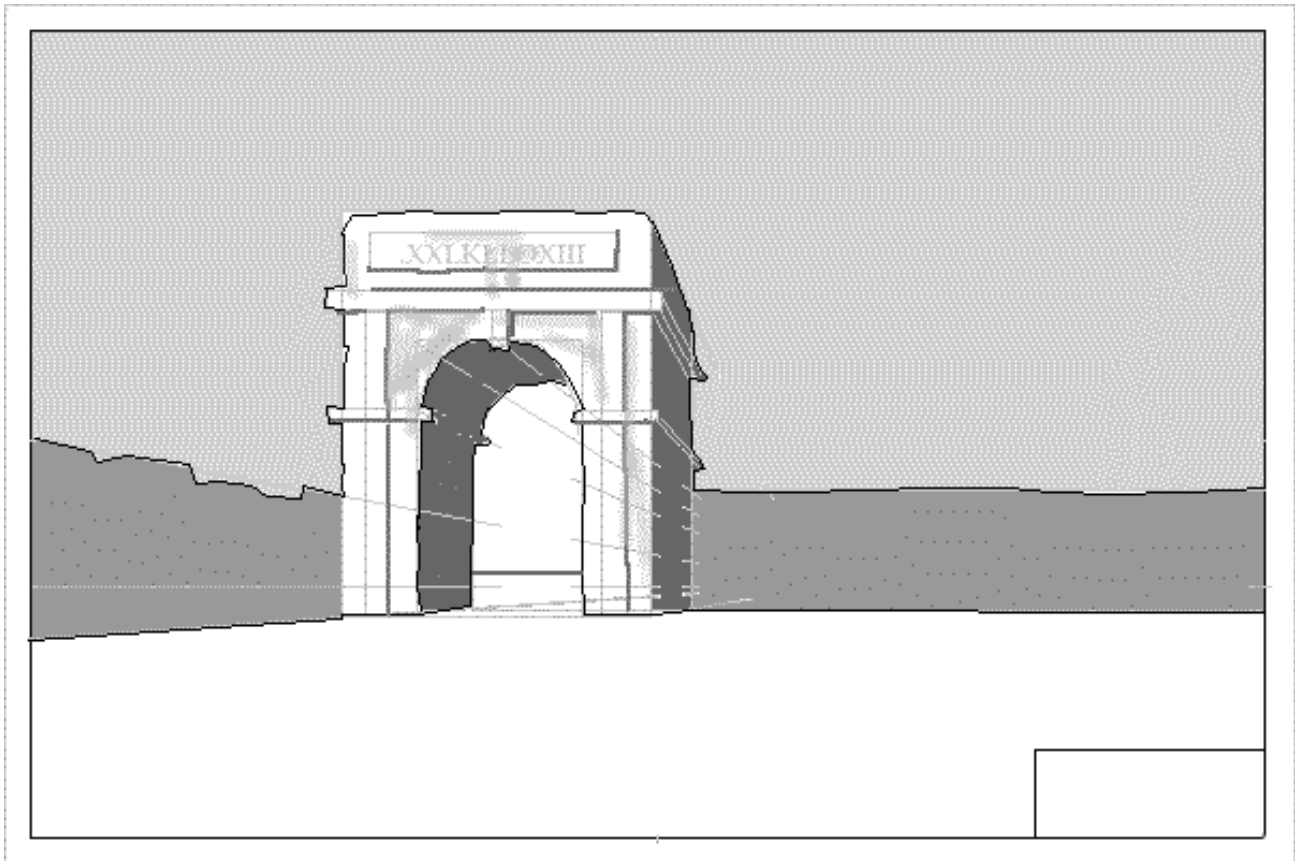

j) Add some 'Roman' letters (the detail is where observation and creativity interact) and shade some areas...

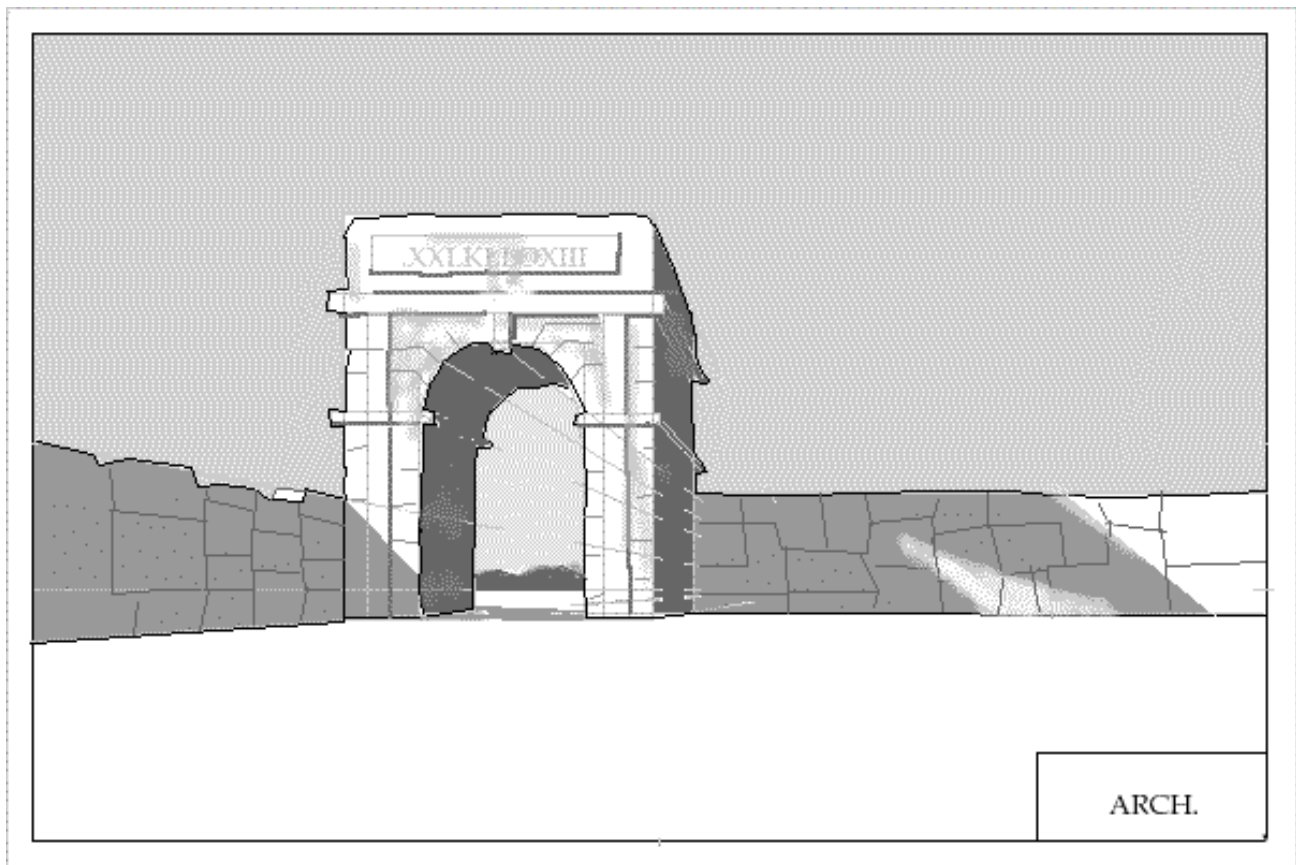

Note the shadows. At this juncture the shadows are merely 'parallel'. Since the drawing is not complicated regarding 'shadows' and the sun is very high and distant we can assume an almost parallel set of light 'rays'.

Homework: This particular arch is a minor detail in a painting by a well known artist who was born in Venice on October 18th. 1697. It appears in at least two of his paintings. The student to gain extra marks for naming the artist and even more for naming one of the paintings that contain the arch. Additional marks could be awarded if the student were to name the origin of the arch.

CONTINUED...



[GO TO ... LESSON TEN \(CONT.\)](#)

[lesson menu](#)



LESSON - TEN ... CONTINUED

Aim: To reinforce the notion of 'logical size'. The size of objects being determined by introducing a familiar object at the same 'level' (a similar distance from the viewer). Then to complete the drawing started in the previous lesson.

The teacher should print off the following three drawings and hand them out as reference drawings.



a) Here I have introduced 'the admiral' and put him in the arch. Suddenly the arch has a particular and definite size. Ask the students, why is that?

From the moment a baby opens its eyes it begins keying-in shapes, with one of the first being the human face and body. Then it learns to recognise various other shapes in order of their importance. The child also learns to judge how far or how close is a particular object. Ask the class how this is done?

You could mention that these common perceptions are what bind people together. There are, of course philosophical implications here concernig the commonality of experience ... but that is what drawing is all about!

Anyway, in the order of things human the body is a far more dominant form than any old archway.

This body of our 'Admiral Cowdisley Shovel' determines the size of the arch (how high is it here?) as we all know the average height of the human body, but, what if we shrink the poor old sailor?

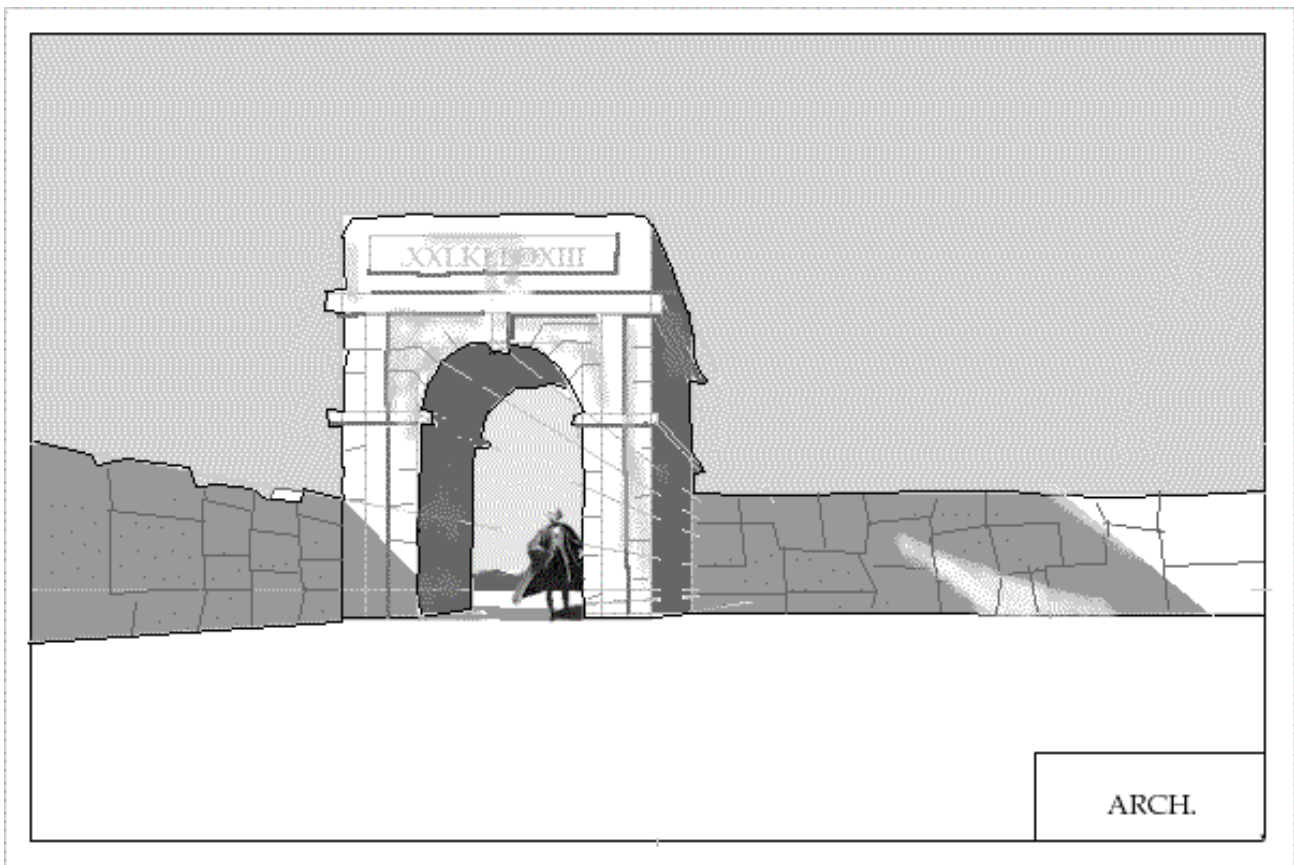

b) Suddenly the arch has grown. How tall is it now?



c) OK so now I have multiplied the figures and drawn them forward. If we roughly draw lines through the Admiral's head and feet where would they meet?
Is the person viewing this scene shorter or taller than the 'Admiral'?

Let's go back to our unfinished drawing.

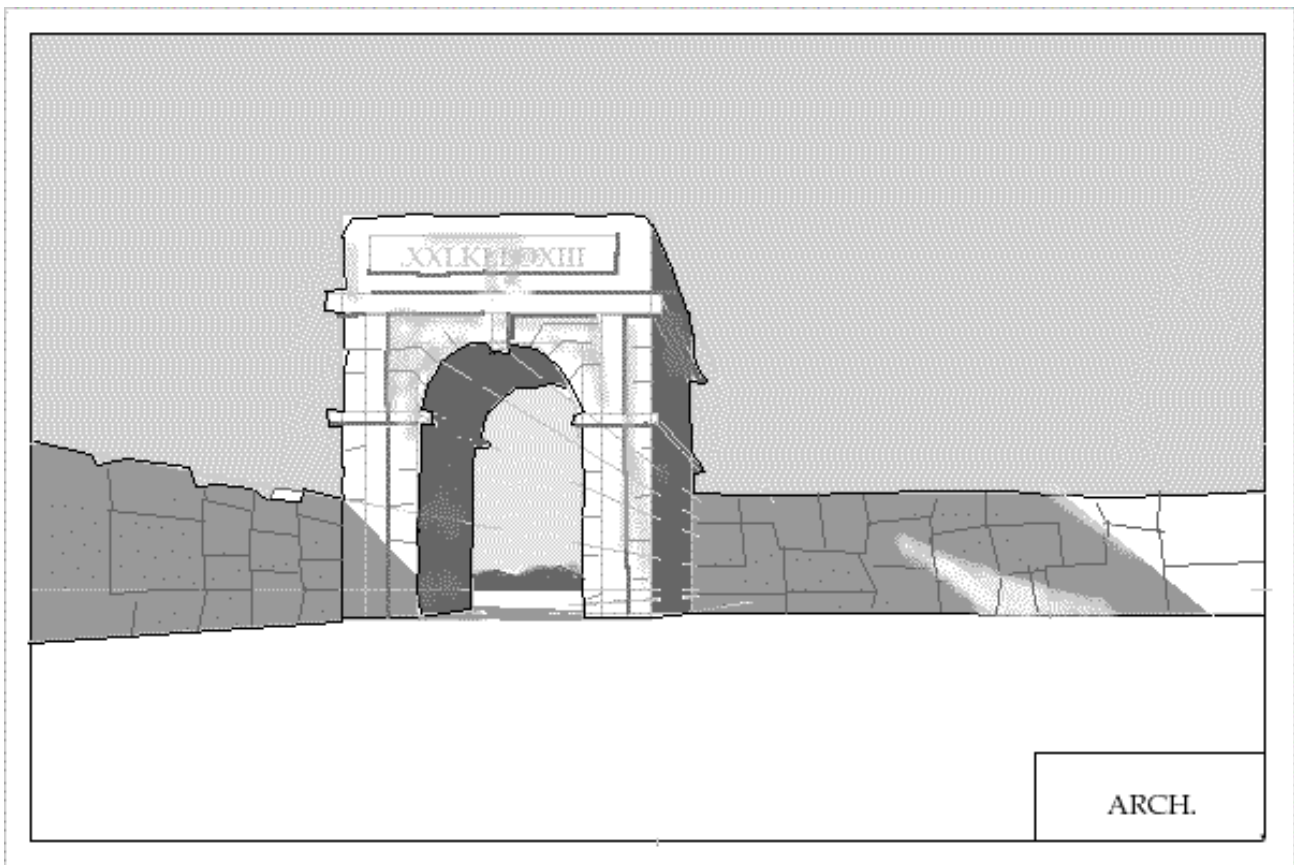

d) Note the detail lines suggesting the blockwork on the arch radiate out from the curve of the arc and then square. This is a tiny detail but one born of awareness. Ask the pupil about laying bricks that will form an arch, or the color of their front gate, or the size of a normal teacup. Test their awareness to common things and ask them to test you.

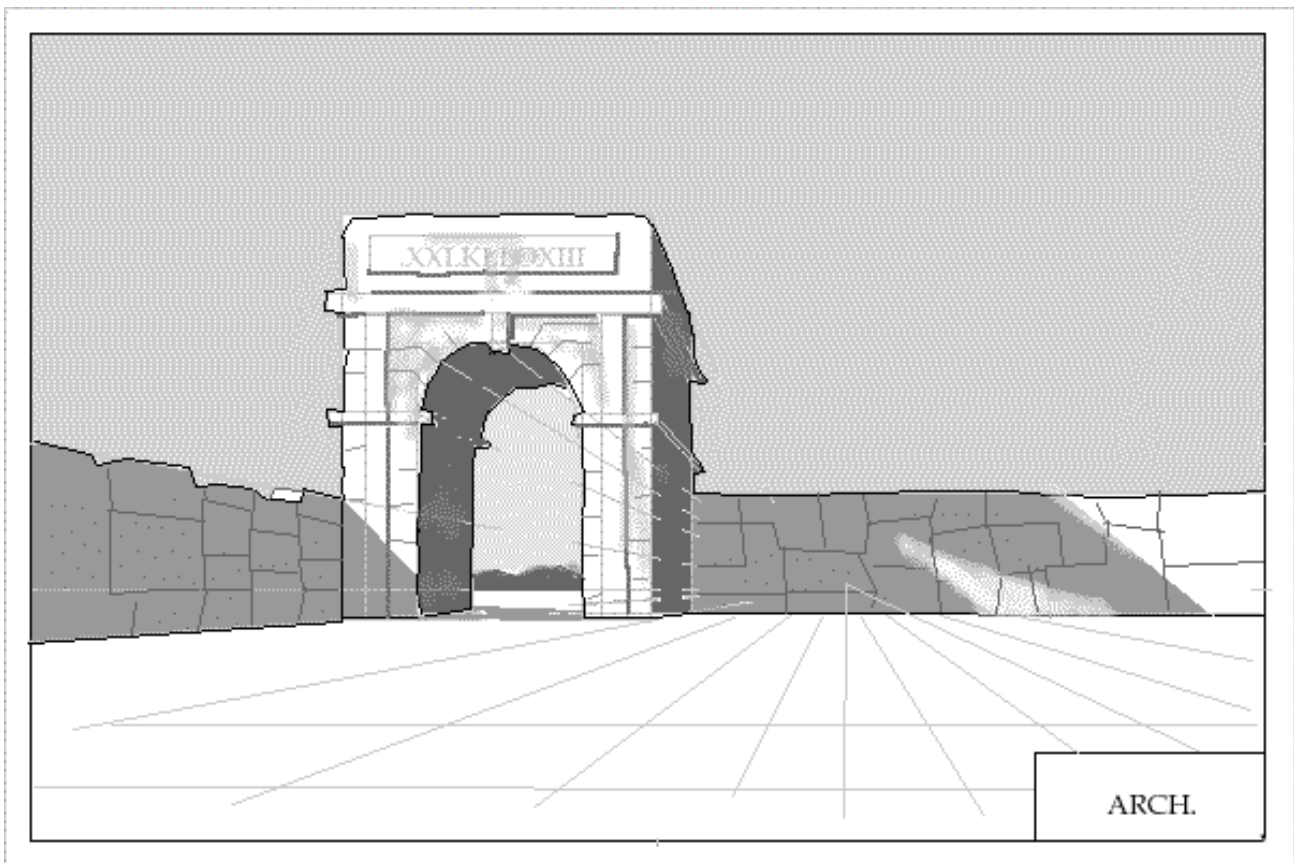

e) Using method in previous construct perspective 'grid' on the ground. Remember the firm lines are to be done freehand.

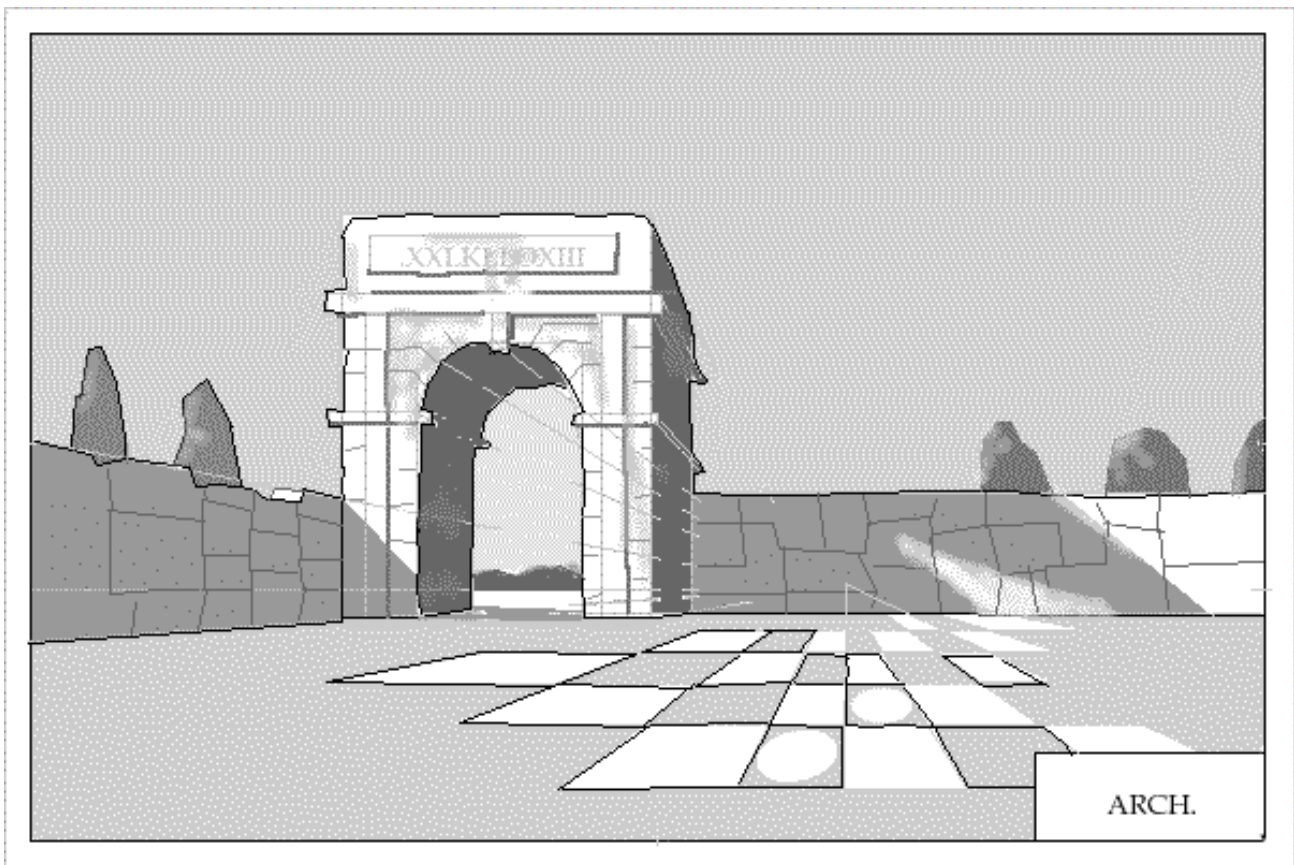

f) The pupil should be encouraged to decide on the design of the forecourt and individualise it as much as possible. Add some trees behind the wall to soften the starkness.

HOMEWORK: Complete the drawing by adding a small figure in the arch.



[GO TO ... THE ROAD - ELEVEN](#)

[lesson menu](#)



LESSON - PERSPECTIVE ELEVEN - ROAD

TIME:

Allow 40 min (TEN MIN INTRODUCTION)

Aim:

To understand the principle of multiple vanishing points and how they work in nature.

Materials: The sketch pad, HB pencil, ruler.

In this, the first part of this lesson the teacher will need to demonstrate the following on the chalkboard or pad ...

Alternatively, if the teacher deems necessary, these first six explanatory diagrams can be printed and handed out. However a quick demonstration on a chalkboard will give **everyone** confidence. The teacher could do this with just ten minutes of preparation ... OK, I know your time is valuable, and I must admit, I never prepared a lesson in my life. I just did it by sensing the needs of the student and seeing where that might lead ...

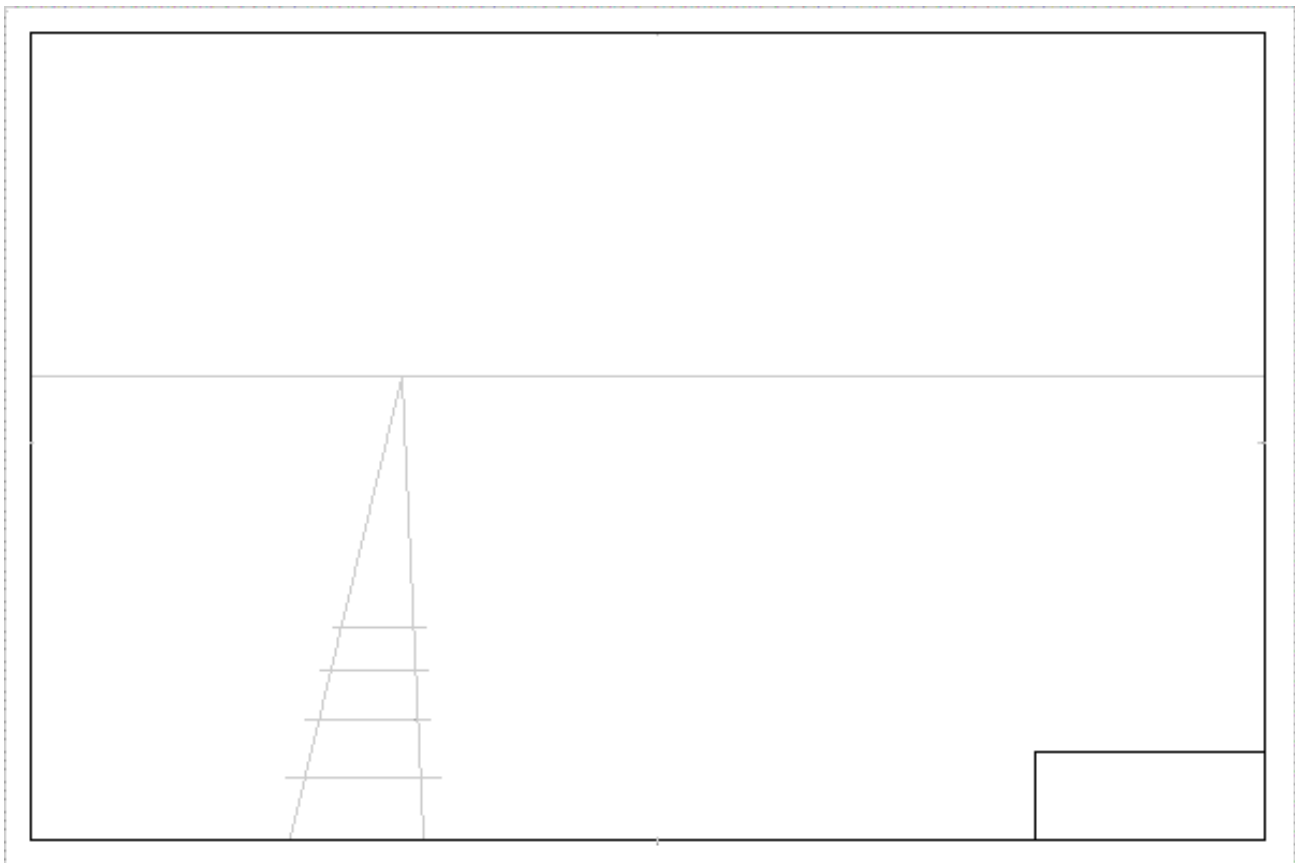

... in a classroom of thirty odd students that is called living on the edge. But then again I am easily bored; anyway, remember our railway line in a previous lesson?

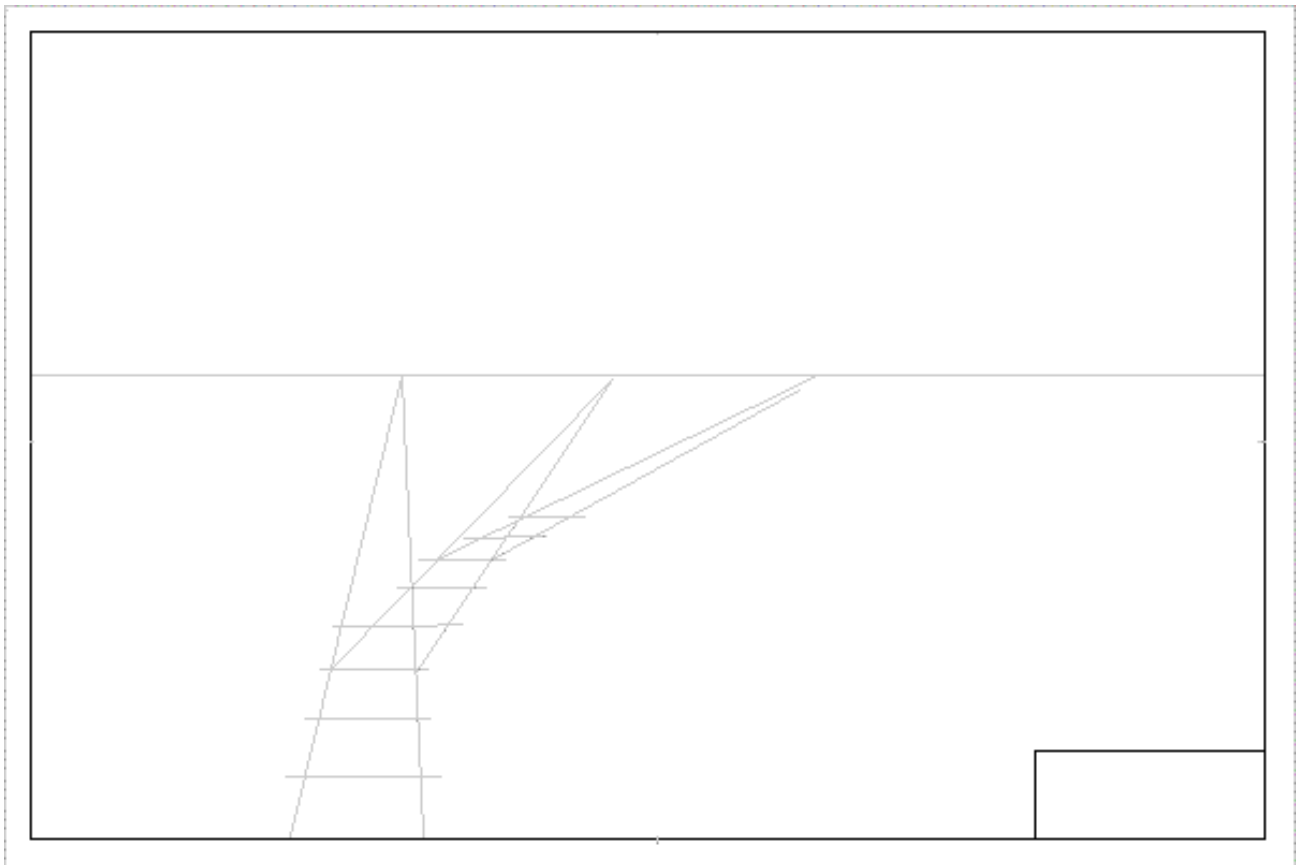

Move the vanishing point along the horizon line to the right as above. Just use common judgement to place the sleepers ... as you might do in any grammar class.

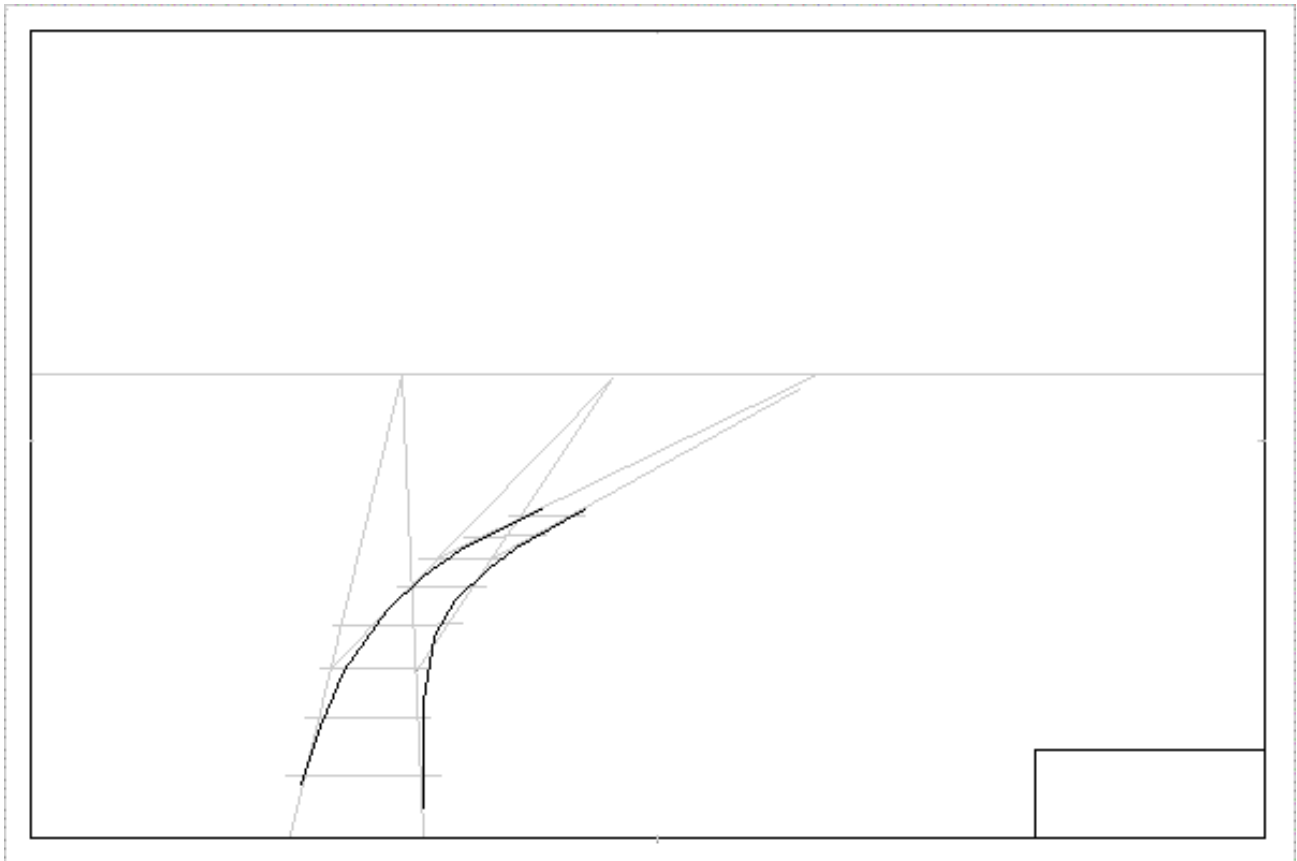

Of course, as the line bends, it does with a 'curve'. Draw in the freehand curve as shown.

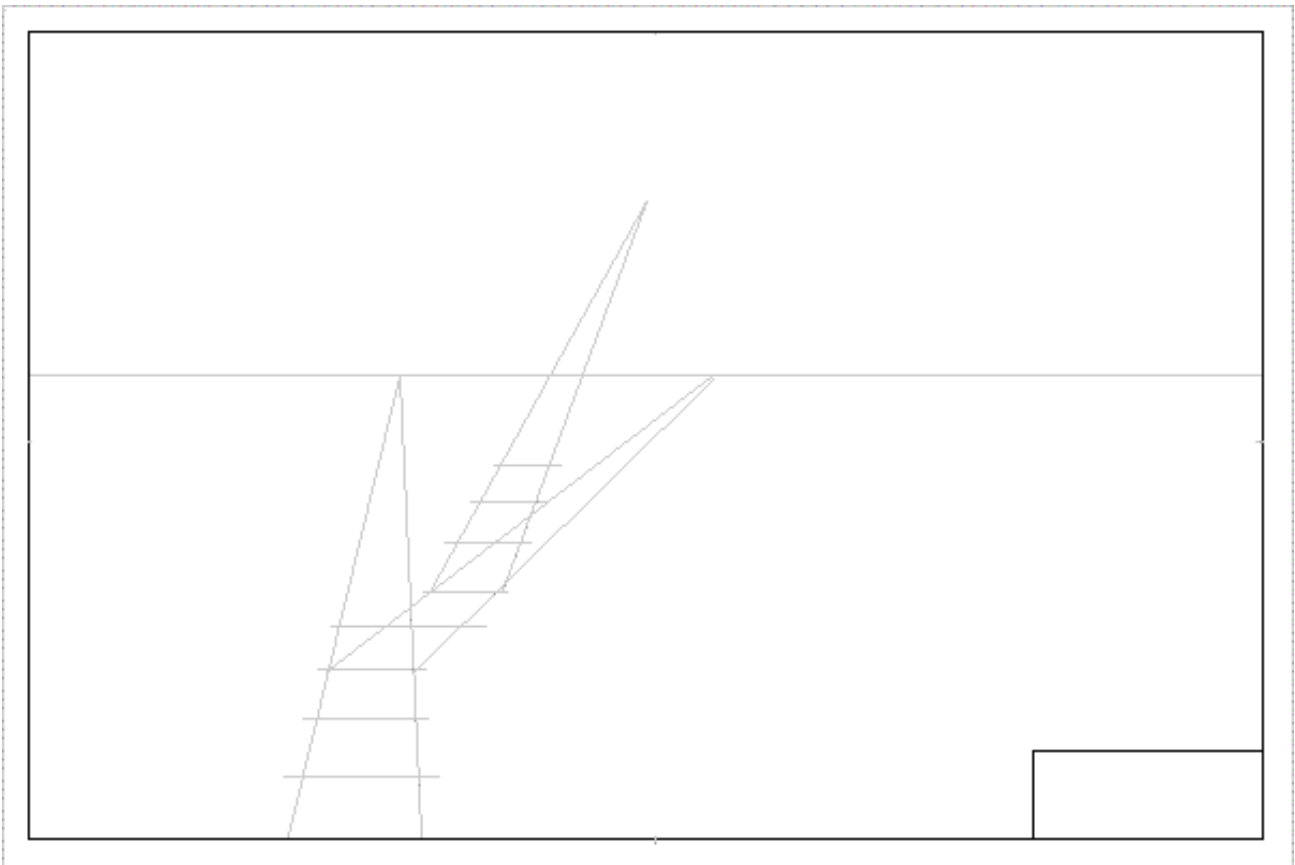

Next, we find a vanishing point 'above' the horizon! This will have the effect of making the line appear to rise up. See above.

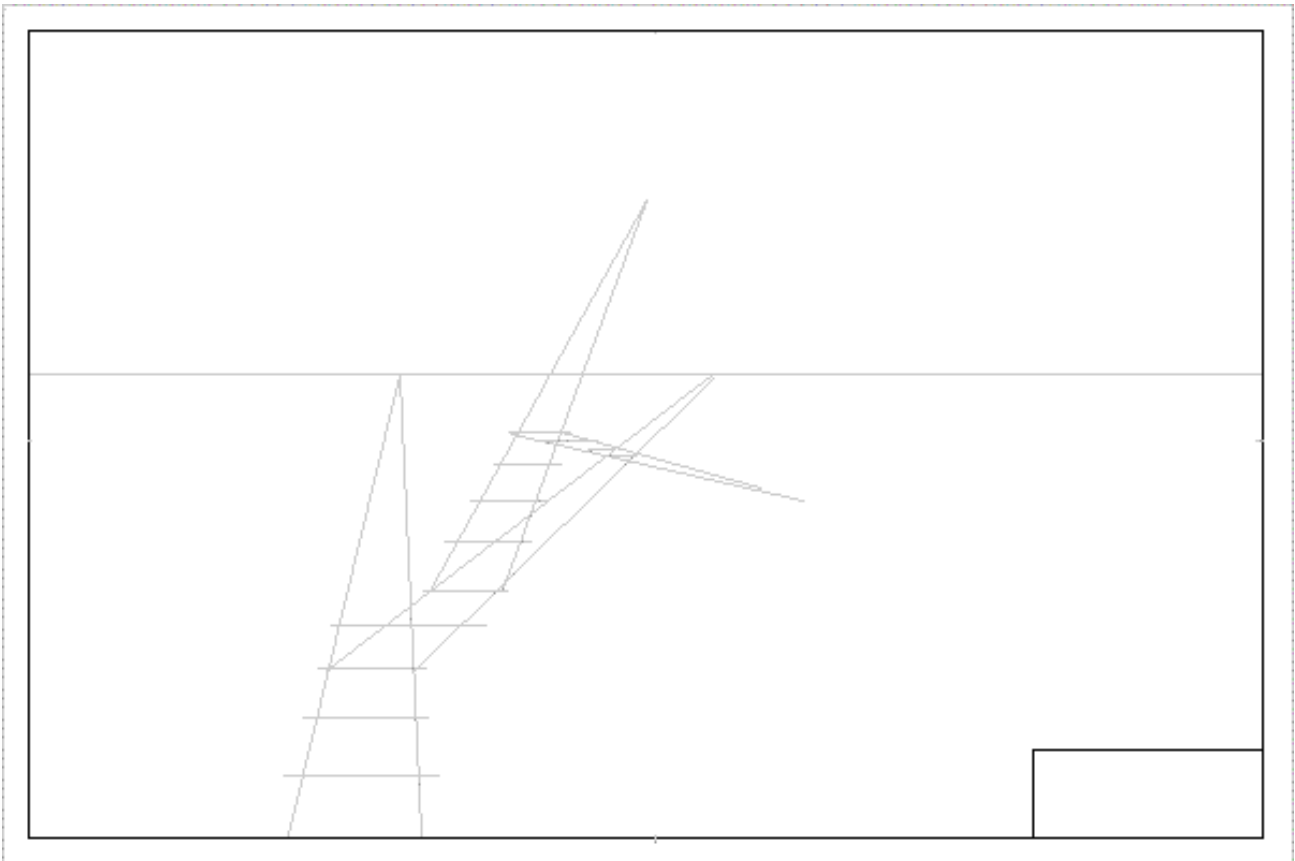

Then go down again ... with a vanishing point now below the line.

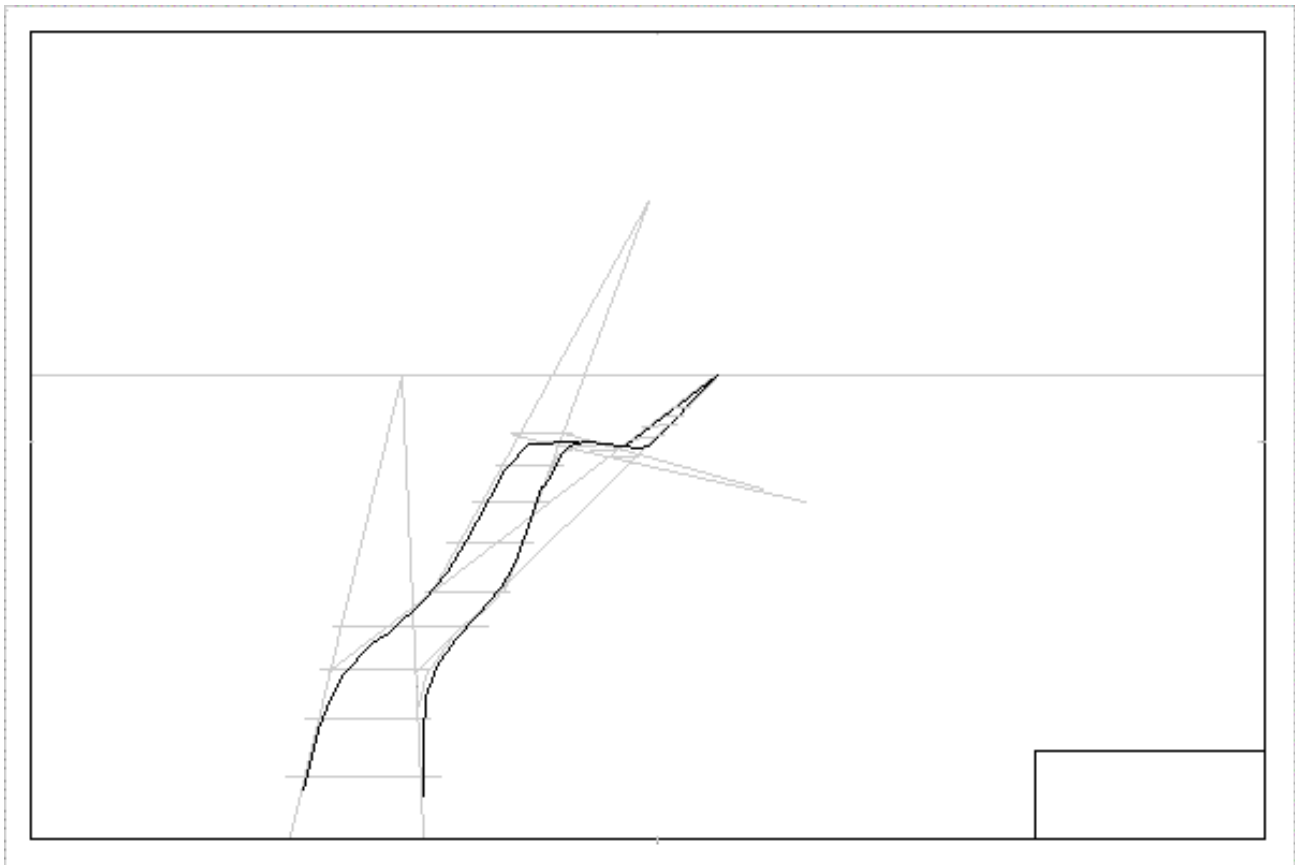

Firm in the lines and explain that every 'regular' object can be placed in space to have its own vanishing point. Here we have merely joined a few together.

Students construct margin and title box on a new page then:

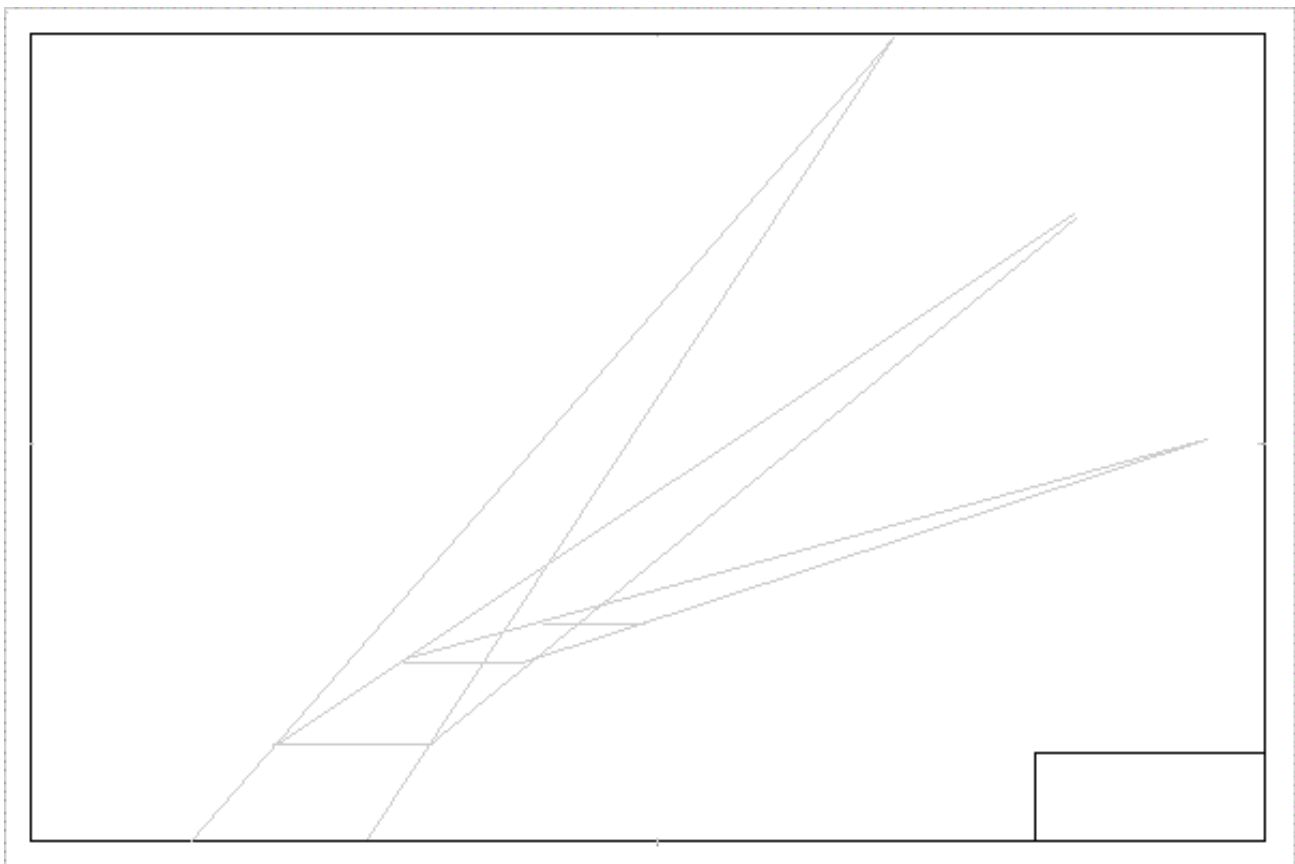

a) In approximate positions, as above, lightly construct a road bending to the right and descending.
...

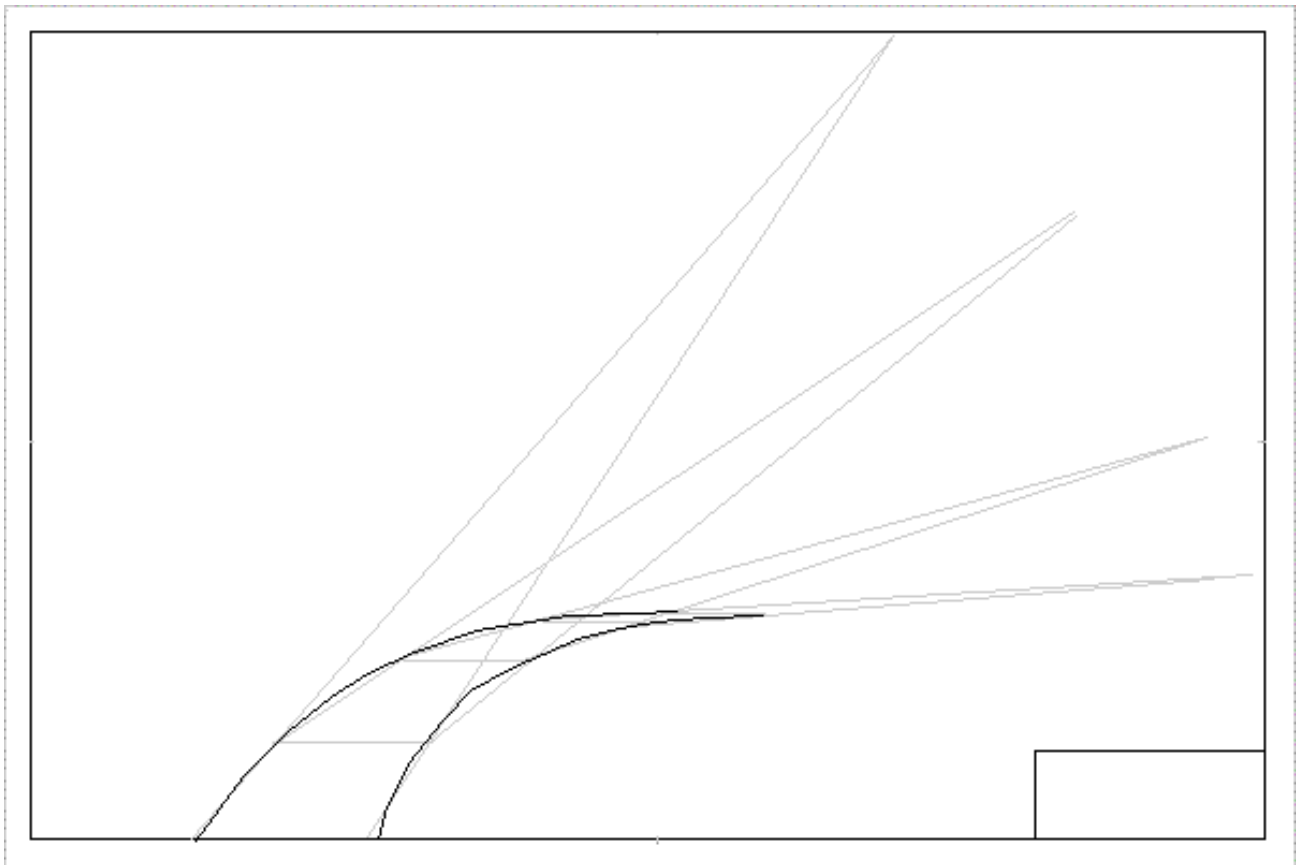

b) Firm in until the curves transcend the horizontal ...

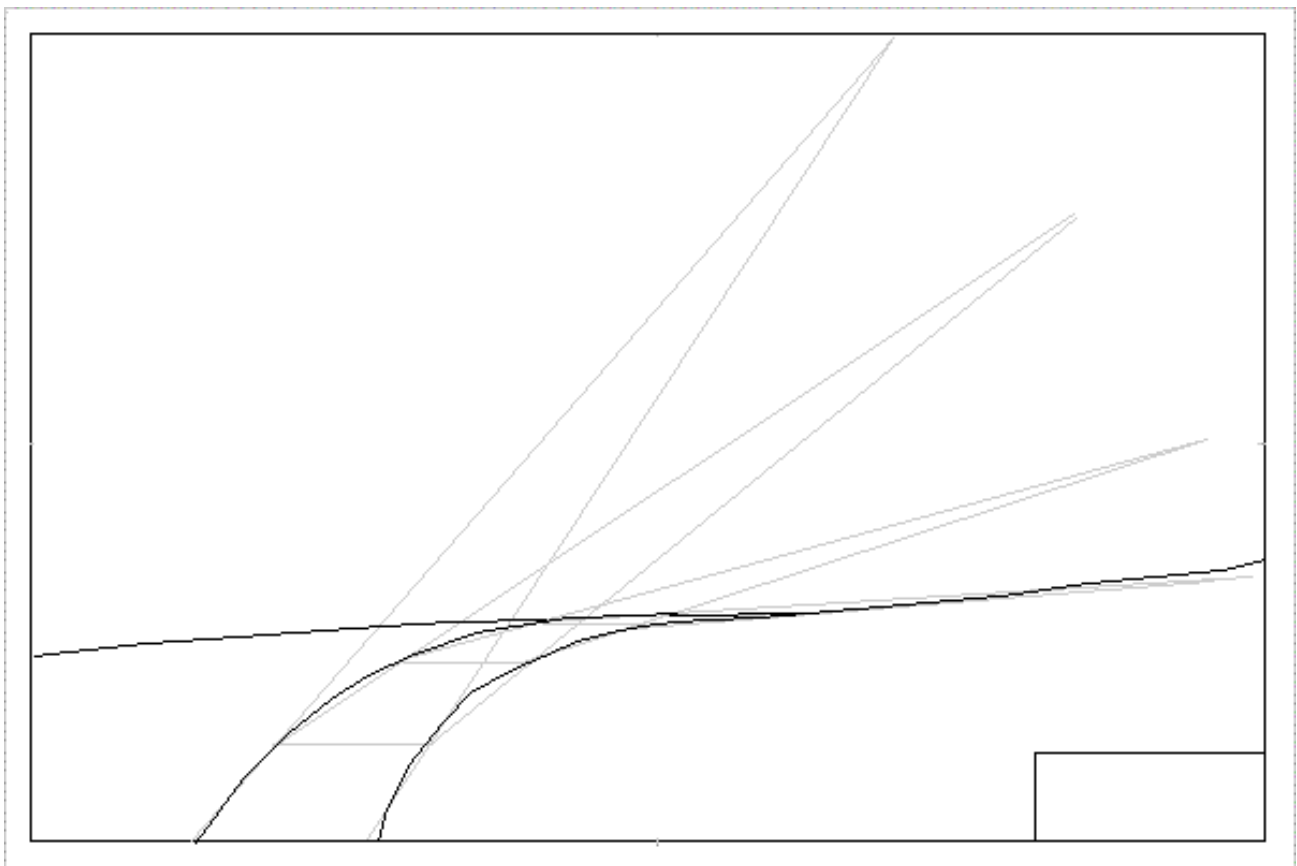

c) and add a nice curving hill.

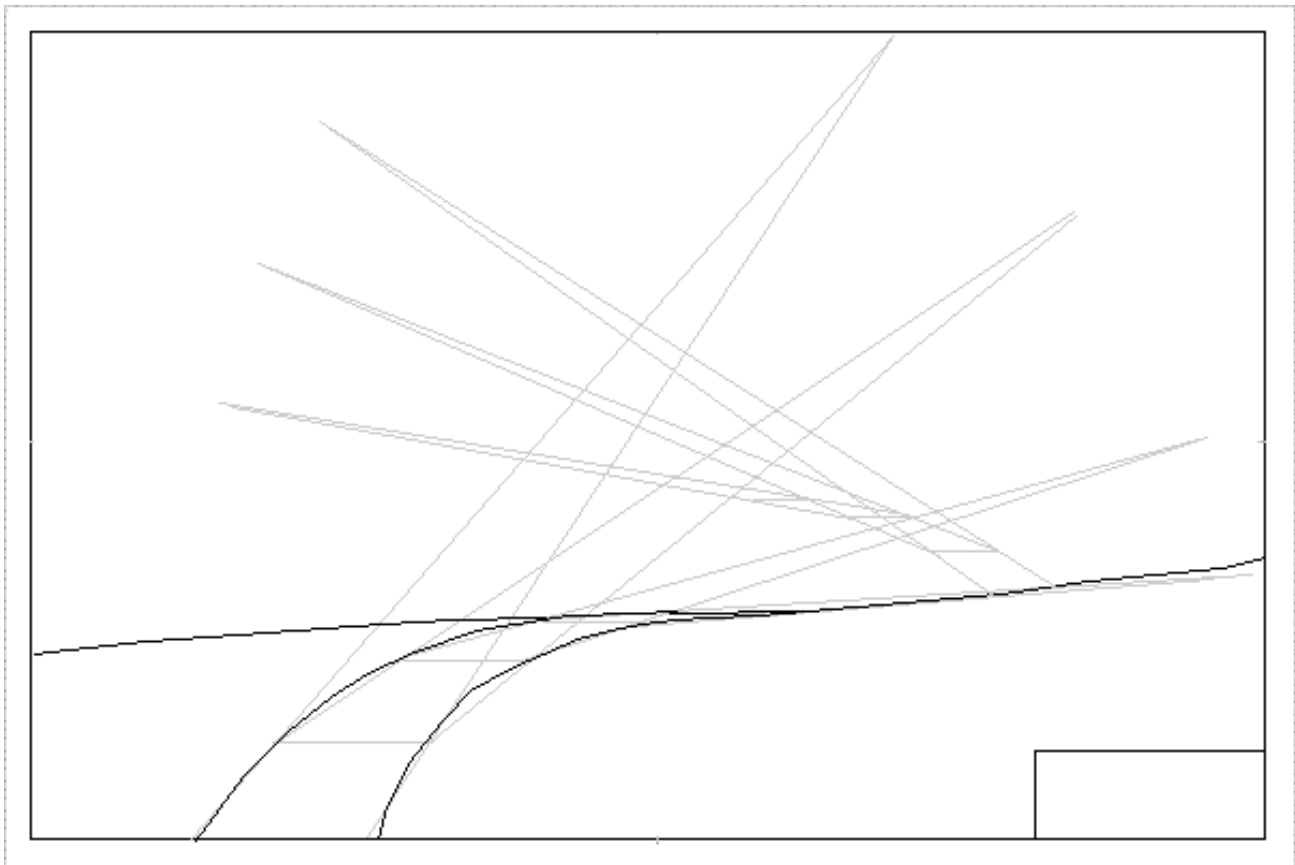

d) Change direction and do the same thing again. Your own 'judgement' should be used to determine the 'new' width of the road. Logically it must be smaller than its width as it disappears over the first hill. Point out that this width will determine just how far the first hill is from the second.

CONTINUED....



[GO TO ... LESSON ELEVEN \(CONT.\)](#)

[lesson menu](#)



LESSON - PERSPECTIVE ELEVEN - ROAD (CONTINUED)

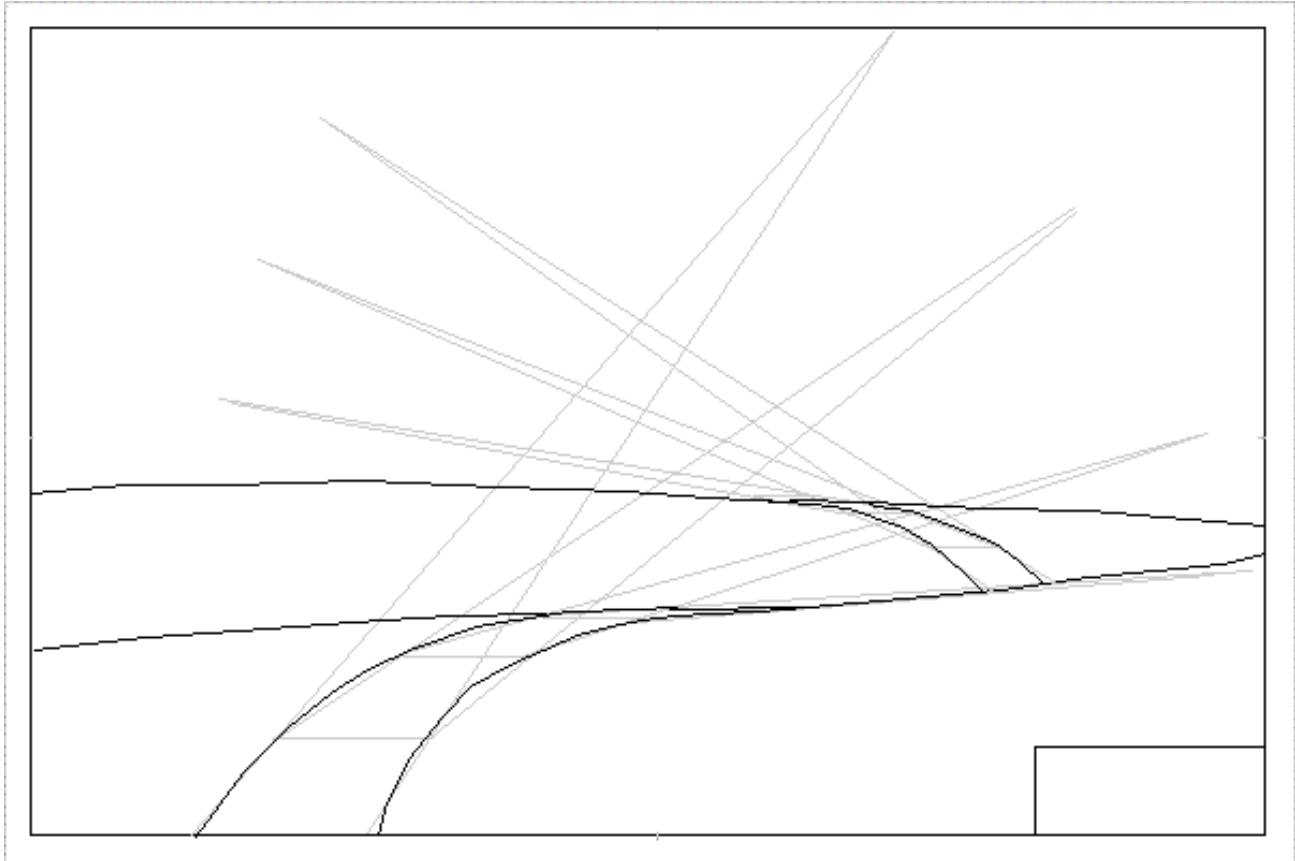

f) Define the second hill as I have, with a nice flowing curve.

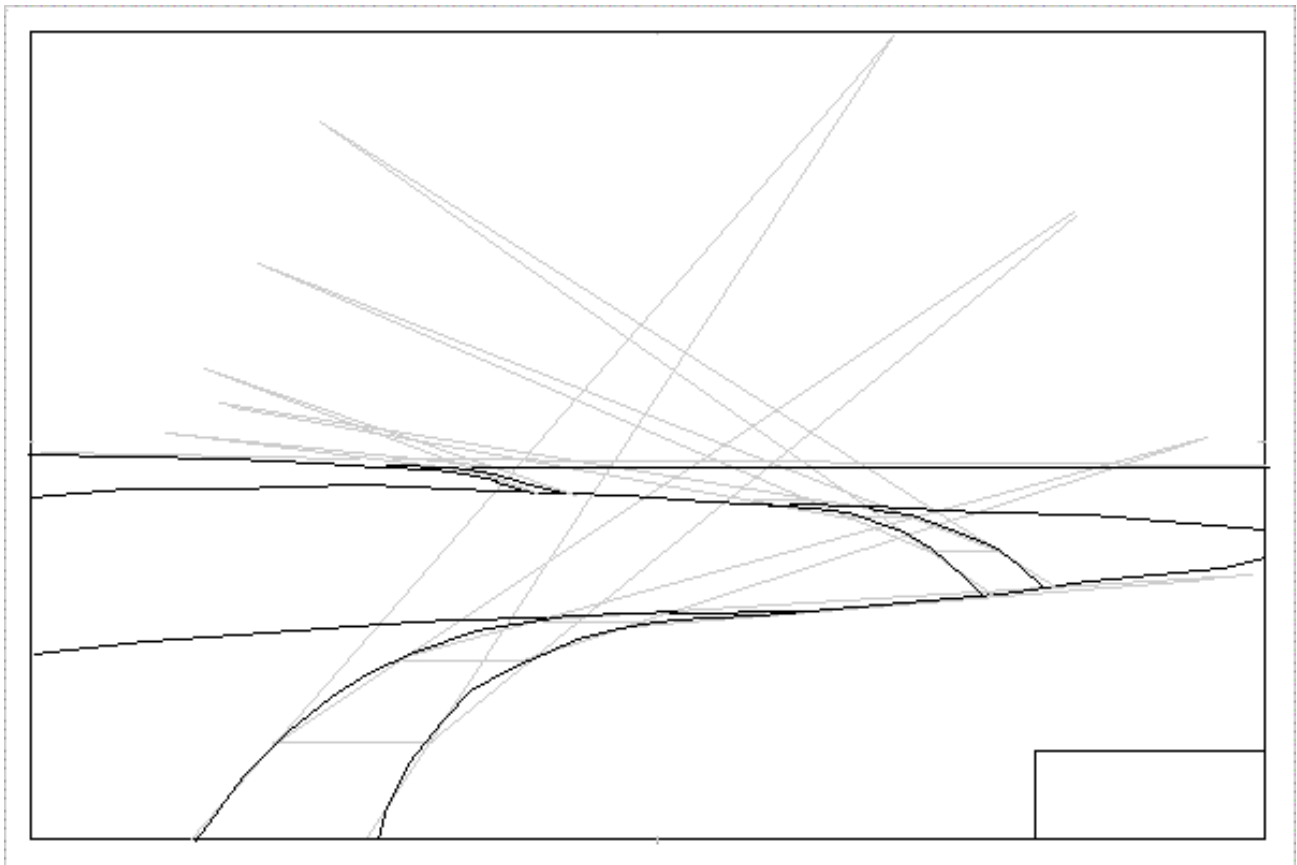

g) Using three more 'vanishing points' (VP's) repeat the exercise; only don't change direction.

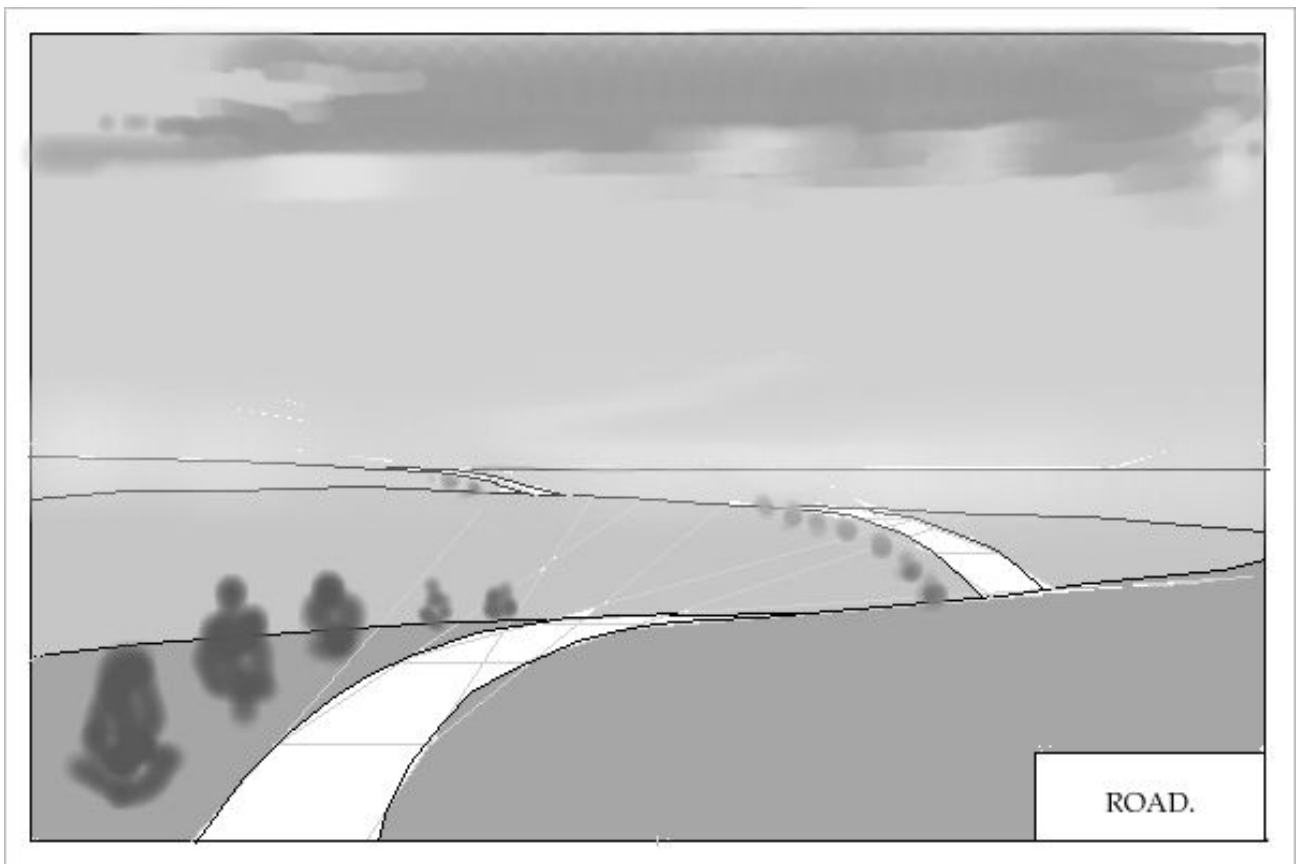

e) Title the drawing and if time permits begin some general shading.

Homework: Add a ploughed field, fences, trees, carts, cars, buildings, etc.



[GO TO ... LESSON TWELVE](#)

[lesson menu](#)



LESSON - TWELVE

Aim: To introduce, explain and use extended vanishing points off the page.

The teacher should print off the following four drawings and hand them out as reference sheets.

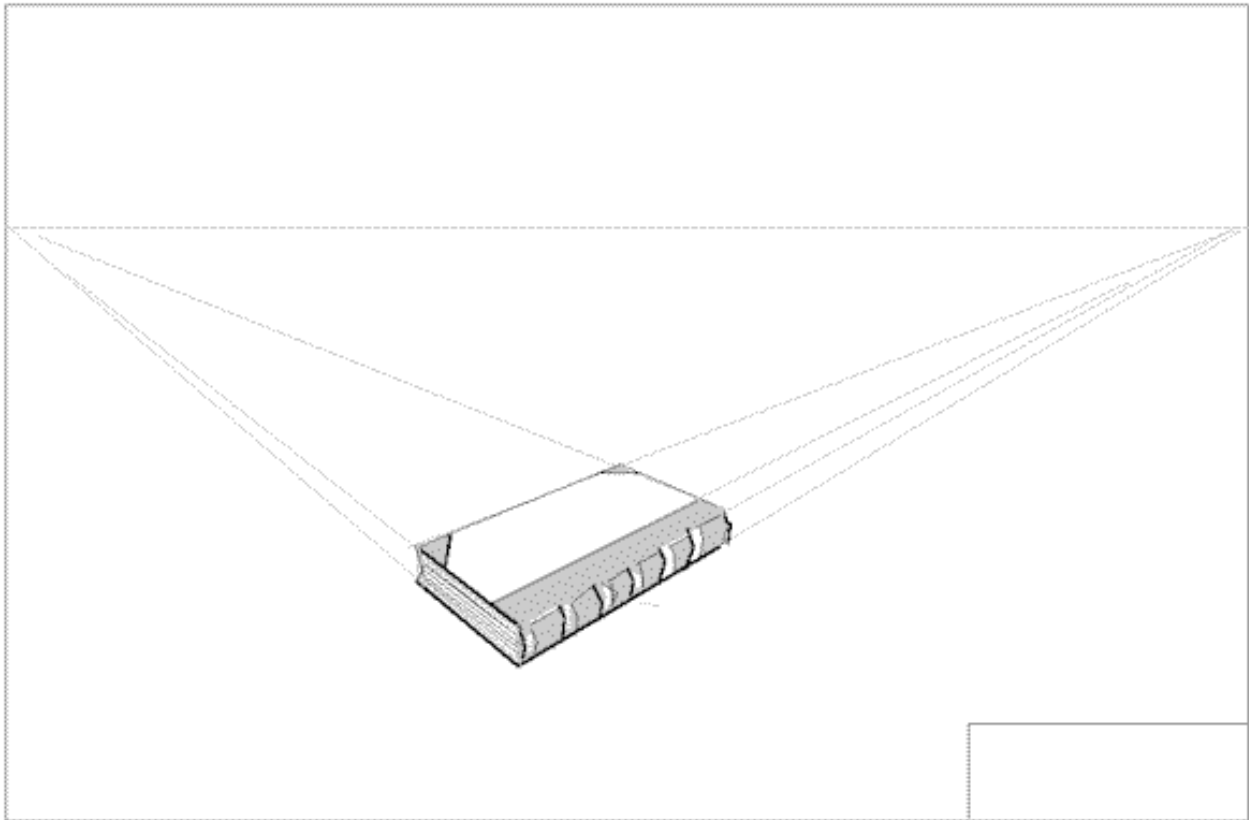

a) This drawing of a book is done as a simple two point perspective using the same method we used on the city buildings in lesson number one.

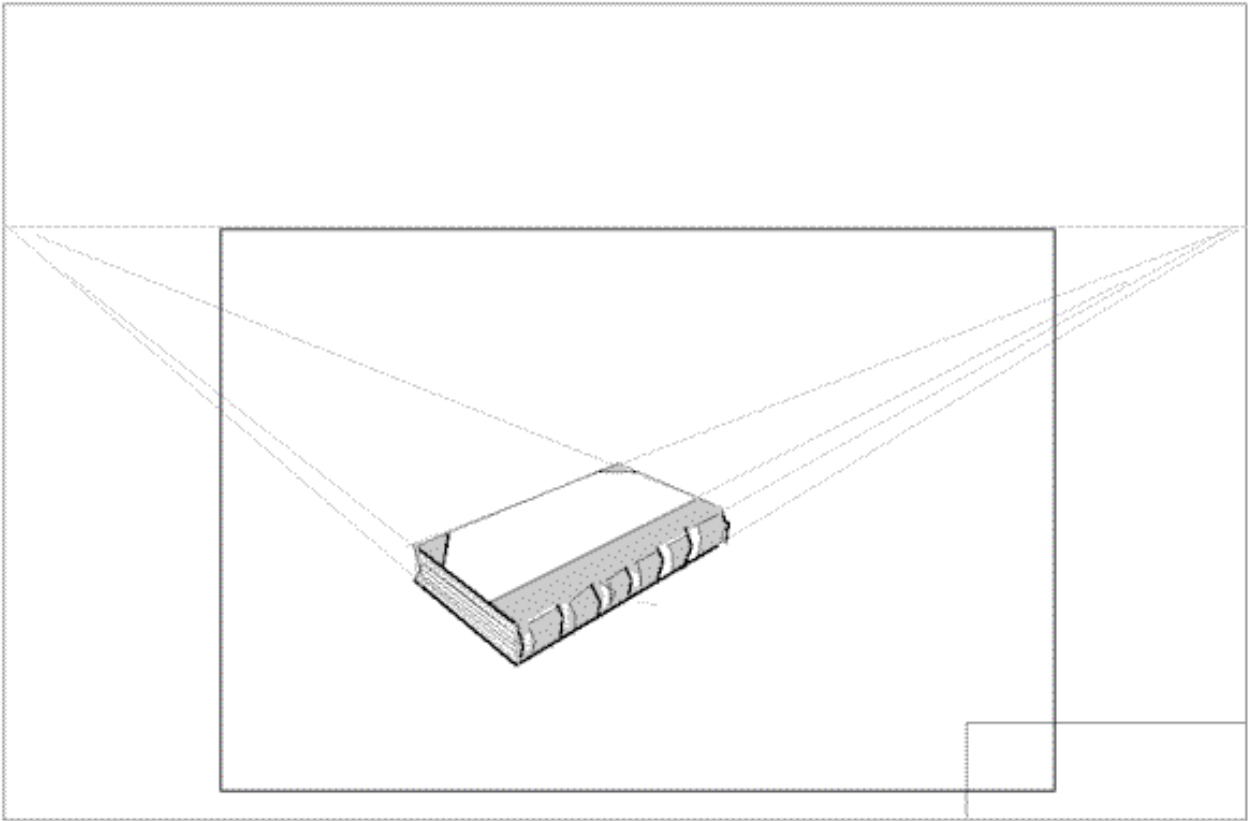

b) What would happen if we zoomed in and cut out a part of our drawing? ...?

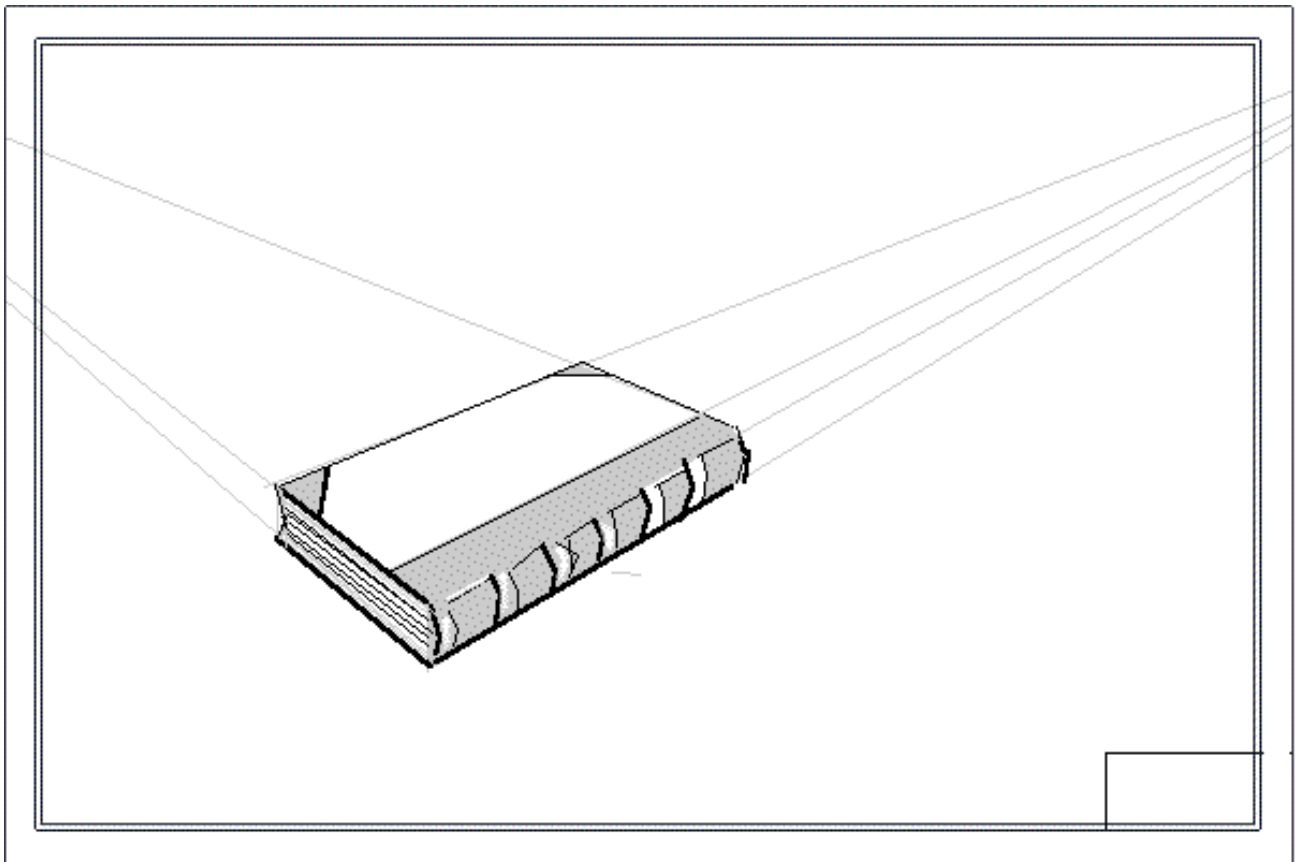

c) Then we made that drawing our full size drawing? Above is the result. The only problem is that our vanishing points have disappeared completely off our page. What then are we to do for this type of drawing?

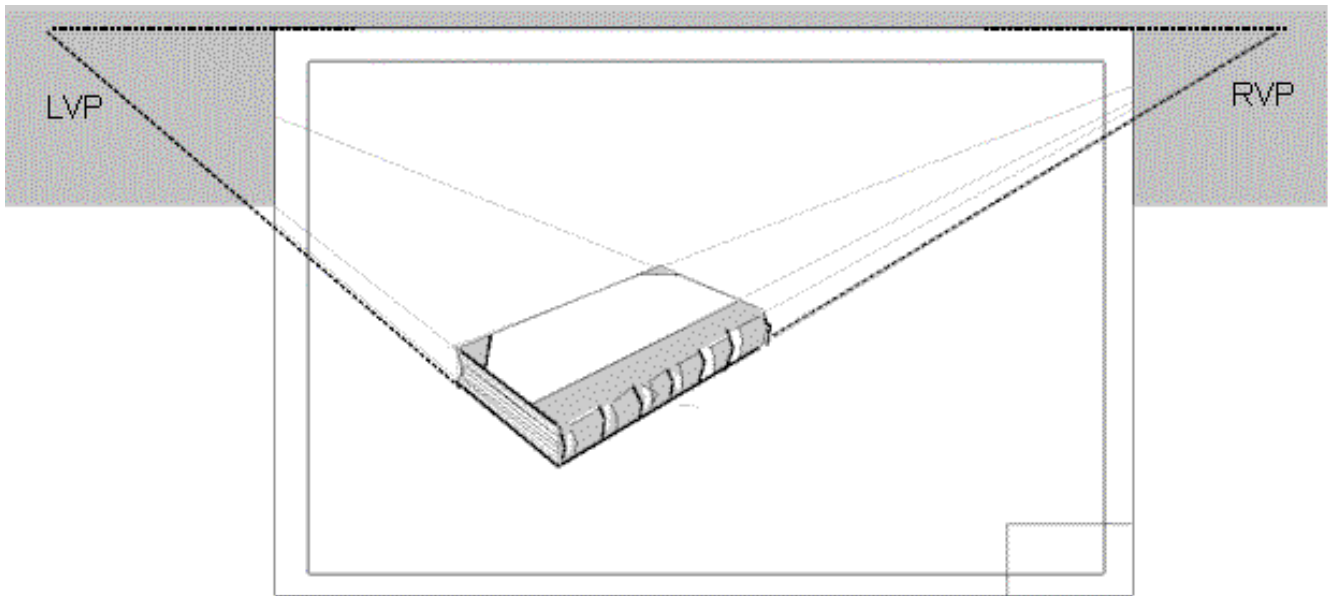

d) We could try and place a much larger piece of paper under our pad and extend our lines as shown above, but more simple is to 'imagine' their position and just draw part of our light lines outwards as if the 'vanishing points' points were actually there.



[GO TO ... TWELVE CONTINUED](#)

[lesson menu](#)



LESSON - TWELVE cont.

Aim: To draw a book using extended vanishing points.

TIME:

Allow 40min

Materials:

The sketch pad,
HB pencil, ruler.

Construct margin and title box then:

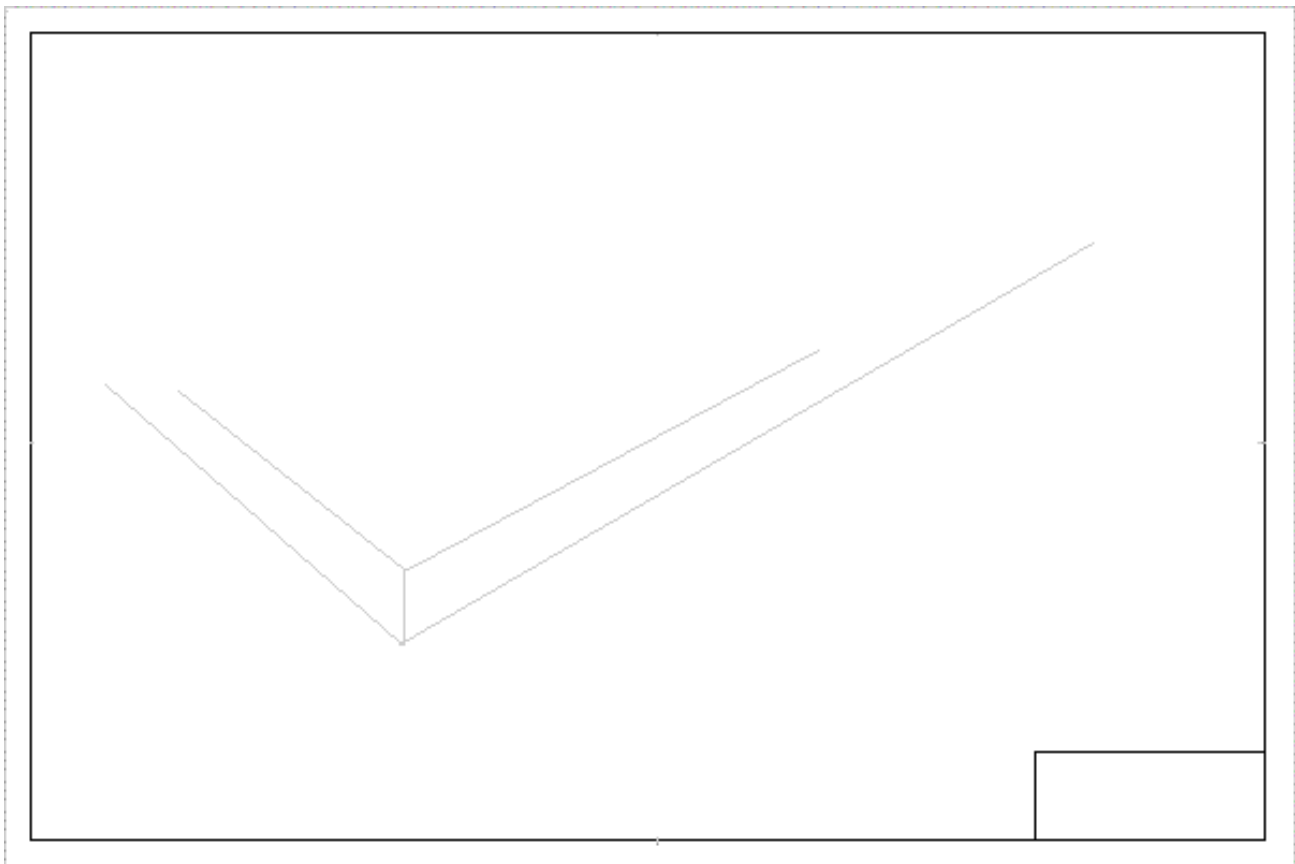

a) As with the example in the previous lesson construct the lines as shown as if there were vanishing points off the page.

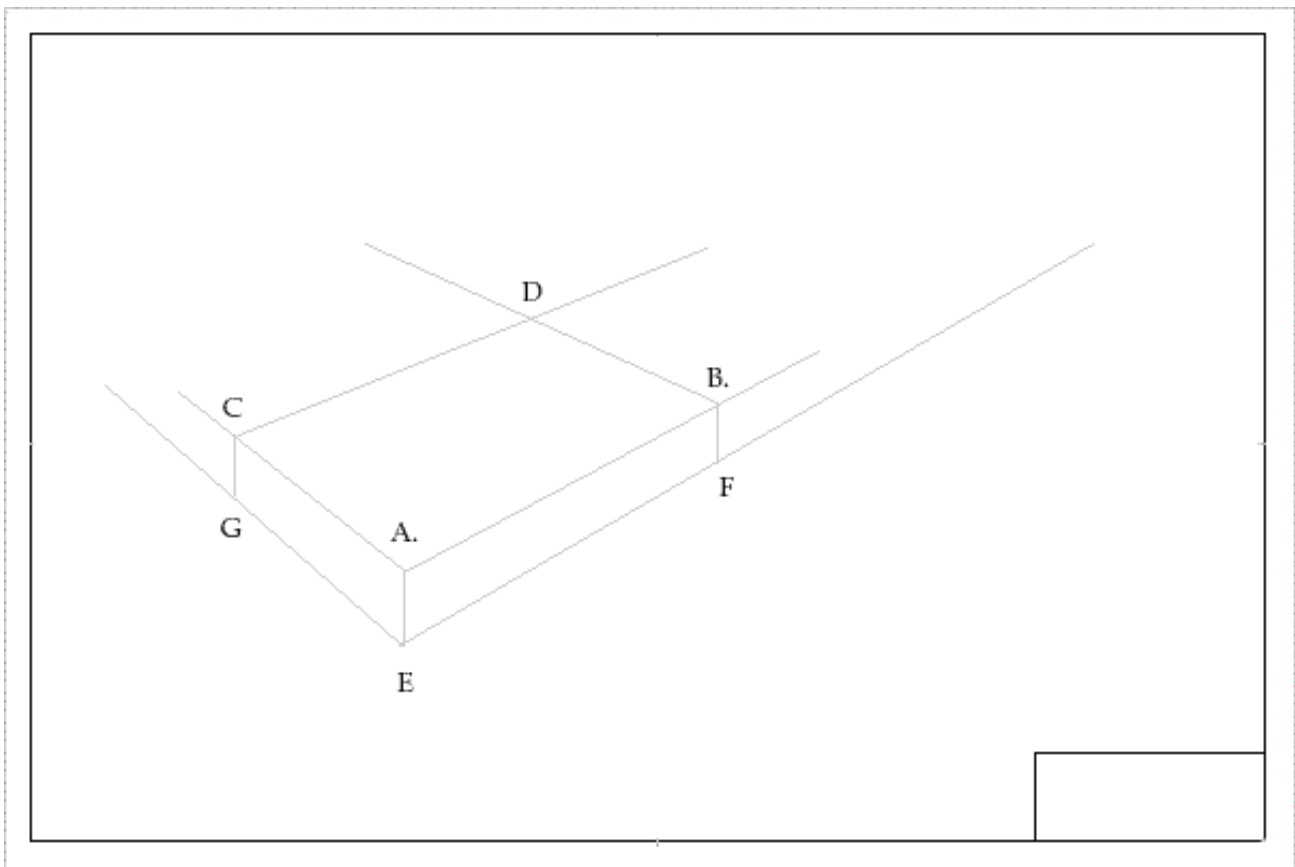

b) Complete the block lightly as it will form the basis of our book. Note CA is larger than DB, AB is larger than CD, AE is larger than BF and GC.

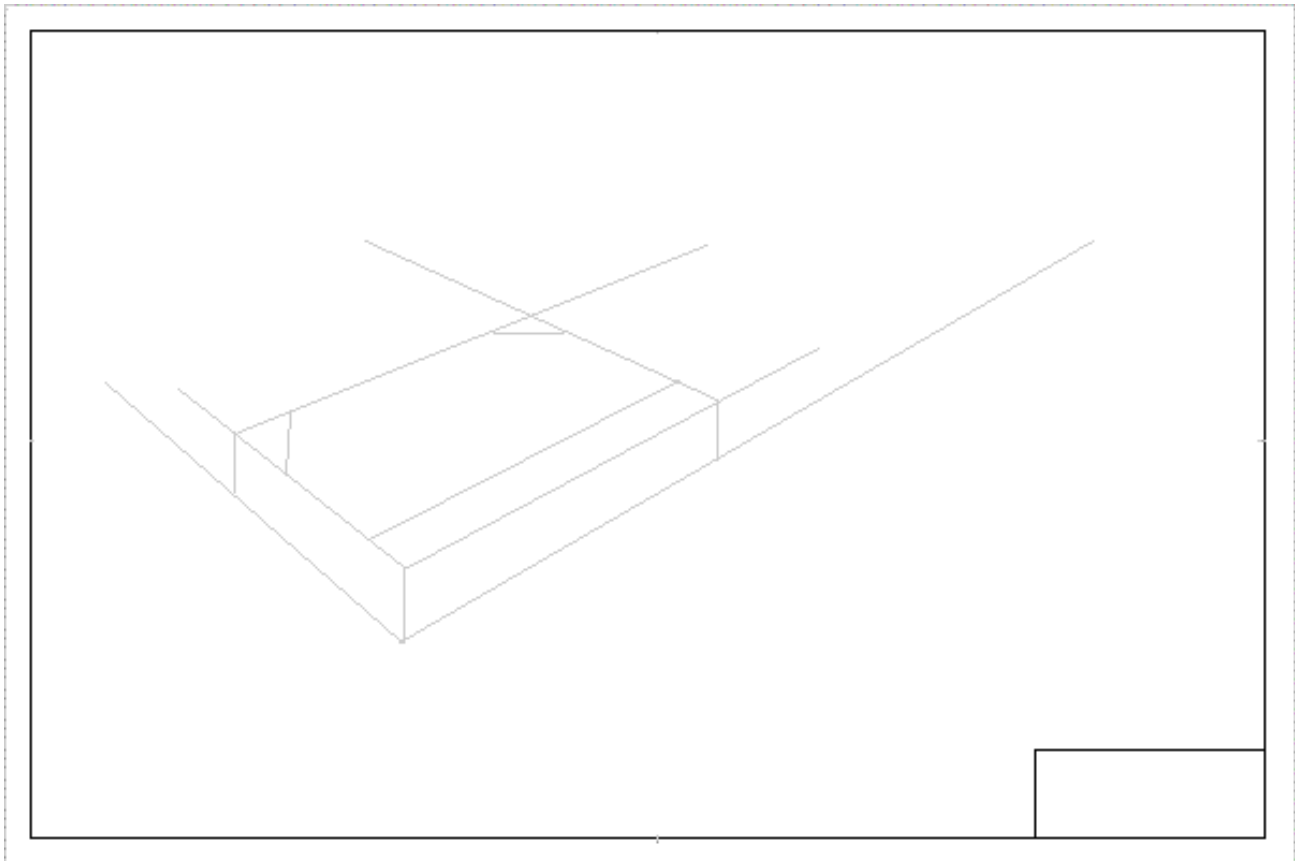

c) Lightly draw in some more main features of the book. It should now look as if it sits on the desk in front of the student.

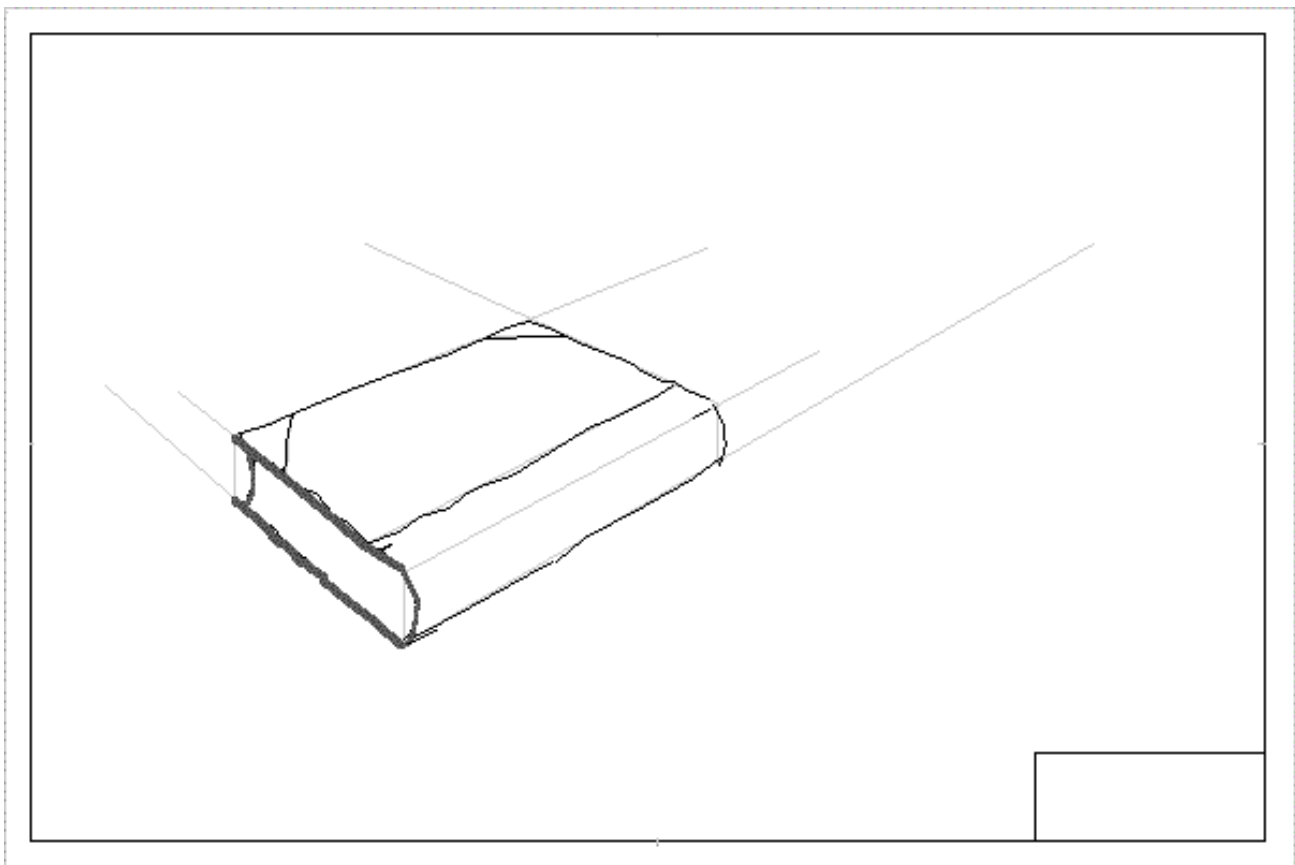

d) Put away the ruler and begin to sketch the book freehand ... using darker lines as shown above.

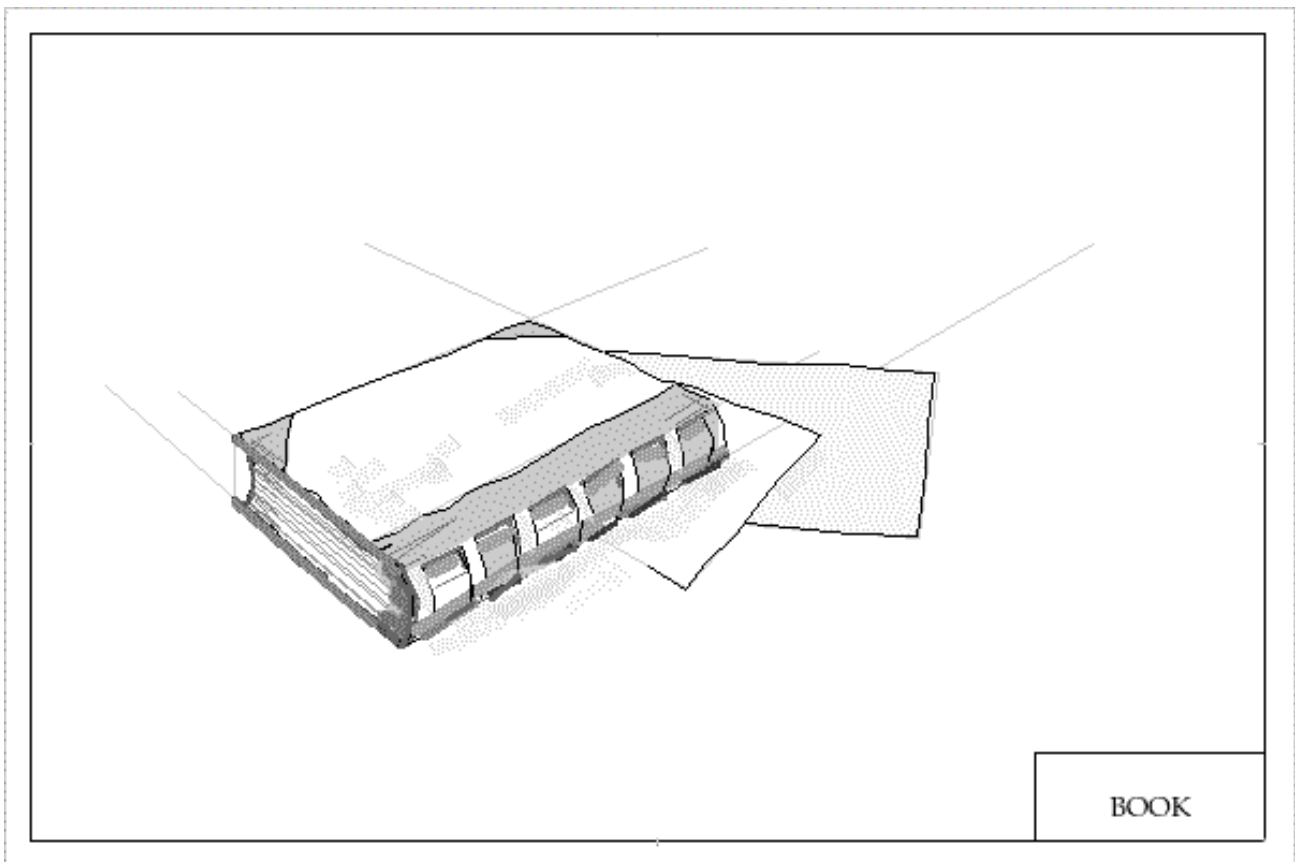

e) Complete the details using shading and your imagination. Add a couple of loose sheets of paper.

HOMEWORK: Complete by adding a pencil.



[GO TO ... PART TWO INTRODUCTION](#)

[lesson menu](#)



LESSON NOTES FOR TEACHERS - PART 2

LEARN HOW TO DRAW

I sometimes refer to an individual as being visually 'literate'. We know the meaning of 'literate' and 'illiterate' regarding reading, comprehension and writing ... which I will refer to as the 'passive' (reading) and 'active' (writing) elements of being literate. The ability to 'read' or understand a drawing is the passive part of visual literacy whereas the ability to actually 'draw' is the active element.



Being 'visually' literate is no less important than being literate in the reading and writing sense. In fact, some may ever agree that 'drawing' should be studied alongside reading and writing. Why? Because before you can write you must learn to draw circles and squares, at least; otherwise how will we make a '3' or '7' ... and 'S' or an 'Z'?

So how does someone become visually literate?

1. **Passive** By learning to recognize things in three dimensions, also learning to read maps and plans etc. in two dimensions. Learning about line, texture, shape and pattern.
2. **Active** By learning to draw just as a writer would learn to compose sentences.

Drawing literacy can best be understood in the absence of language... and its effect can be quite potent. A test might be... 'Using the quickest, simplest drawing and the minimum number of lines you can imagine, draw as economically as you can any of the things on the following list:

A house, caravan, dartboard, pineapple, road, a railway line, a fish a snake, an apple and a pear, a ship, boat, submarine, shark, martini, basketball, helmet, a pair of scissors, sword, spear, banana, cucumber, church, fruit tree, bunch of grapes, traffic lights, ladder, television antenna, lightbulb, scooter, mammoth, the road from your house to the nearest store, comb, fork, paperclip, saucepan, leaf, an anchor, shoe, yoyo, and a button etc.



NO AGE LIMITS: These tests could be given to children as young as five and adults as old as eighty and the results may well determine their 'active visual literacy'. There may sometimes also be little difference in the results. I would test for speed and inventiveness just as you might judge some prose thus. Bear in mind the teacher need not be Leonardo or Rubens to satisfactorily judge the results!

Let's take this active and passive division little further. In what is 'art' today we have the visually semi-literate - in the 'active' sense; they may however, be quite visually literate in the passive sense. Should they be called 'artists' - and would we be as ready to embrace people who called themselves writers if they attempted to write of their experiences neglecting any structure? I don't think so; and some of my own writing proves just that!

Is any of this important to the human species? The children I tested seemed to think so.... maybe

such tests need to be given to some of our national art critics... I made a comment once ... when we talk of educating our children in 'the basics' we should mean the basics of reading, drawing, writing ... and perhaps maths; but then I may be a little biased.

Imagine beginning every art class with 'OK children, open your sketch pads and do two quick sketches; a coconut and a saw. You have three minutes..... then we will be finishing off the drawing we started last week.

Well this is exactly what we shall now be doing with our drawing course.

Time- Lessons separated into approx 40 min segments.

Homestudy - 10 to 20 minutes per lesson - set work proposals suggested at end of each lesson.

Materials;

30x45cms or 12"x18" standard cartridge paper (thick, white, plain) sketchpad.
2H, HB and 4B pencils
eraser

New General lesson structure;

5 min. short drawing test (3min. for test 2min hold up and look at results)

5 min. revision and homework assessment.

5 min new page, draw margin and add title (bottom rh corner)

20 min demo and child practical drawing

5min summary and suggested homework.



[GO TO ... FIRST LESSON](#)

[lesson menu](#)

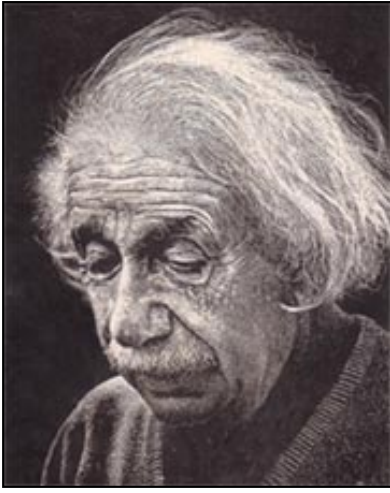

PART 2: LESSON 1 - SETTING UP

TIME:

Allow 40min

Aim:

To establish a new format for freehand lessons and to introduce the 'quick sketch test' to enforce observation and awareness of common day things.

Materials:

The sketch pad, HB and 4B pencil, eraser

Without using the ruler (or any other straight edge) prepare the page with margin and add the freehand boxes as shown.

a) The student should draw the margin lightly (HB pencil), using short lines and when satisfied, firm it in. Allow a good ten minutes for this as some students will be concerned to produce lines of great excellence. This will not be possible at this stage and they could be told to expect as much. The student should be encouraged to keep turning the sketch pad to suit their hand movement, and to use the page edges as guides.



b) When the student is satisfied with the light lines they can be 'firmed in' thus (again using short,

comfortable lines):

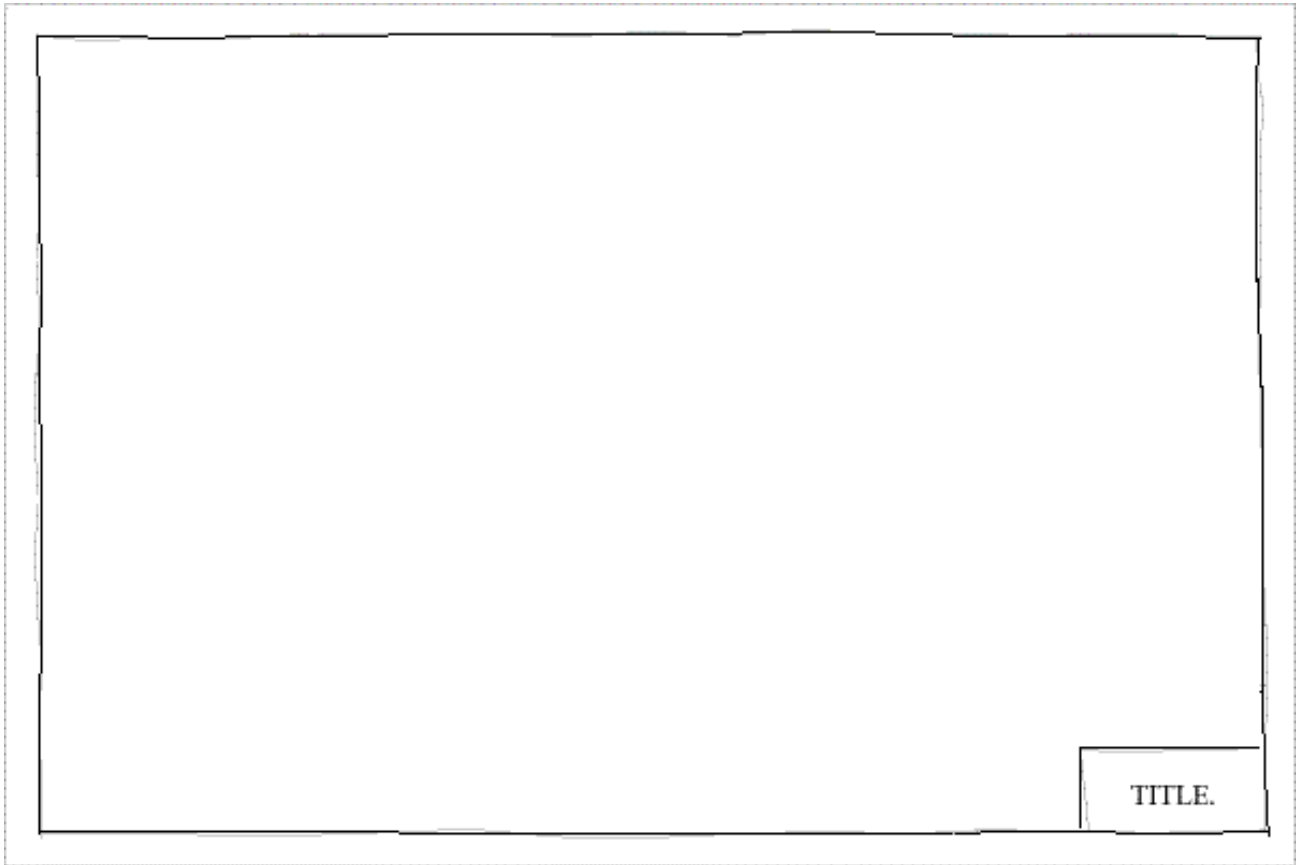

c) Without using a ruler divide the page into quarters using light lines as shown below.

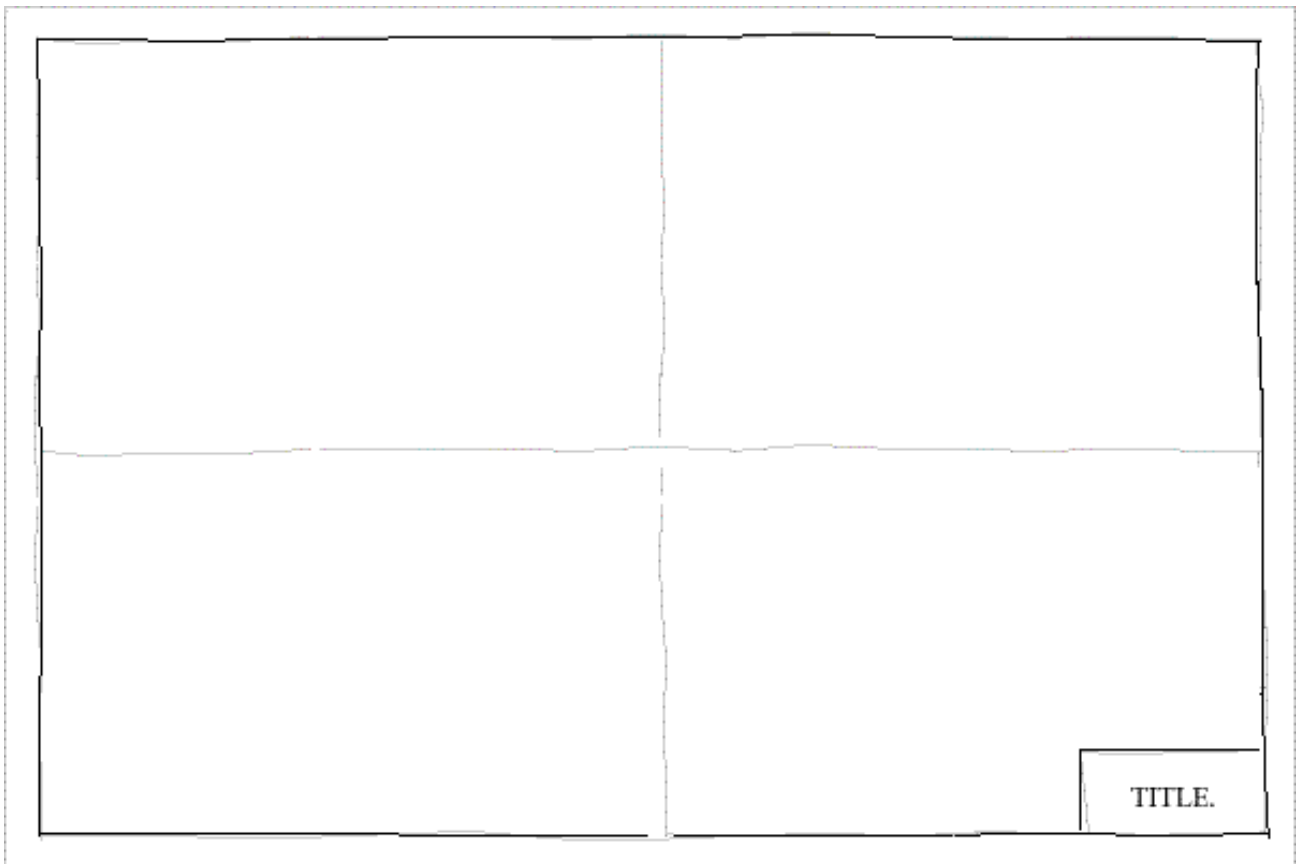

d) Divide again.

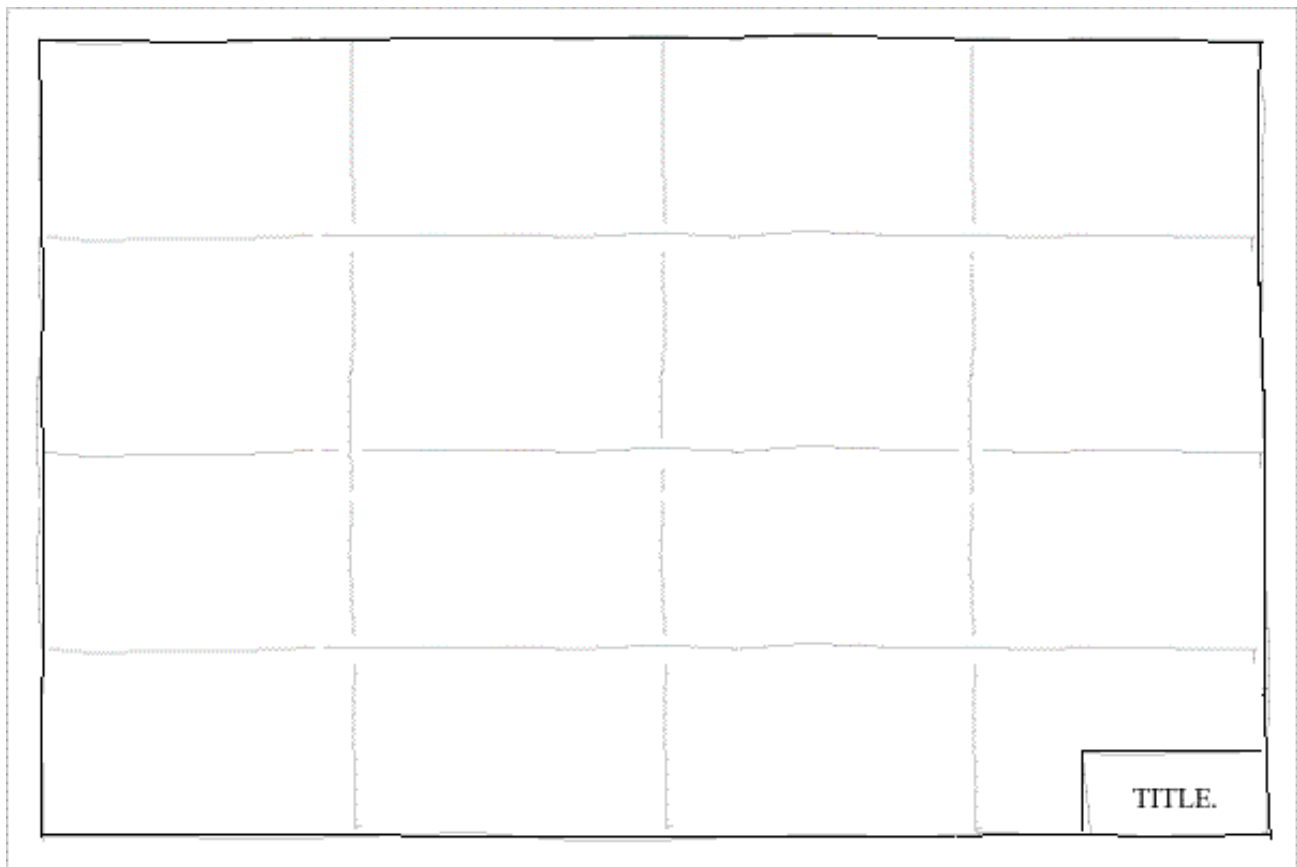

e) And yet again as shown.

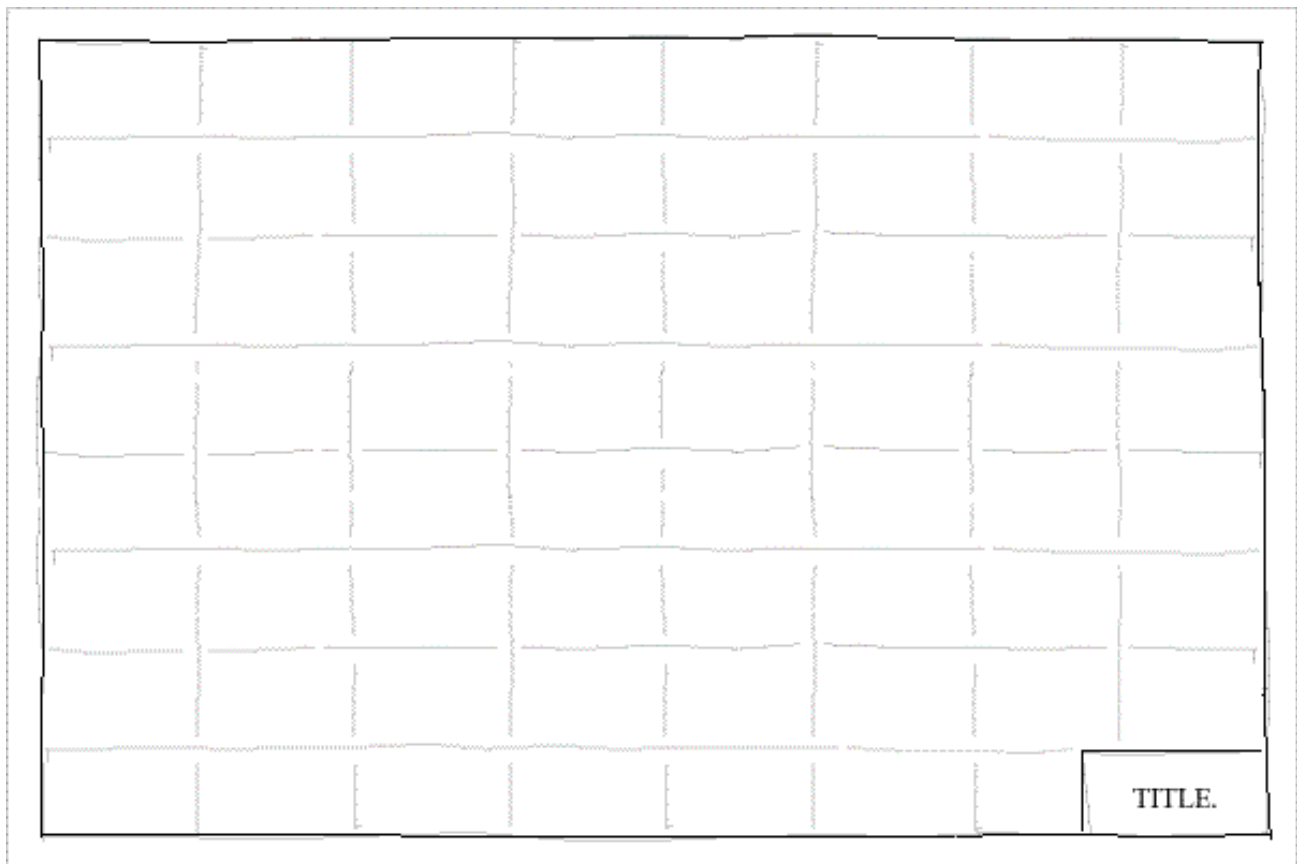

f) And again, so now you have 64 spaces (ignoring the title box).

TWO QUICK SKETCHES

Allow two minutes at the beginning of each lesson for this next exercise.

In the first two little spaces along the top the student is asked to draw their simplest representation of any two commonday objects of choice. They may make them up or use any of the examples listed

on the previous page. It is recommended that the research (practice) for these be set as homework. Then the student will be forewarned and prepared - although any lack of preparation can lead to interesting times ...

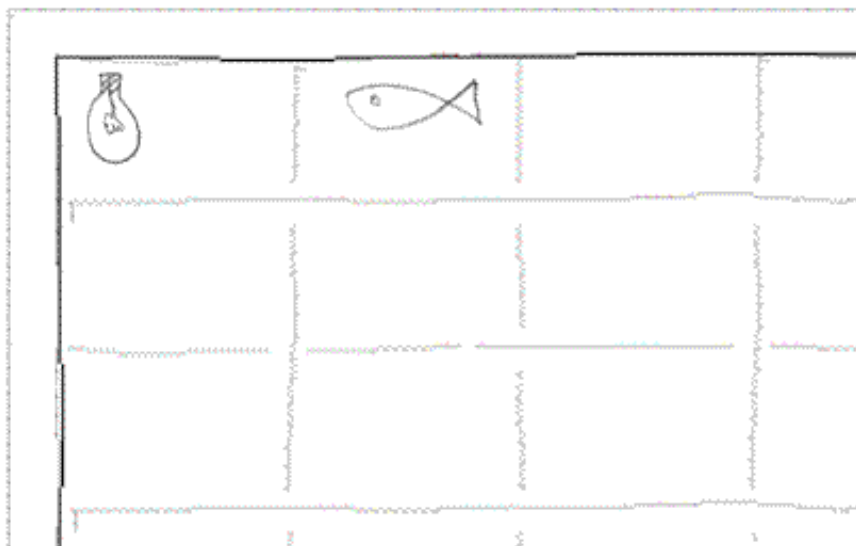

At the completion of the time allowed for this task (can be shortened for future lessons) the student will ask his or her neighbour to guess and write down the names of the articles or objects. If they match the drawings they should remain unidentified (no need for any notation). If not recognized the student should identify them as shown below. The Teacher will be the final arbiter. Be kind!

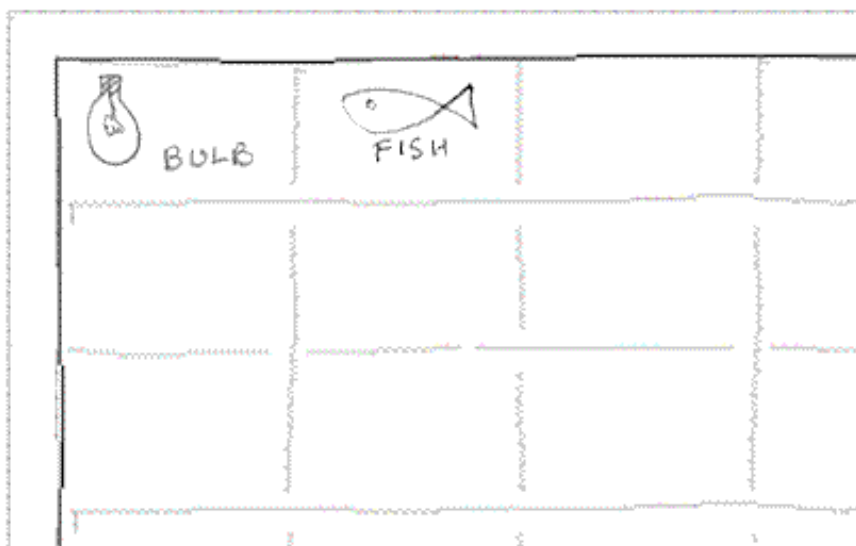

This whole exercise should be treated as fun as the teacher will find the students serious enough and naturally competitive. Do not ridicule any effort yet be constructive where necessary. Praise the good and display the brilliant for the rest of the class to see. Simplicity and effectiveness are the keys. In the example above try and guess what the two unnamed objects are? You will see they are drawn with the maximum economy of line. That what we want from the student.

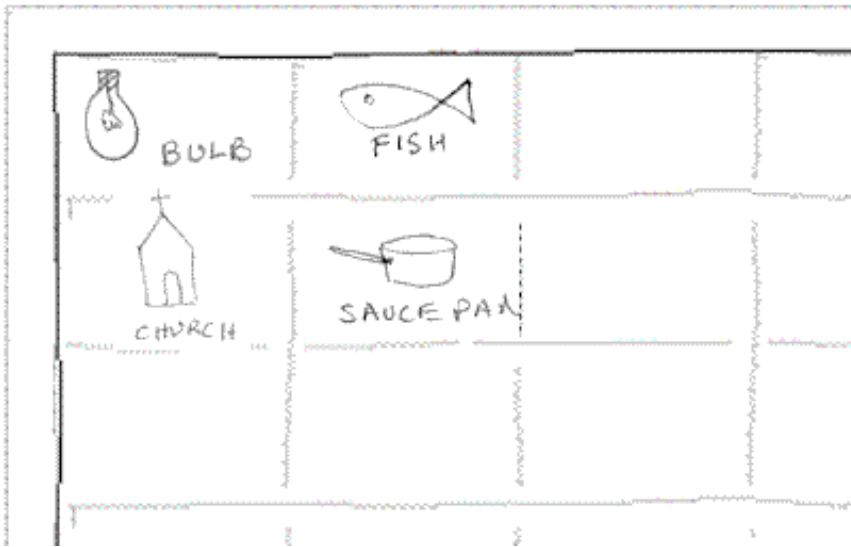

The possibilities for set homework are manifold in these new set of lessons. Page preparation, common object research, completing drawings begun in class etc. Judge the pace according to student level and class performance.

If time remains in the 40min period the student could begin preparing future pages (light lines) with title boxes and freehand borders.



[GO TO ... LESSON TWO](#)

[lesson menu](#)

PART 2: LESSON 2 - SHADING

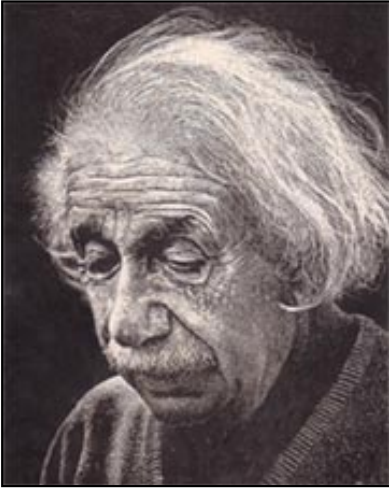

TIME: Allow 40min

Aim: To begin the lesson on shading. This will encompass cross-hatching and other useful methods as well as noting the theory of shading generally.

Materials: The sketch pad, HB and 4B pencil, eraser

Allow five minutes to for the quick sketch test. Two minutes to do and three to mark. Swap, display and title if necessary.

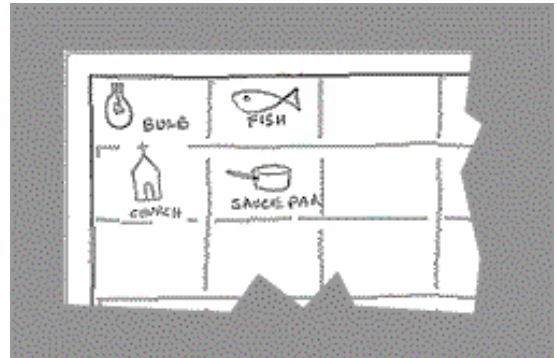

CUPS a) Without using the ruler (or any other straight edge) prepare the page with margin and title boxes then: Make a light freehand sketch of a cup as shown below, then repeat this until four similar cups are made

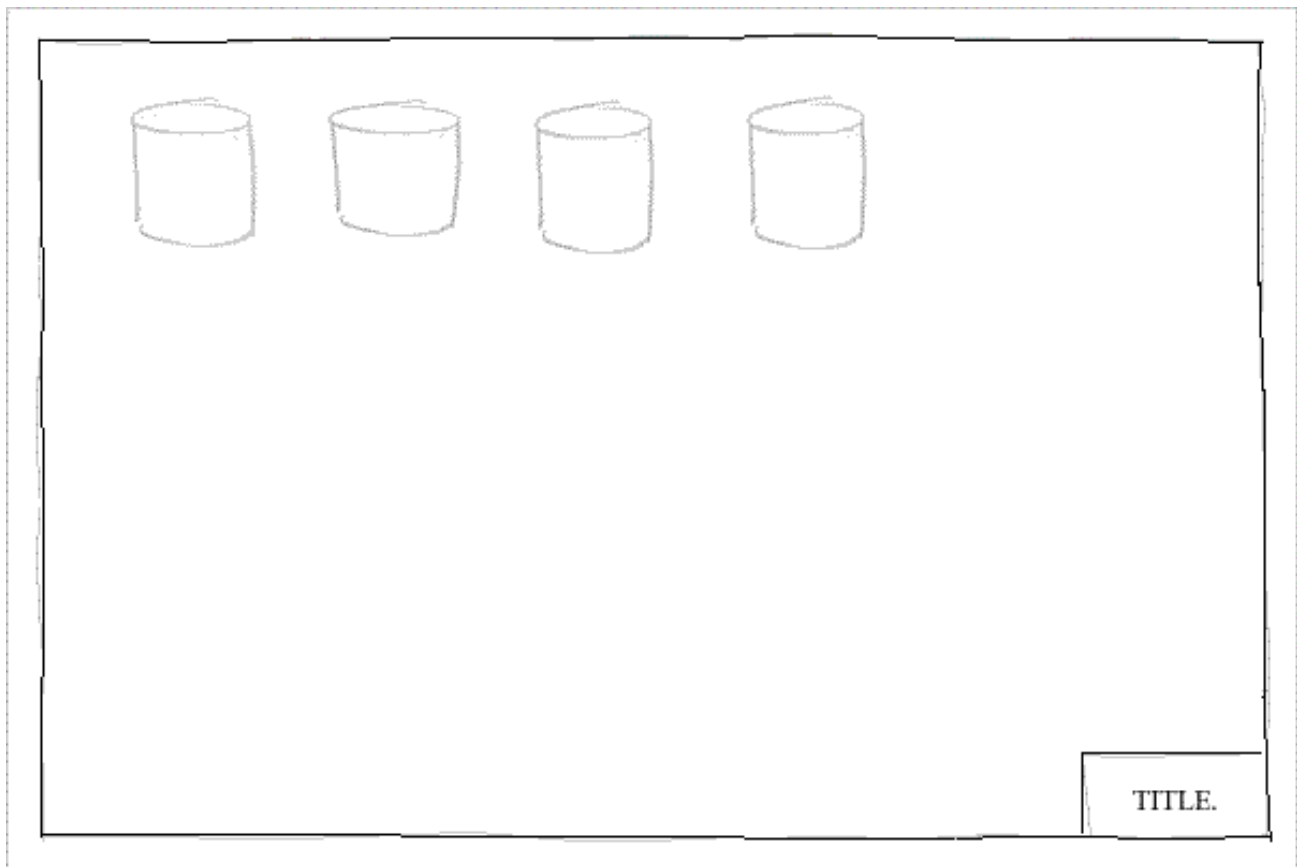

b) Using short strokes firm in cups.

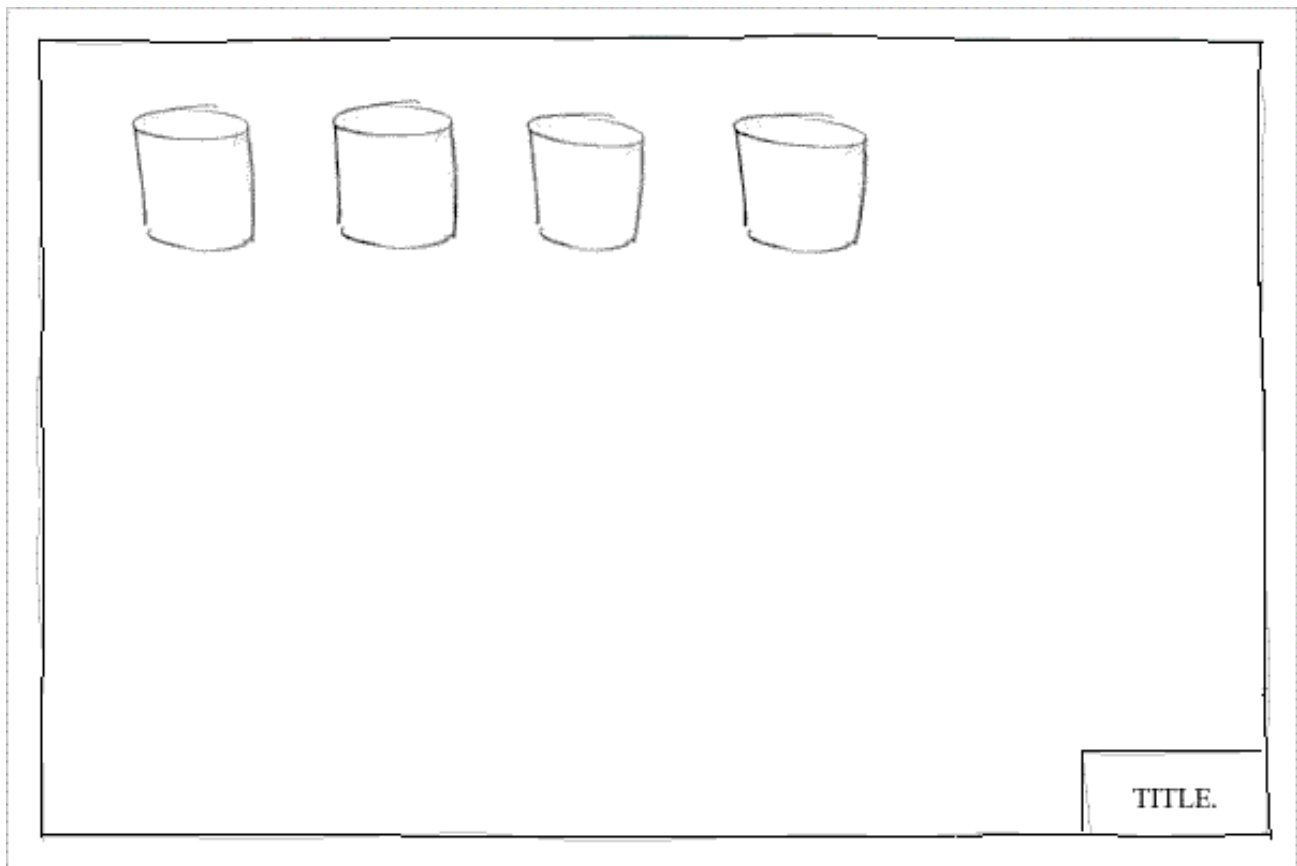

c) Use the 4B pencil and medium pressure 'hatch' a series of parallel sloping lines as shown.

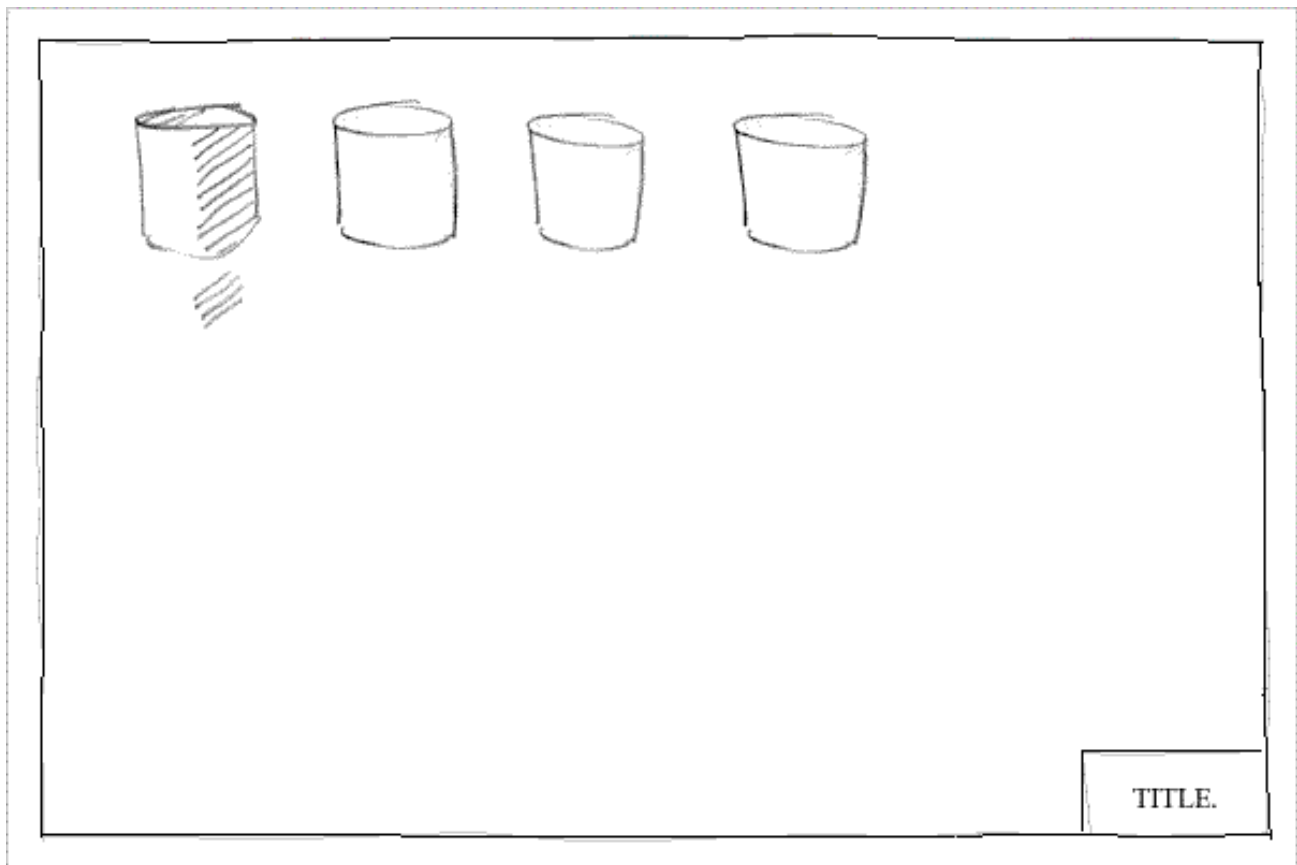

d) Do the same, though with shorter lines, in the other direction. Next use some vertical lines and lastly some horizontal. This method of shading is called cross-hatching and is useful for quick renditions.

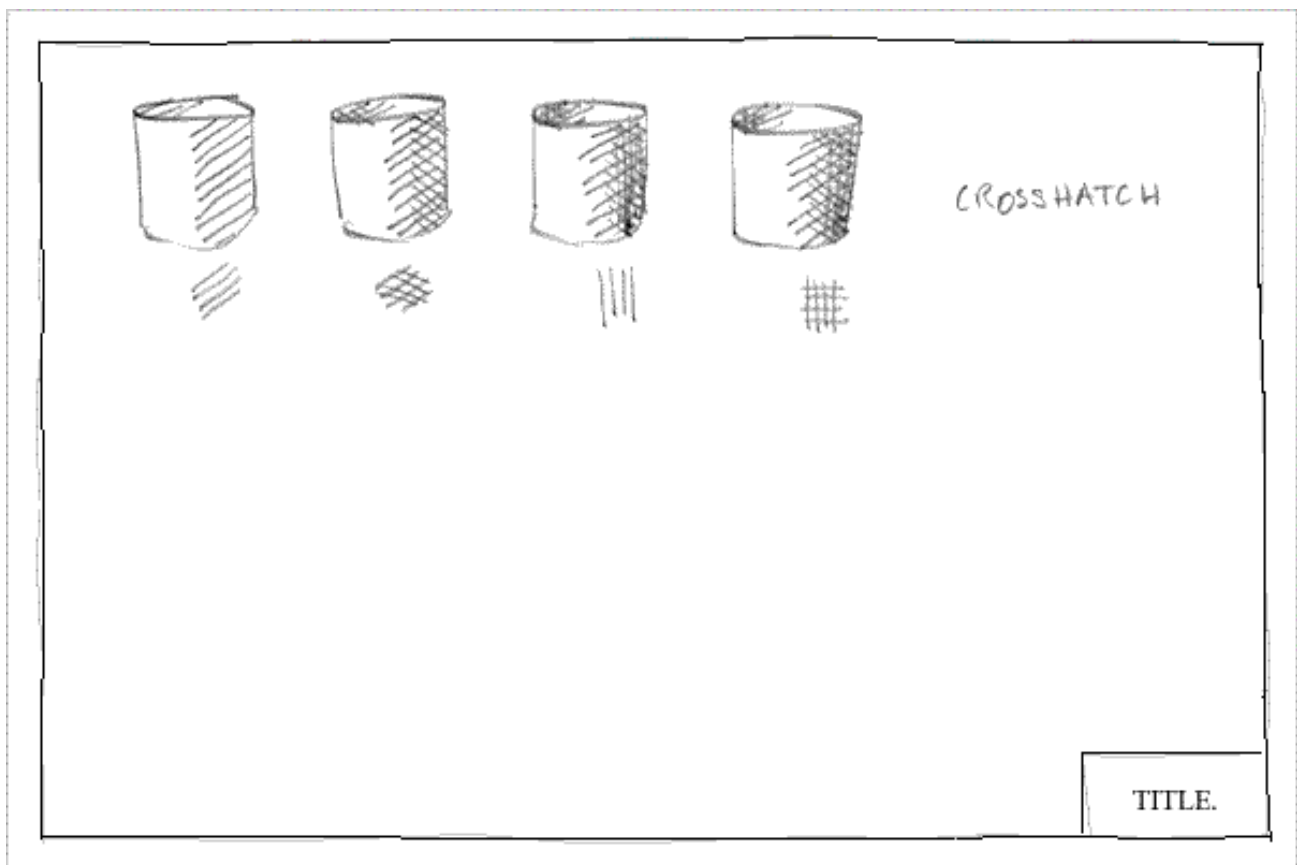

e) Make another row of four cups.

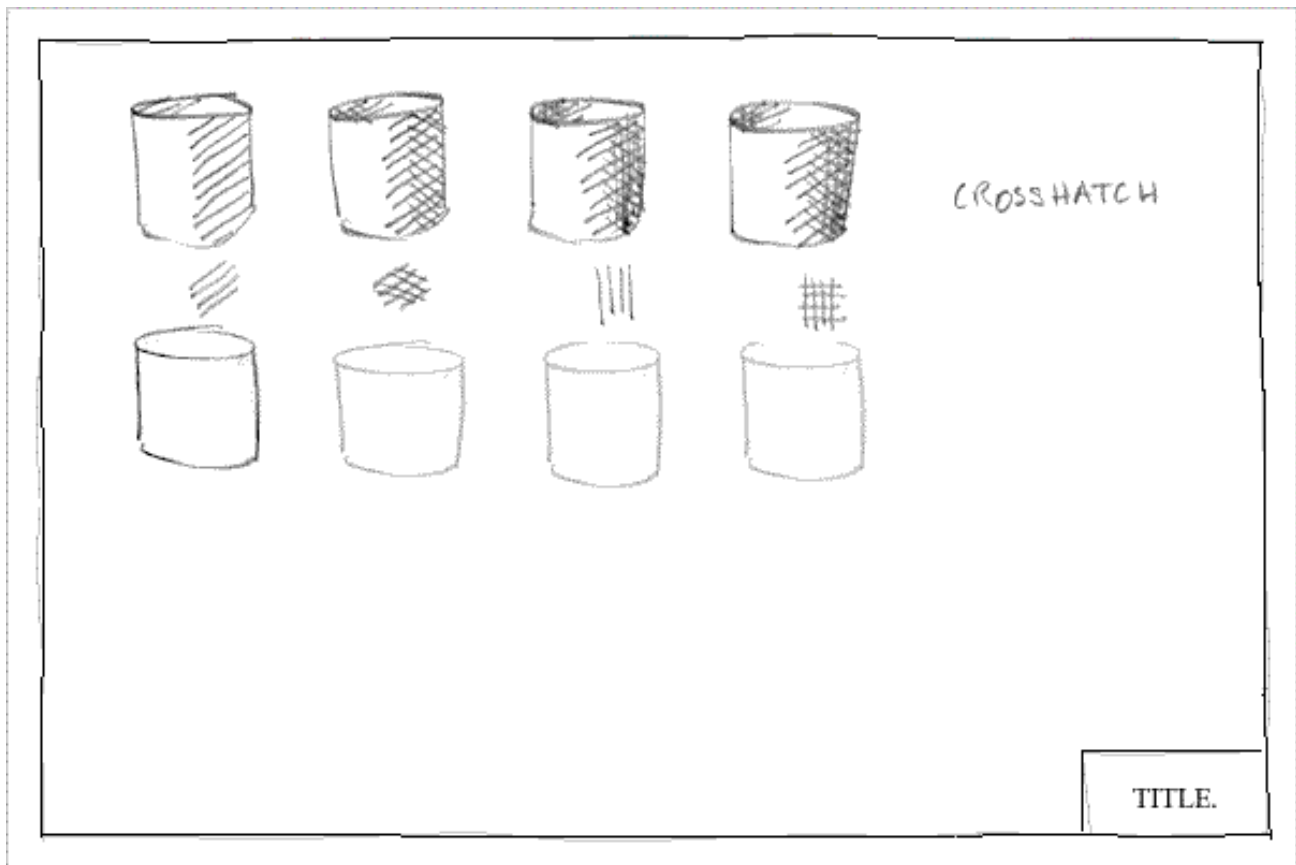

f) This time we will use a 'figure 8' as our shading method. You could use an 'O' or an 'S'. Use your 4B pencil with a 'light weight' or light pressure and draw a series of '8's' as shown. As you near the darker edge of the cup the 8s can 'overlap' and get a little darker. Don't forget the top left 'mouth' of the cup as it too will need to be shaded.

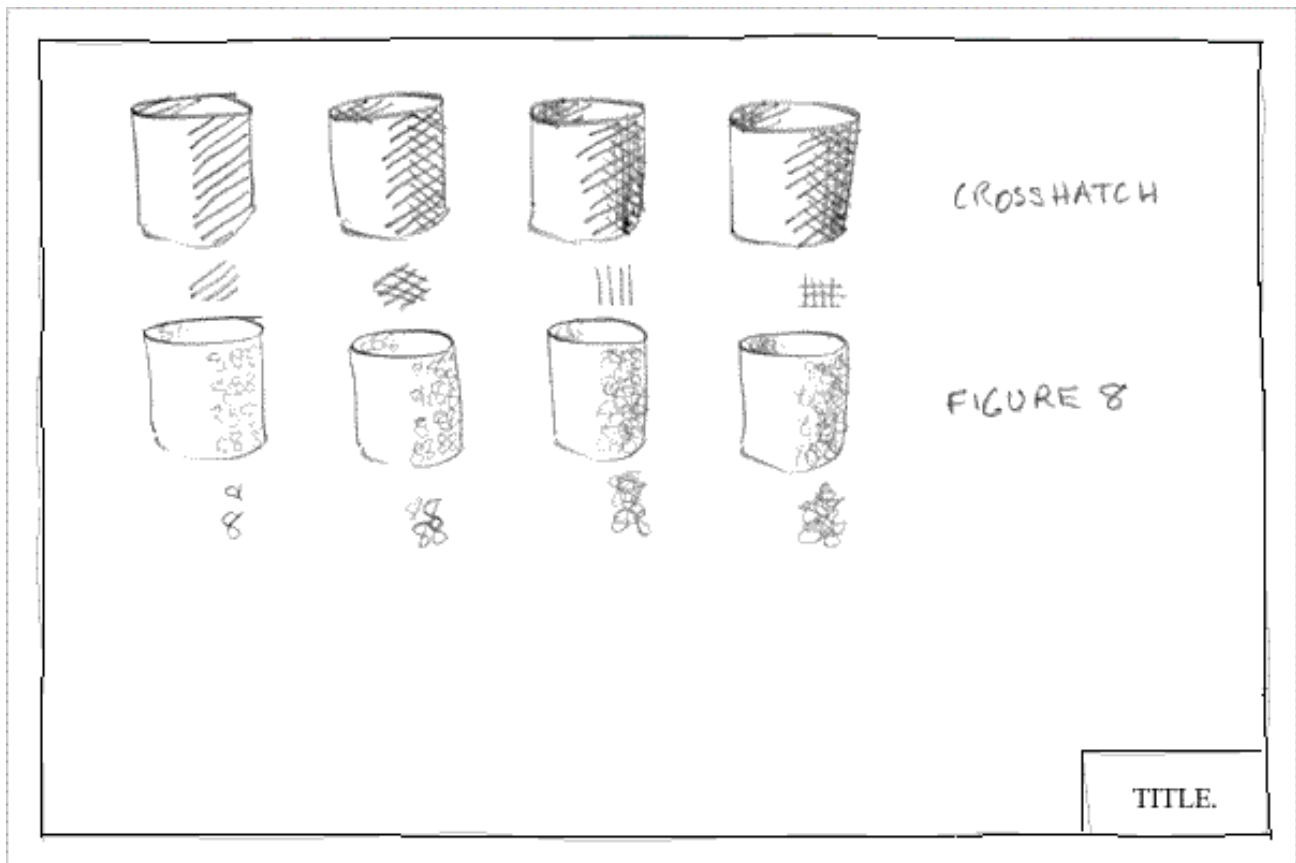

g) Make another row of four cups. Again using your 4B pencil and 'light pressure' make a series of lines using cross hatch or '8's. With the end of your finger rub the pencil lines until they merge together and form a flat even 'smudge'. Try and stay within the edges of the cup. Repeat this and darken as you near the right hand edge of the cup. Again, do not neglect the top lip.

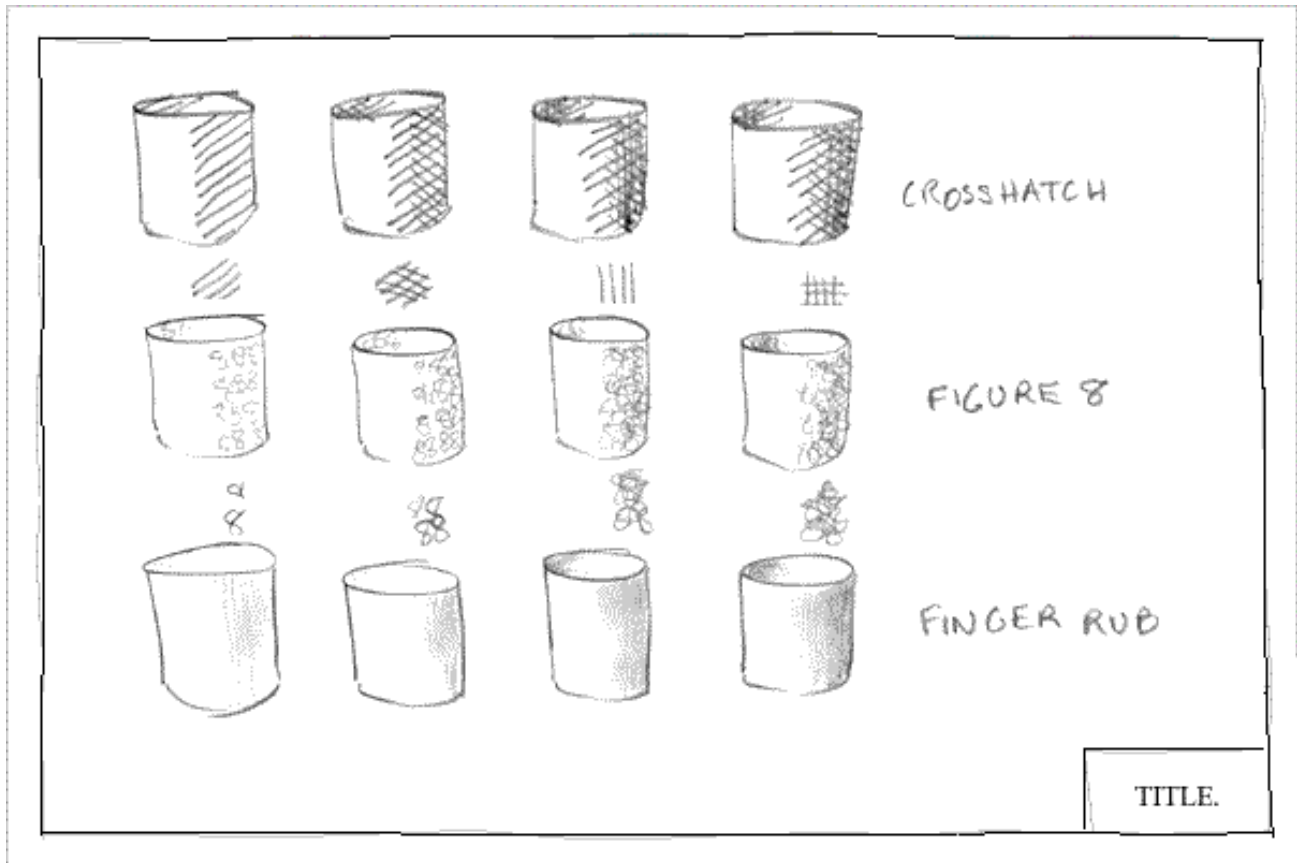

Label the three methods and title the drawing 'shading'.



TENNIS CUPS

[lesson menu](#)

PART 2: LESSON 2 - SHADING

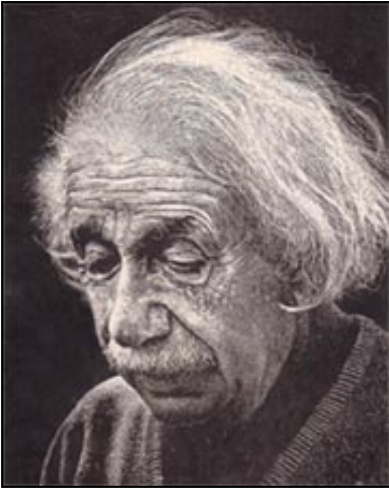

TIME: Allow 40min

Aim: To introduce reflected light and its effect on shadows and shading. To develop the use of shading for a textural effect.

Materials: The sketch pad, HB and 4B pencil, eraser

Allow five minutes to for the quick sketch test. Two minutes to do and three to mark. Swap, display and title if necessary.

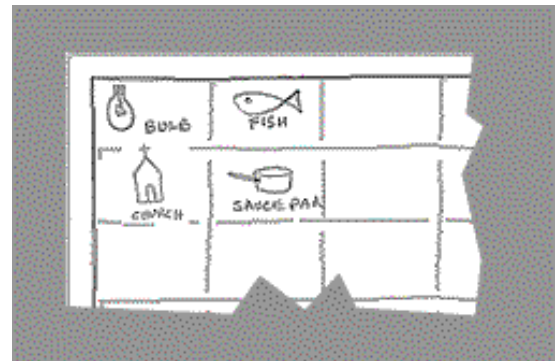

a) Without using the ruler (or any other straight edge) prepare the page with margin and add the freehand boxes as shown previously.

While the students are thus occupied hand out these prepared theory sheets.

Sitting in the garden I asked a person if the shadow cast by a tree would be lighter on a sunny day, than it would, at a similar time, on a cloudy day.

'Does it really matter?' he shrugged, as he poured himself another glass of my most expensive imported red.

'That depends.' I replied, 'one day you might want to paint a shadow.'

'The grisaille legacy'

'I met a man of black and white who had sadly lost his way.

Wringing his hands, he said to me, "but all I see is grey".'

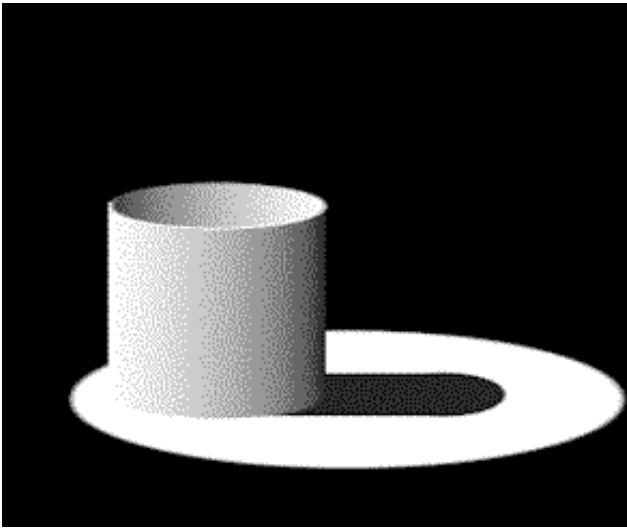

If a cup was placed in a spotlight the shadow it cast would be as black as the surrounding darkness while the shading on the cup should move from a grey at the 'turning point' to a similar blackness.

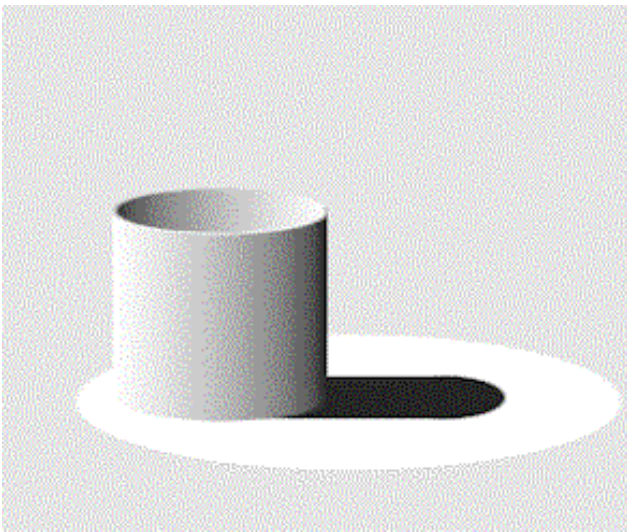

However, if there was some other light in the room the 'black' shadow would look out of place - as shown above. The reason for this is that in our normal life we mostly don't live under spotlights. Usually, there are many sources of 'reflected' light around us. In a room or outside our shadows are rarely completely black as they are modified by the 'general lightness' of the day - or the room.

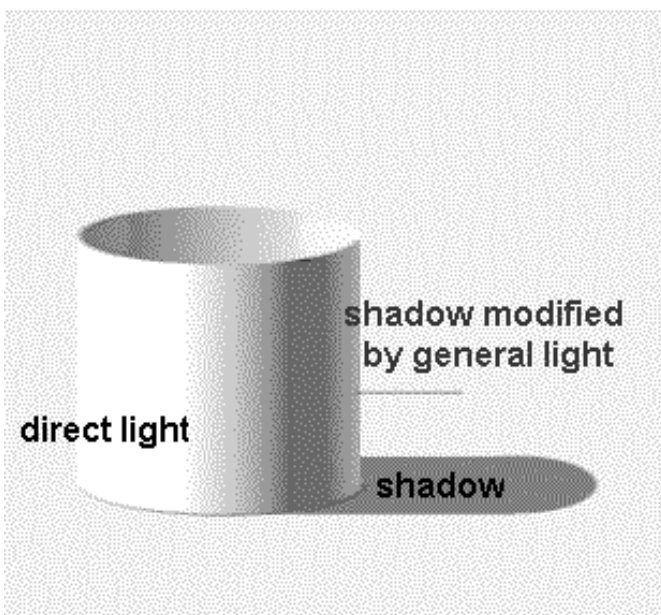

Therefore a more 'realistic' rendition of shading and shadow would be as shown above. This can be

better understood by referring to my general lesson on side light and turning points in the 'painting' section.

b) Lets now go back to our prepared sheet and our lesson for making a quick drawing of a tennis ball.

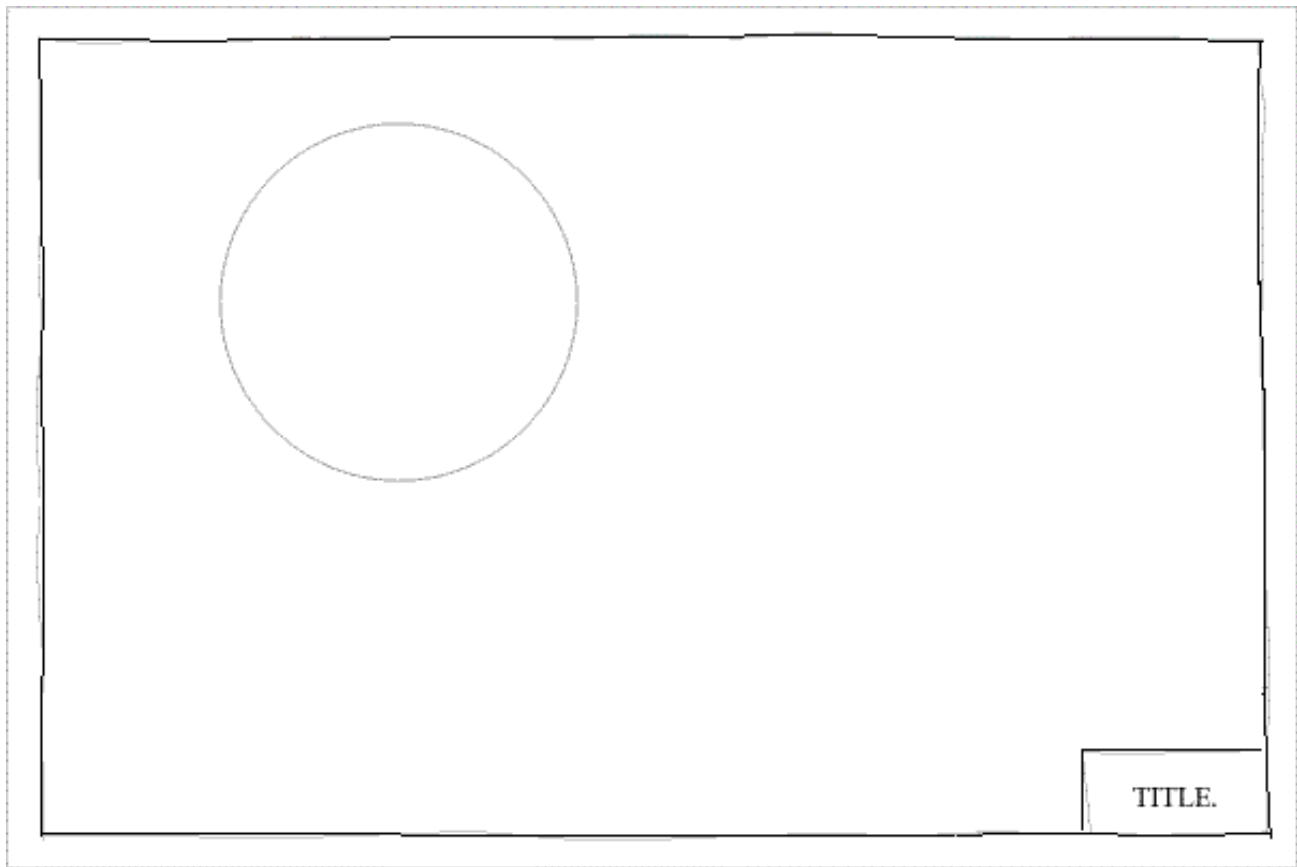

Using the method we learnt in part 1 for making a freehand drawing of a large circle - draw one of the approximate size and position shown.



Employ the figure 8 and smudging method to shade the ball (medium to light weight pressure) ... but leave the two 'S' shaped 'tracks' as shown.

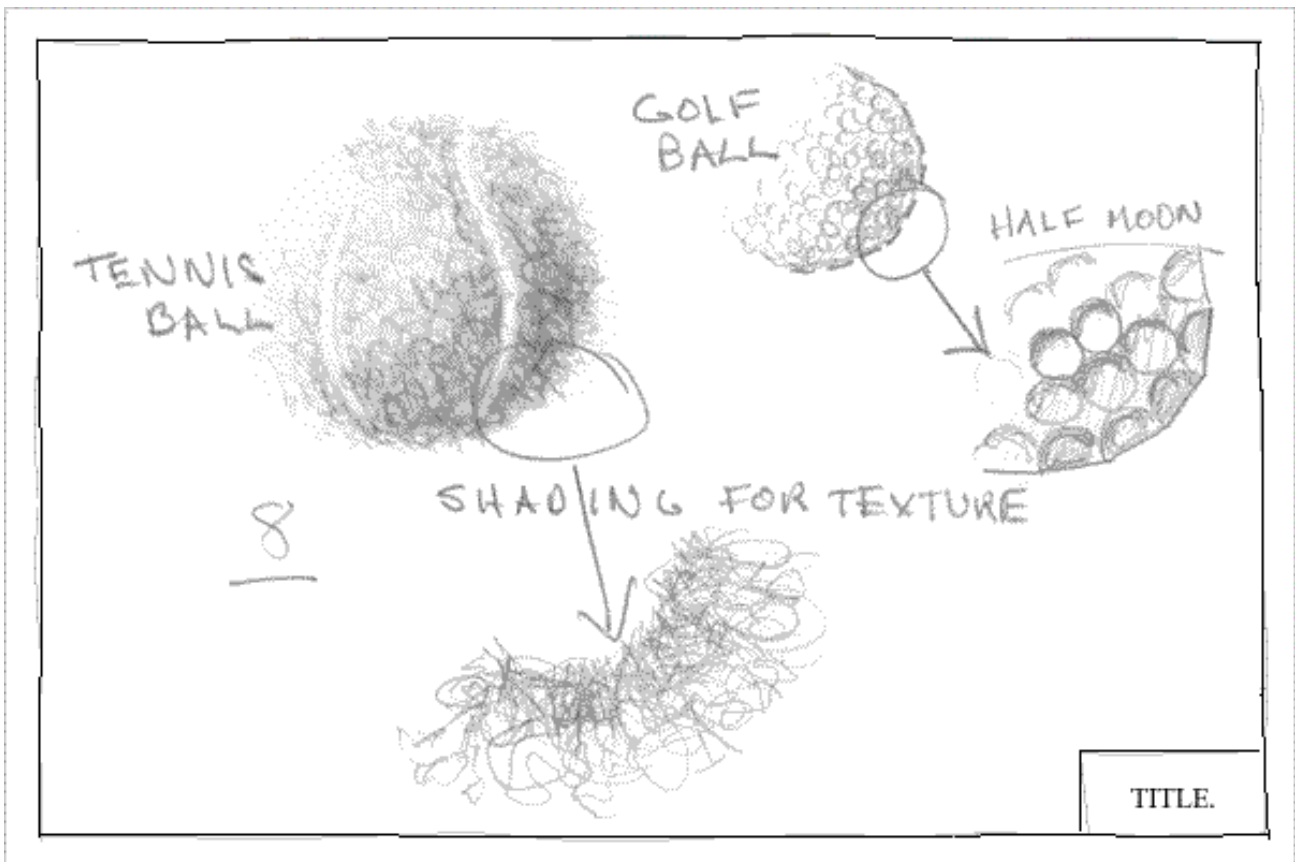

Increasing the pressure with your 4B pencil show some of the 'fluffy' hair at the turning point and at the edges.

HOMEWORK

Find a golf ball, baseball, basket ball or one other and draw it along side the tennis ball. It is

necessary to look up [texture](#) and [advanced texture effects](#) before you begin your drawing assignment.



[GO TO ... TEXTURE](#)

[lesson menu](#)

PART 2: REFERENCE SHEET ON TEXTURE

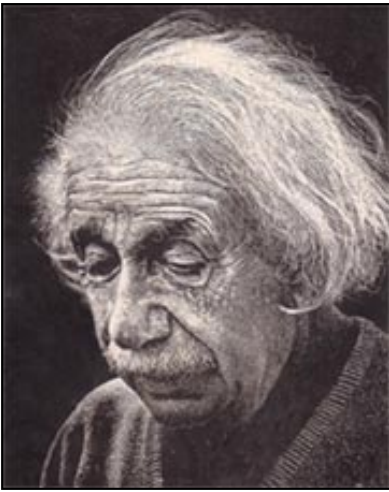

TIME: reference sheet

Aim: At this stage I thought it might be valuable to show how we can combine shading and texture in the one drawing. Later we shall be doing more work on this but for now it is sufficient to show the student what they will be able to do if they apply themselves to the lessons so far. All the techniques are already described.

Scraperboard is a board made of a backing, a layer of compressed whiting/adhesive mix (approx 1mm thick) then covered with a film of black indian ink. An incredibly fine white line is etched with a stylus as it is dragged across the surface. The flat edges of the stylus are sharpened and used to scrape larger areas clean of the ink. The boards can be bought already made as can the stylus and other tools for the scraping process.

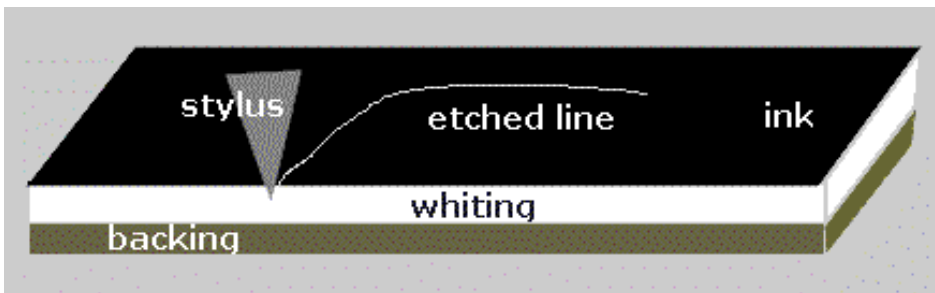

In earlier days, when I was possessed by a steady hand and keen eyesight, I produced an exhibition of 28 scraperboard drawings of which the drawing below is but one example I have scanned from an old exhibition invitation cover.

Alas, none remain in my possession and I needed to search my records for the one shown to scan it and show it to you as an example of 'drawing with texture'.



I used little 'cyphers' or curves(below)for the wollen texture of the pullover(very similar to the furry tennis ball in the previous lesson) and straight lines (single hatching) for the skin texture. There was little opportunity for 'cross hatching in this drawing apart from the hair when a confused tangle is required.

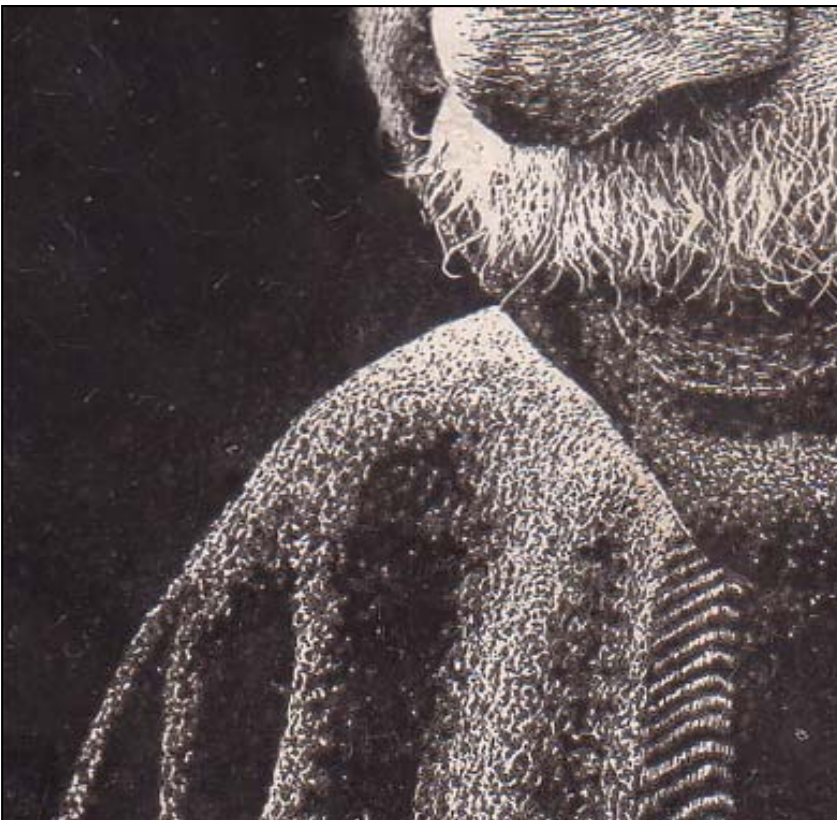

You will note how the skin can be textured either along the folds, as in the forehead, or across the folds as in the nose and cheeks. This produces a 'dynamic tension' that can be used to emphasise roundness or flatness. For those students who decide to advance into painting it is useful to realize this same 'directional line' is the direction the painter would employ with the brush to give the human body appropriate 'dynamic tension'.

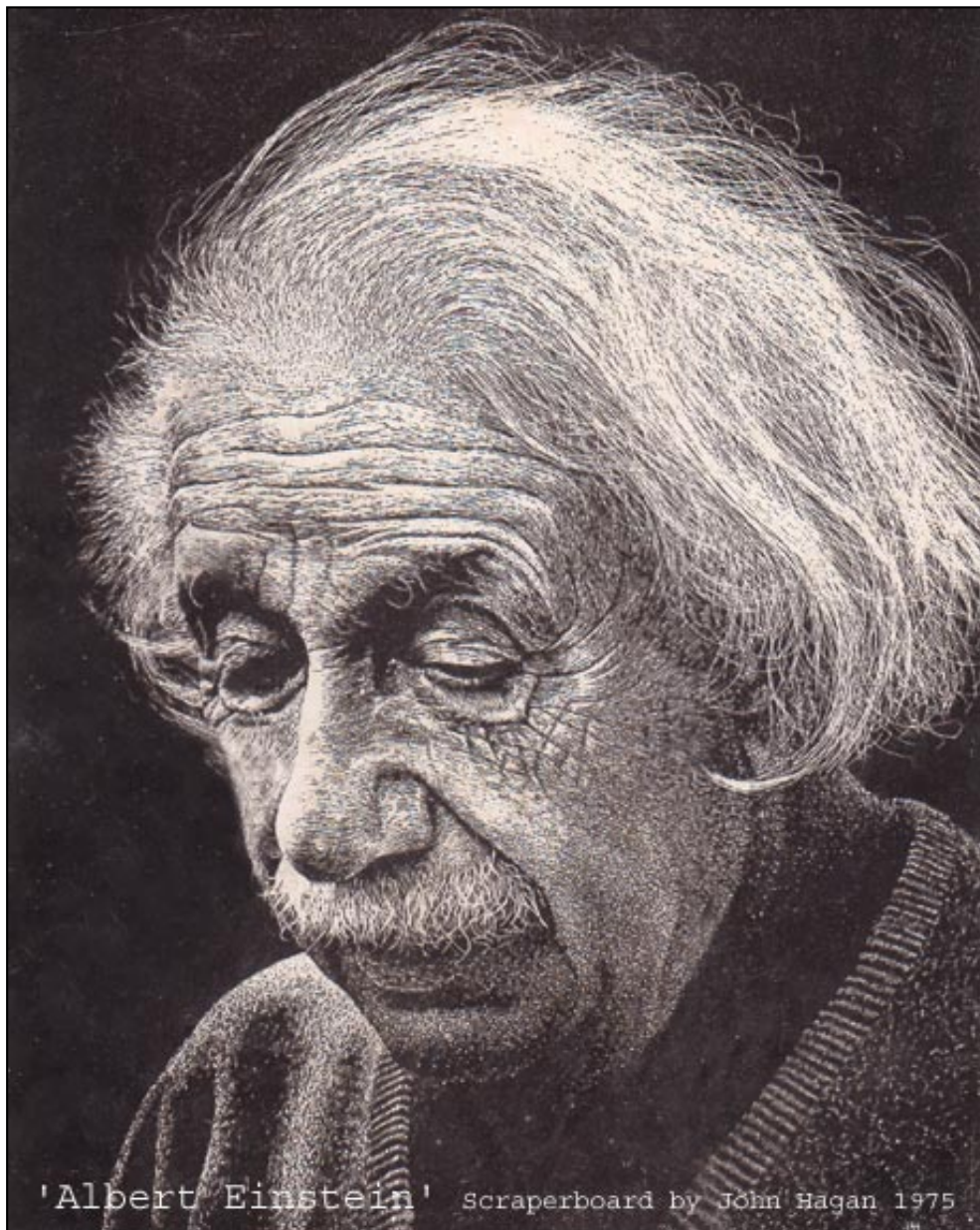

Full size approx 10" by 12" in private ownership (heaven knows where it is now for, at the time, it was purchased by a restaurant owner for \$300 and free meals whenever I was desperately hungry, which was quite often in those days!)



[GO TO ... LESSON THREE](#)

[lesson menu](#)

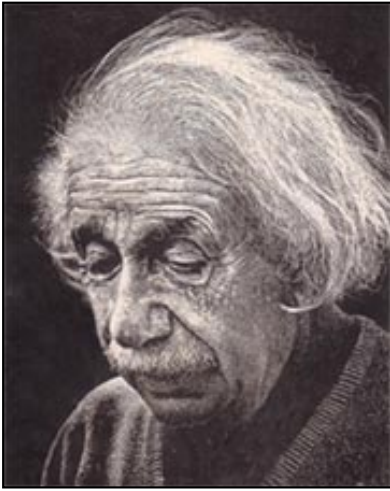

PART 2: LESSON - 3D DRAWING

TIME: Allow 40min

Aim: To introduce the basis of three dimensional drawing and apply to drawing.

Materials; The sketch pad, HB and 4B pencil, eraser, a ruler if need be.

Allow five minutes to for the quick sketch test. Two minutes to do and three to mark. Swap, display and title if necessary.

Draw a little butterfly on your page in approximately the same position as mine.

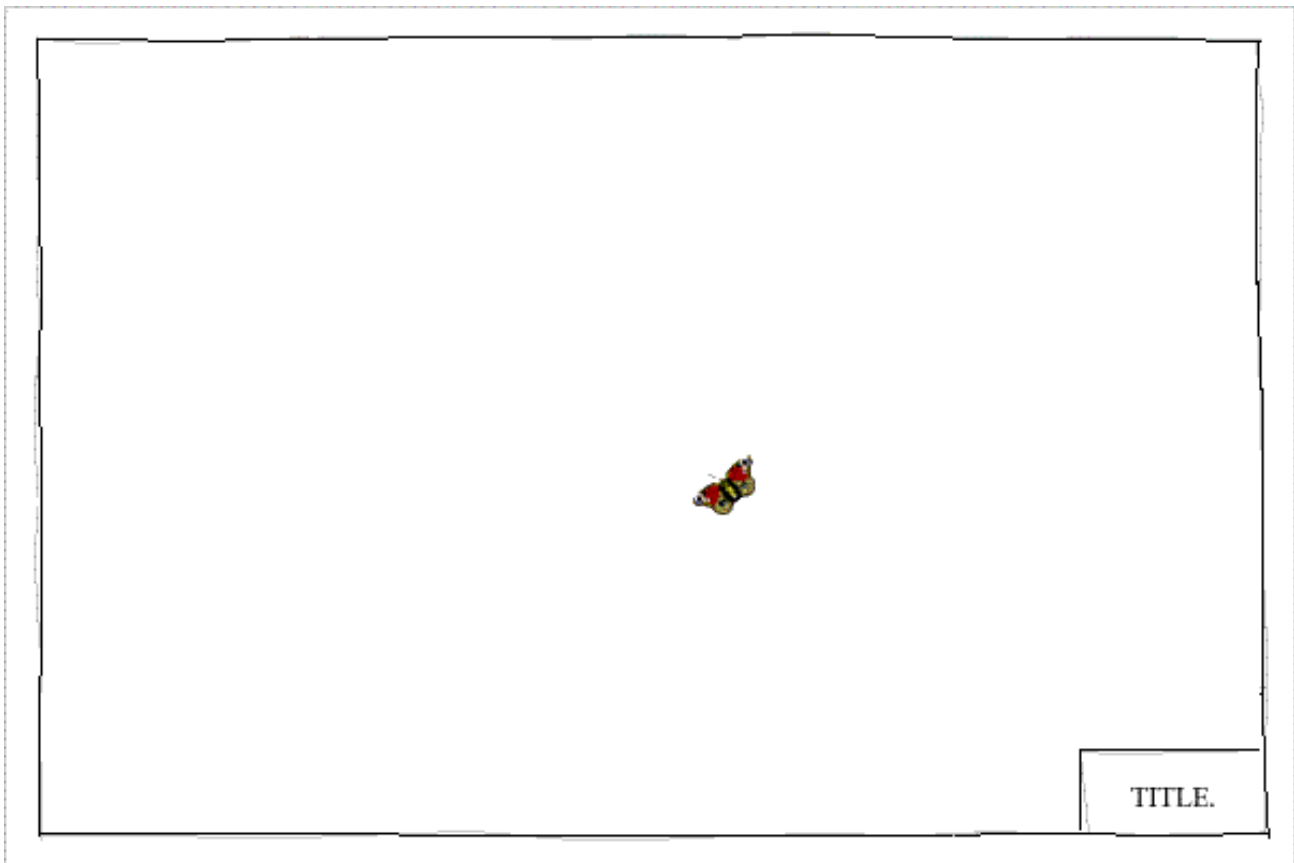

But where exactly is the butterfly? How far from us, how high above the ground? We have no idea until we 'place' our butterfly. To do that we shall put her in a (reference) box or cage. See below ...

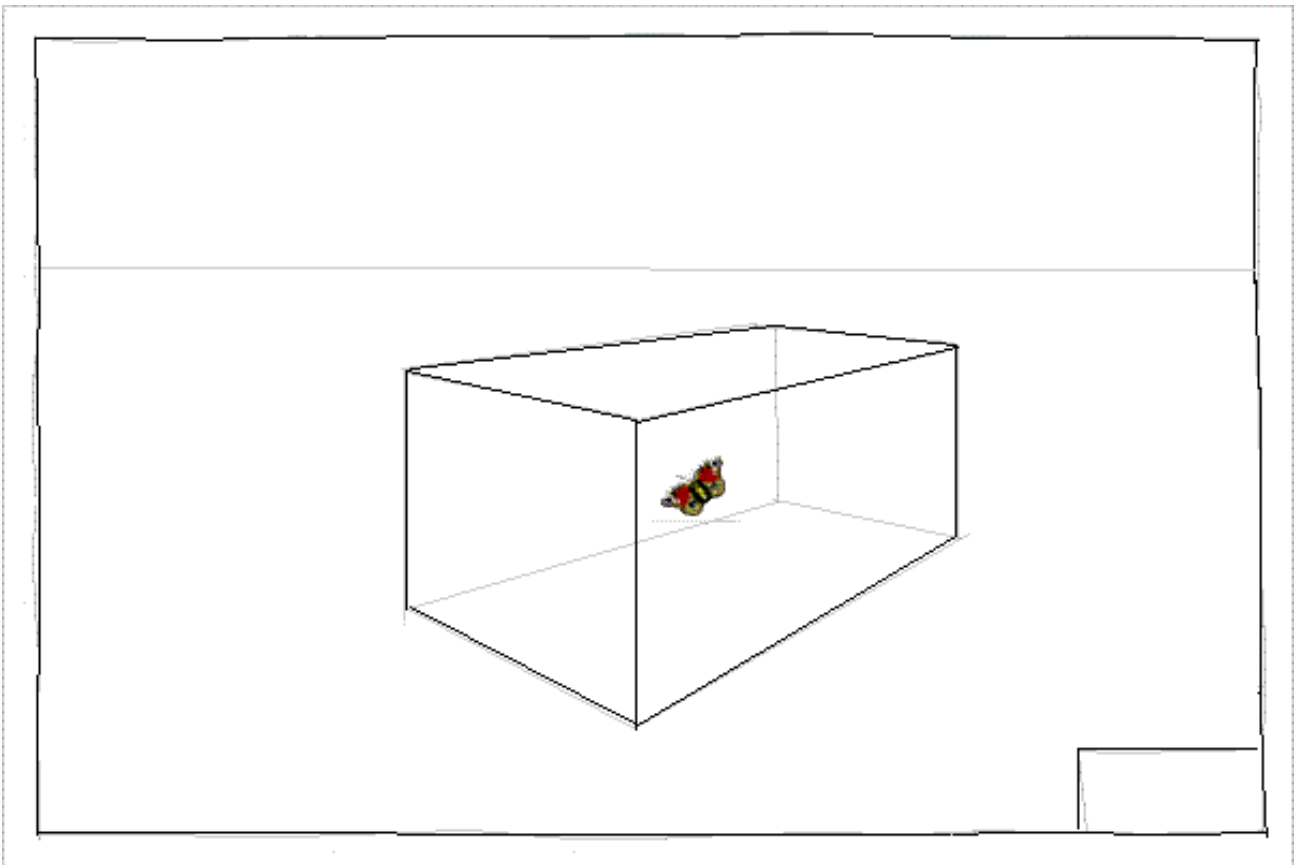

Now we have our reference and we can relate the position of the butterfly to something tangible, specific. Furthermore if we draw a line 'forward' from our butterfly we can decide where we want our butterfly in relation to the front of our box (point 'a')

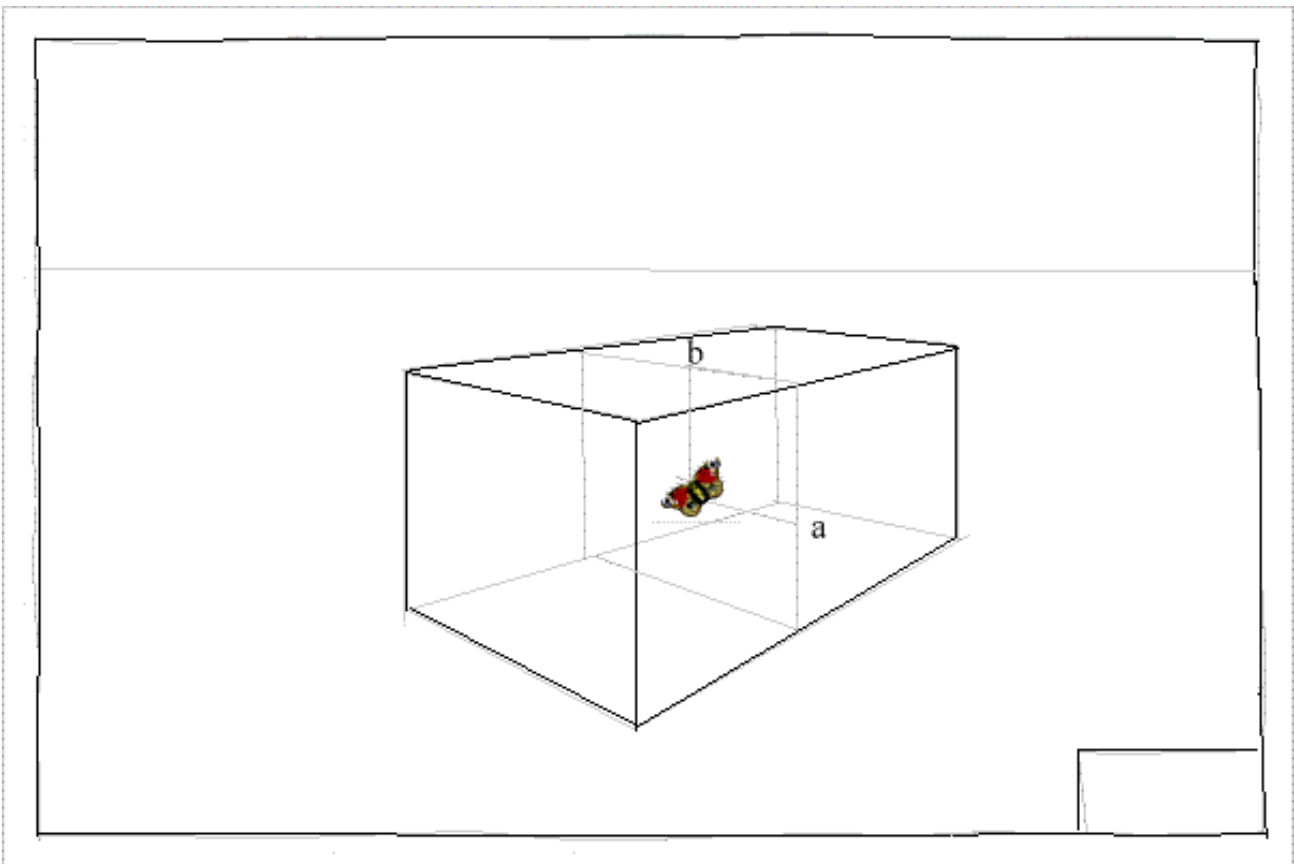

In a similar fashion if we project a vertical line up from our butterfly we can relate the butterfly to the top of our box (point 'b'). But how far up? Since the butterfly is in a set place then point 'b' can be joined by the vertical projection and by the projected line to the left vanishing point. It is as if we sliced through our box and the 'plane' of that slice suddenly cut through the middle of our butterfly.

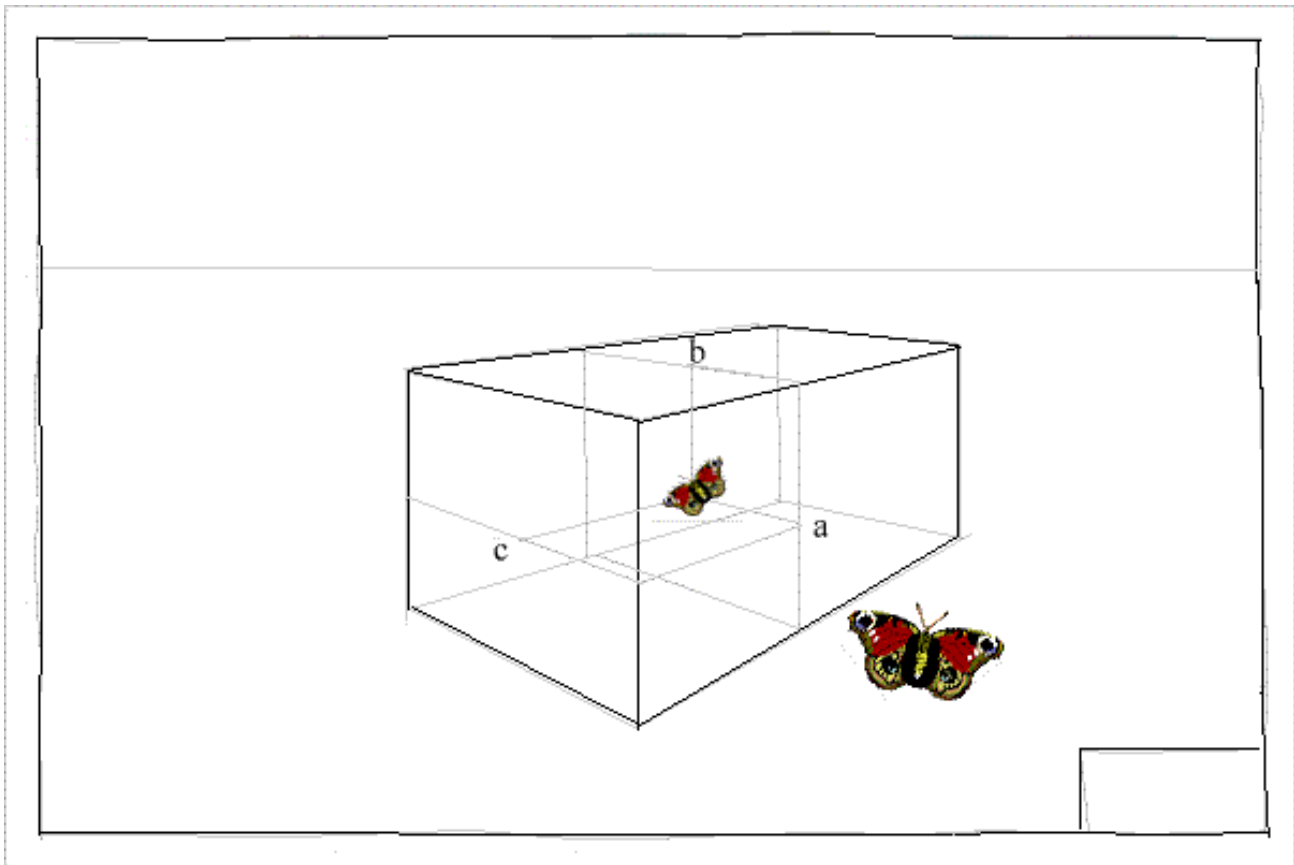

Do this again and locate the butterfly on point 'c' the left hand front surface. Such is the method we can obtain the 'three dimensions' that locate our butterfly in space. Of course we needed to 'reference' the butterfly within a box. Now we have our 'three dimensions'. The bigger butterfly I have introduced is much closer and can be related to the first in a similar manner.

HOMEWORK

Prepare for the next lesson by drawing a 'top view' and 'side view' of a common fork.



[GO TO ... LESSON FOUR](#)

[lesson menu](#)

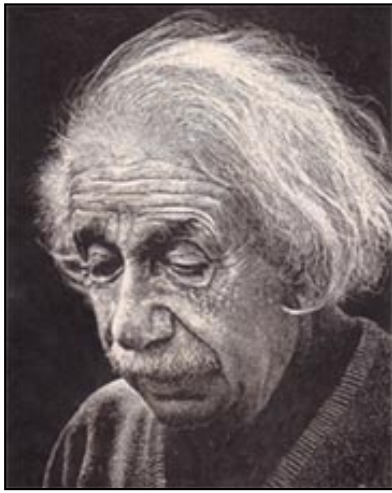

PART 2: LESSON - DRAWING A FORK

TIME:

Allow 40min

Aim:

To apply in reverse the principles learnt in our previous lesson to drawing objects that have more complicated three dimensional shapes.

Materials:

The sketch pad, HB and 4B pencil, eraser

Allow five minutes to for the quick sketch test. Two minutes to do and three to mark. Swap, display and title if necessary.

Prepare the sheet as usual then using the prepared top and side view of the common fork draw a box of appropriate dimensions as shown.

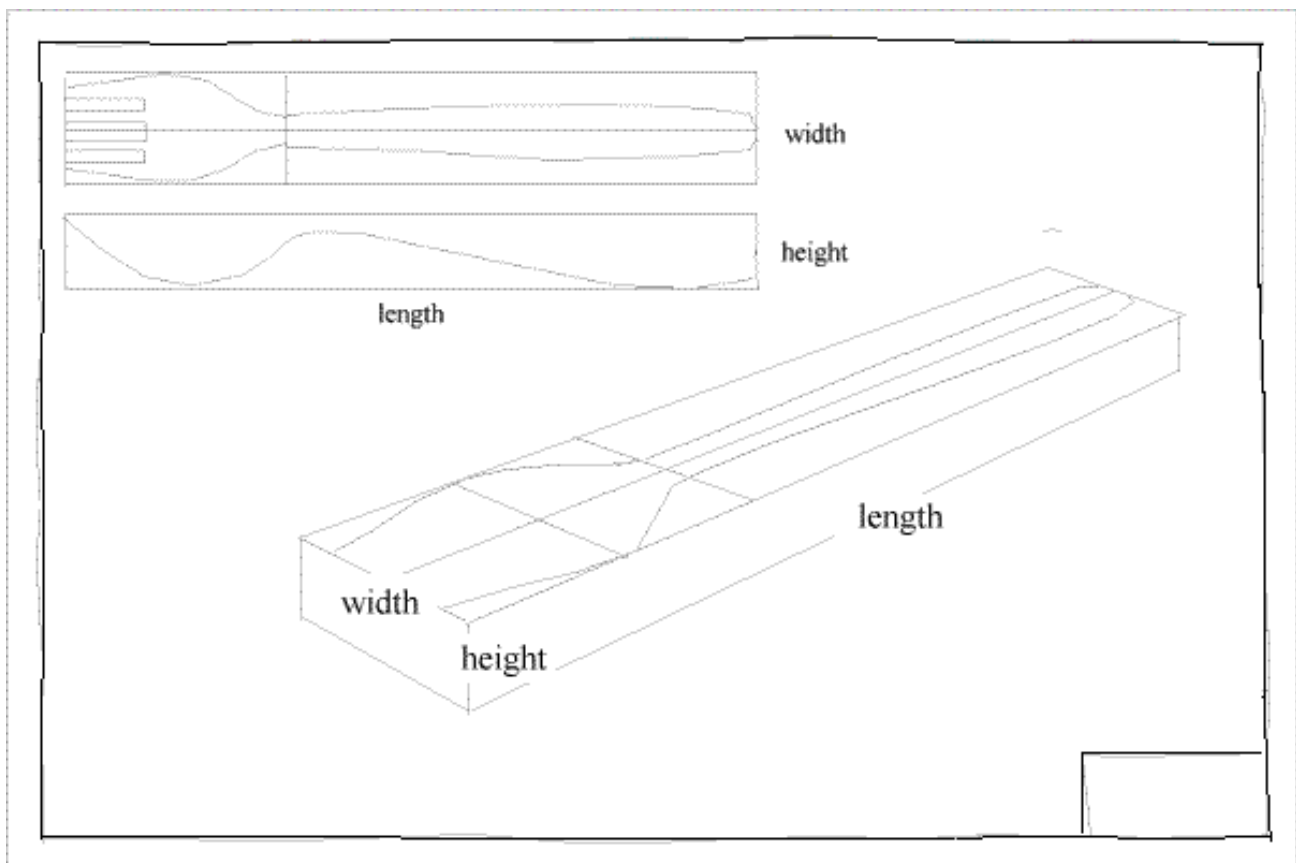

On the top surface draw a 'flat' top view of the fork.

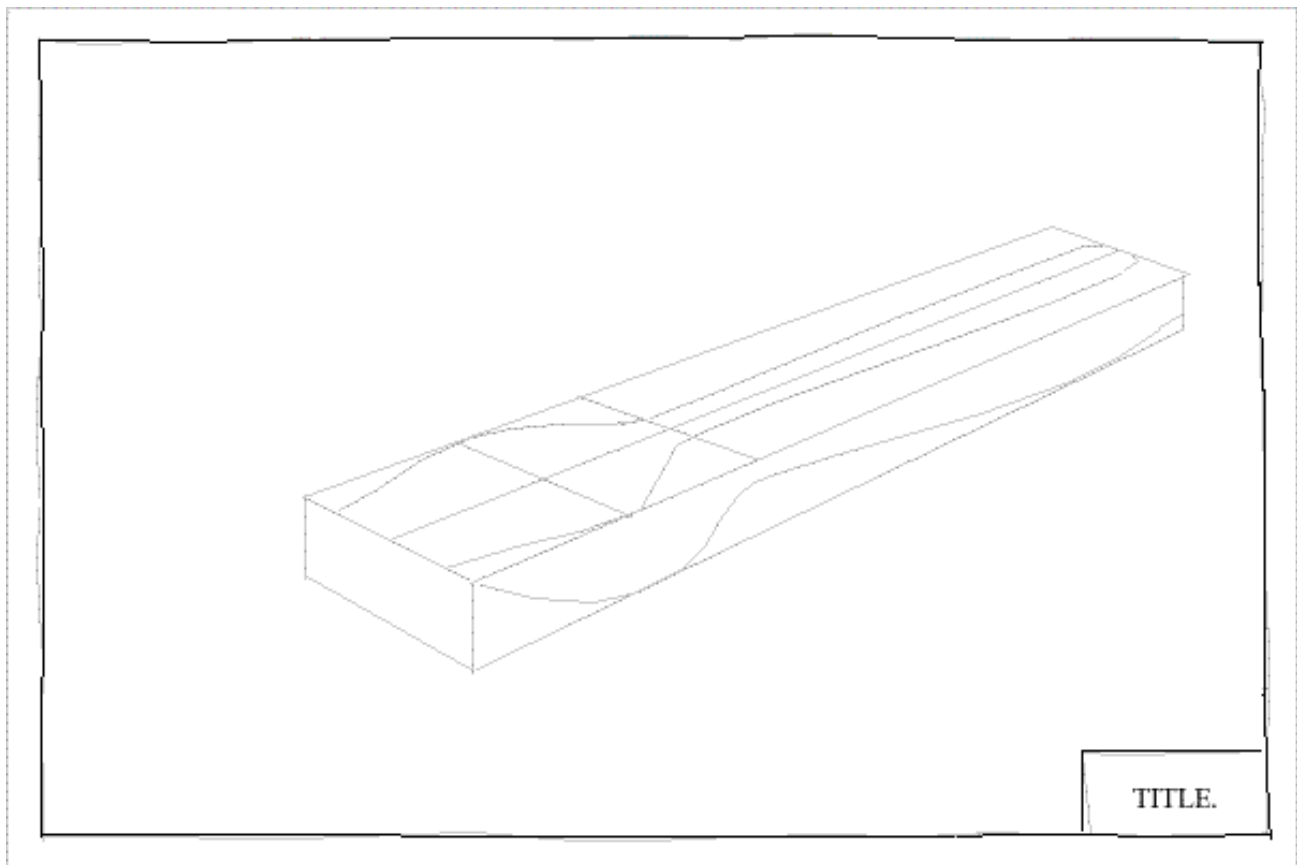

Draw a side view on the front right hand surface as show.

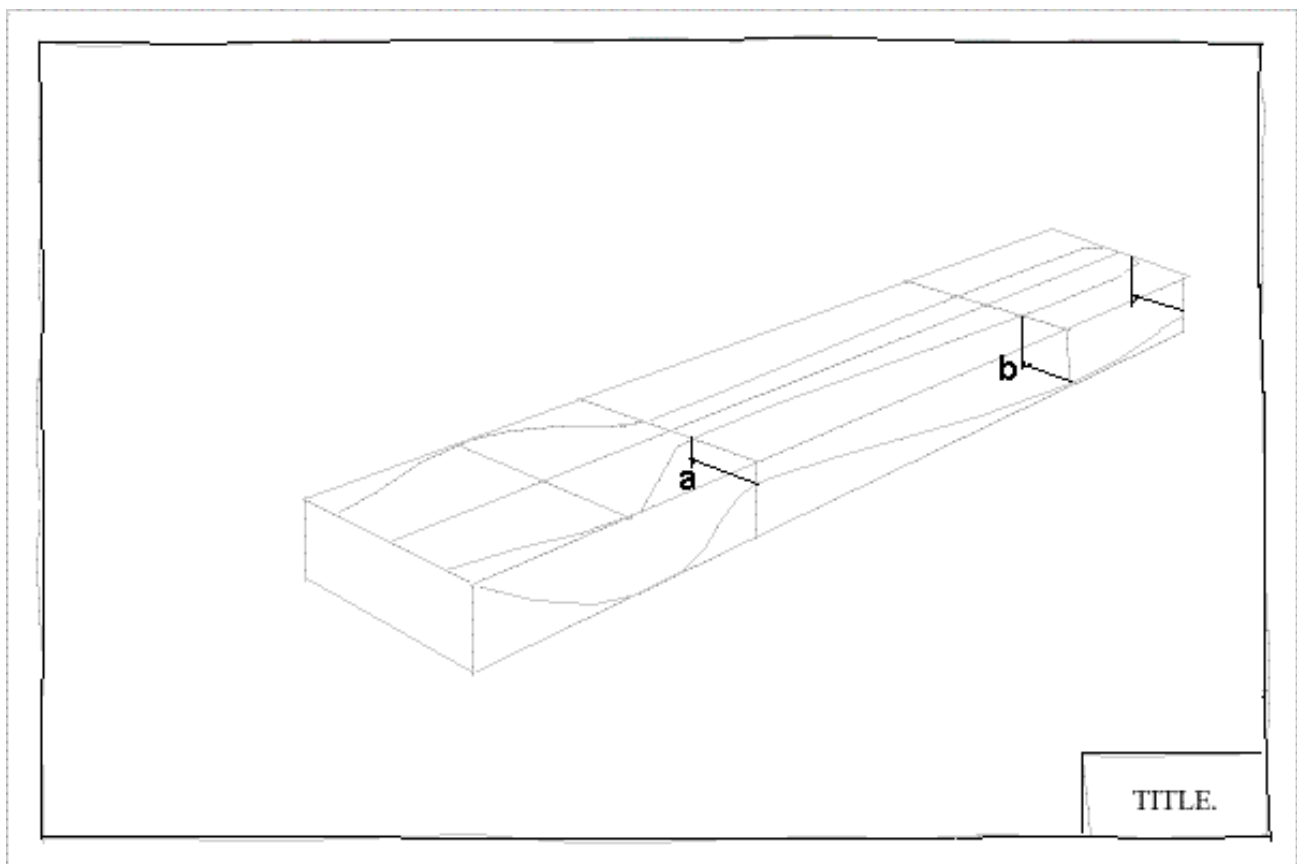

If we now project light lines 'in' from the front view and 'down' from the top we can locate as many points as we like on the edge of our fork ('a' and 'b').

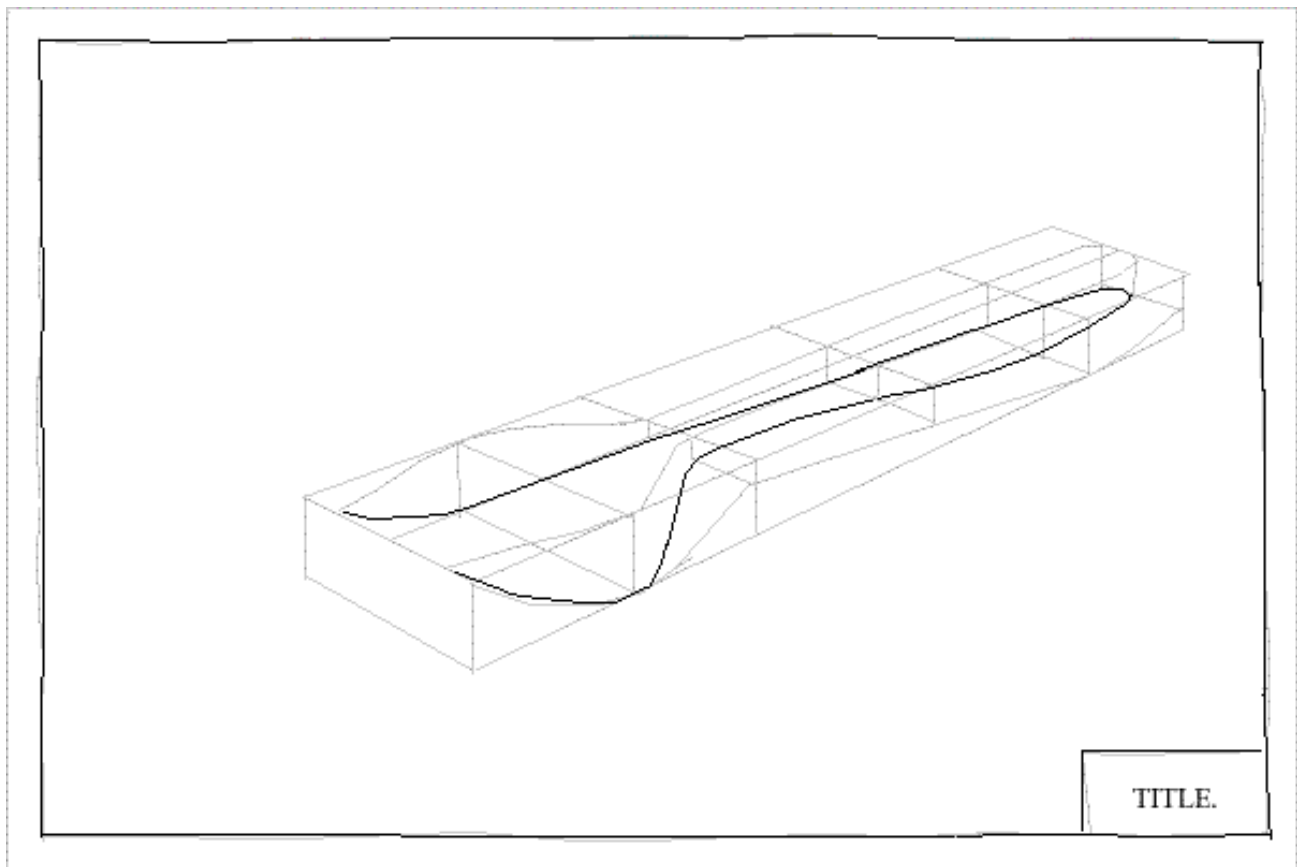

Join all these points up with nice smooth freehand curves as shown.

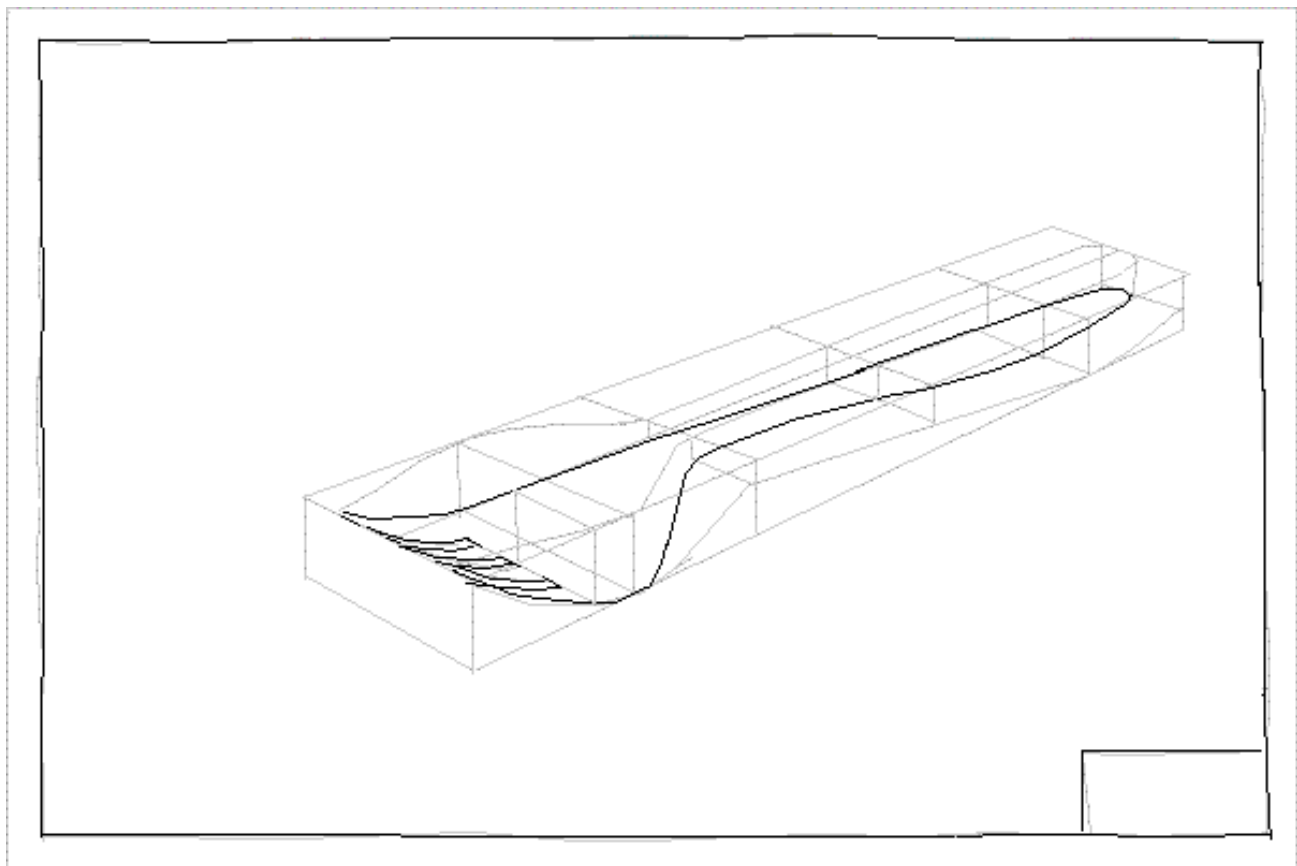

Complete as shown above taking extra care with the prongs.

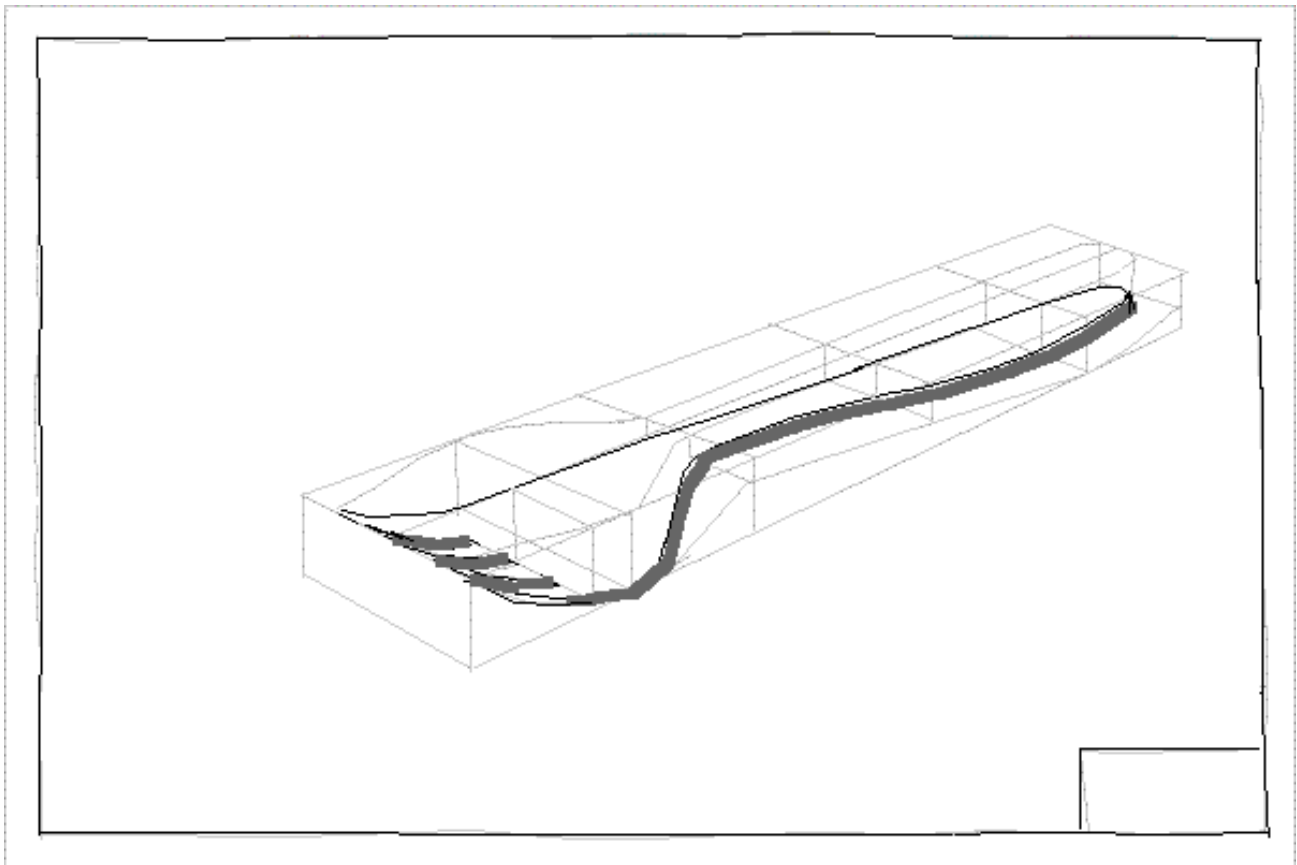

Now let us give our fork a little 'thickness' using shading on the front edge.

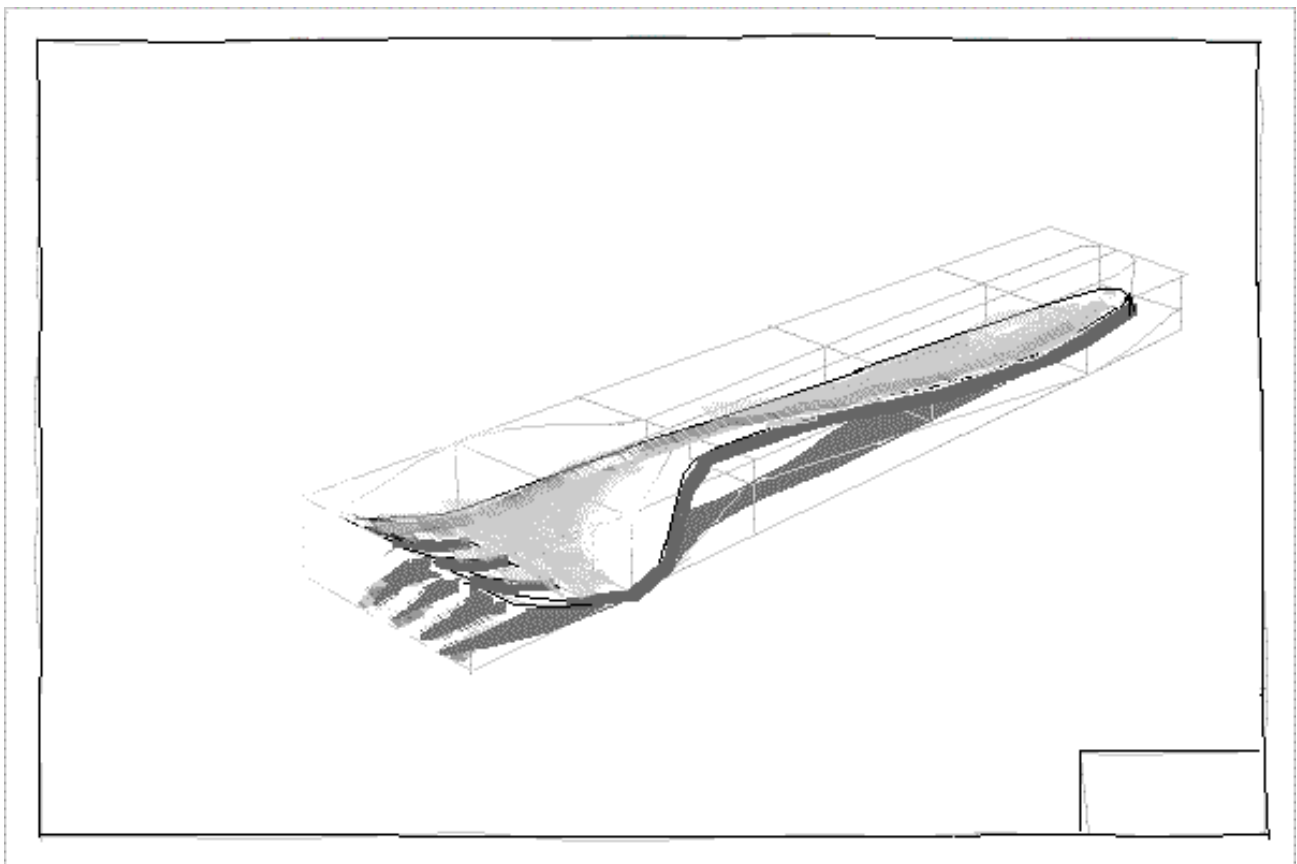

Shade in the rest of the fork and add a shadow where appropriate. If you have a fork with you on your desk you can adjust the shadow as you see it, otherwise just copy mine.



HOMEWORK

Refine the drawing and add a knife.



[GO TO ... PORTRAITURE](#)

[lesson menu](#)

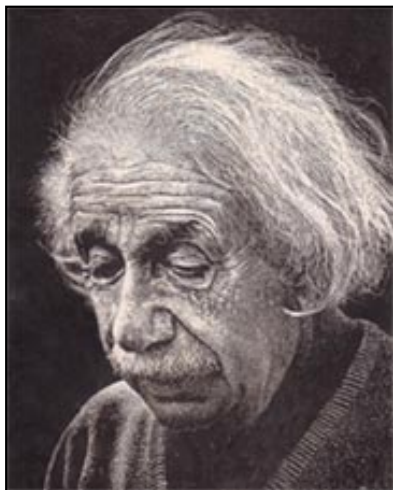

PART 2: LESSON - PORTRAITURE

TIME: Allow 40min

Aim: To study draw a portrait using the 'inside-out' method.

Materials: The sketch pad, HB and 4B pencil, eraser, a ruler for measurements if need be.

Allow five minutes to for the quick sketch test. Two minutes to do and three to mark. Swap, display and title if necessary.

Mostly everything we draw is based on regular solids such as cubes, spheres, cylinders and pyramids ... or a combination of them all. In this lesson we shall be using a sphere, a half-pyramid and a cylinder.

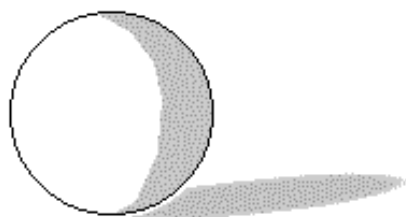

Sphere

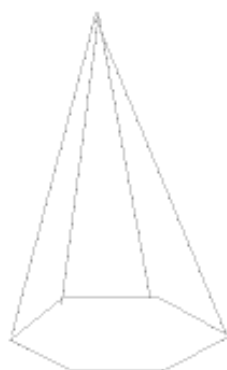

Pyramid

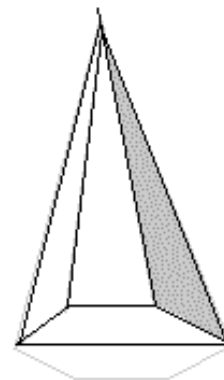

Split pyramid

First we construct a light circle in the approximate position and size shown below.

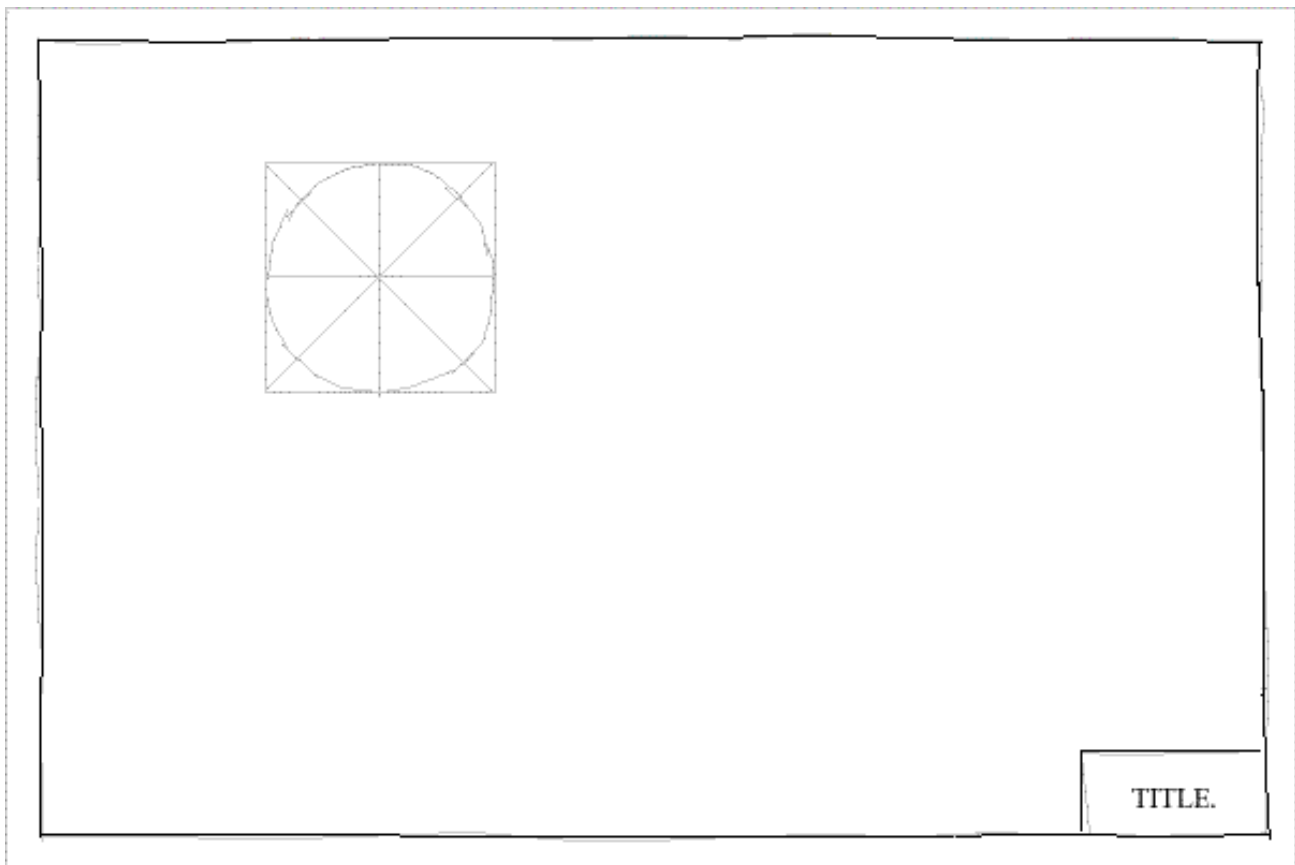

Draw another circle in the position shown (exactly one full circle apart). Using a nice 'sickle moon' arc describe the edges of the shadows that will give the spheres some depth.

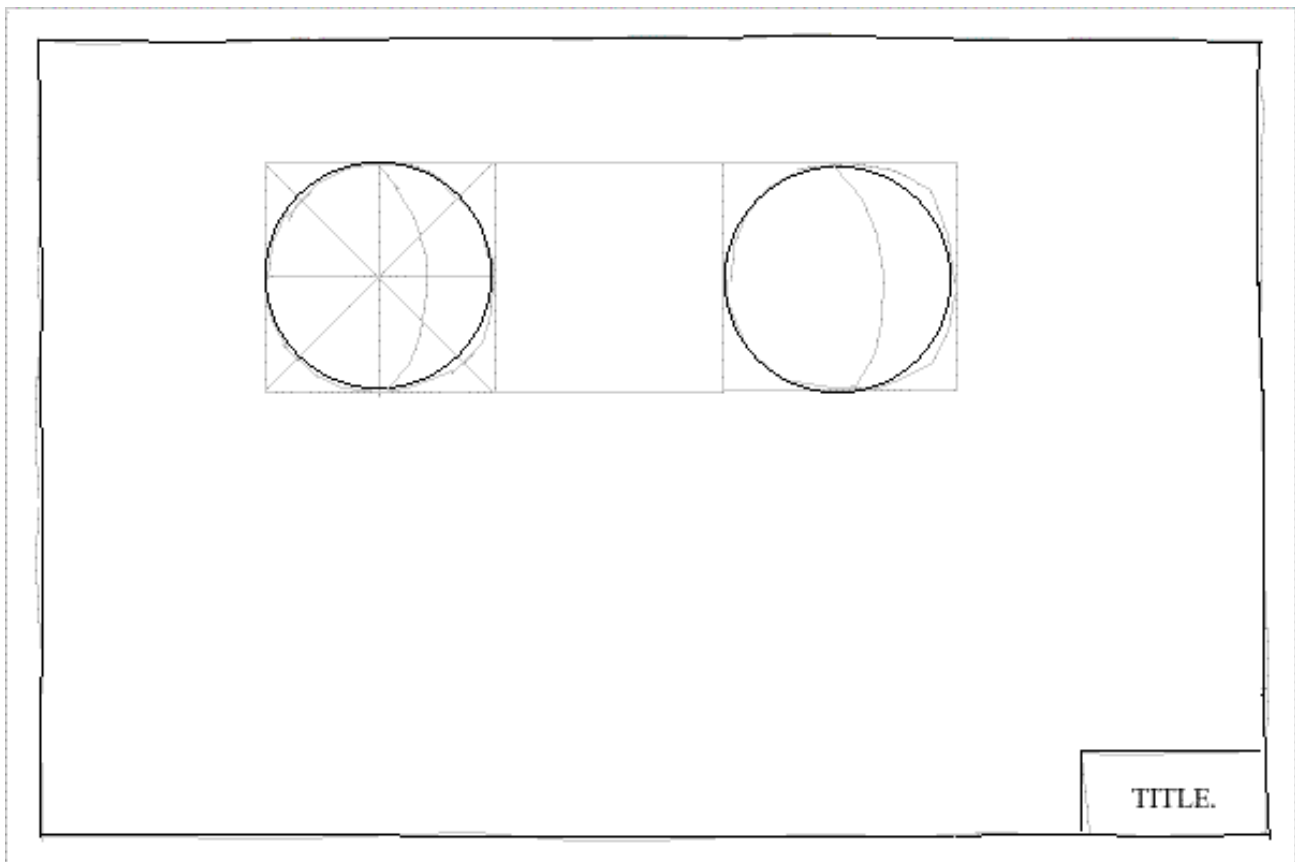

Shade in the shadow parts of the twin spheres.

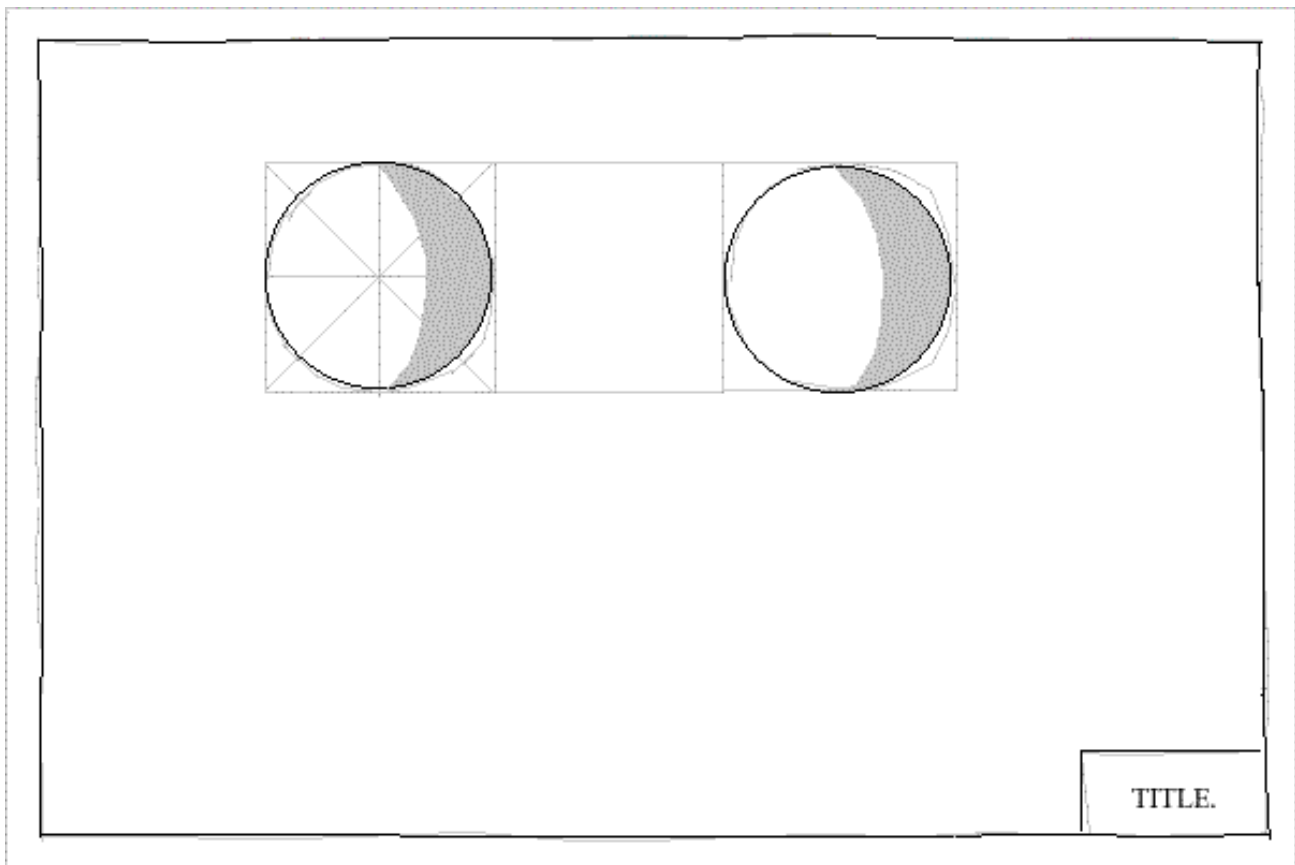

Copy the eye shapes from my drawing being careful to keep them level and sketch the little inside corners as I have done.

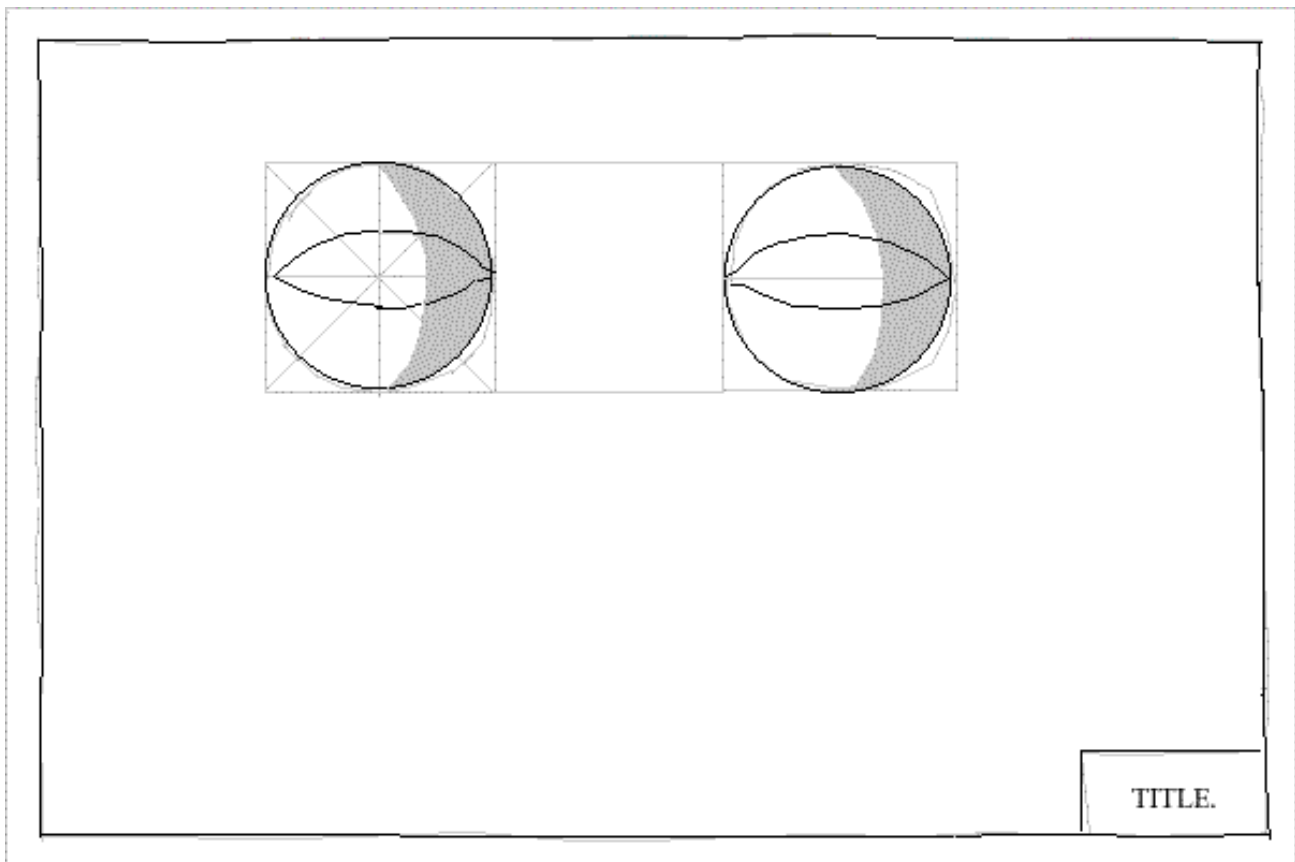

Add the eyelids and circle in the iris and pupils as shown below. To make the eyes look right or left you would position the pupils accordingly.

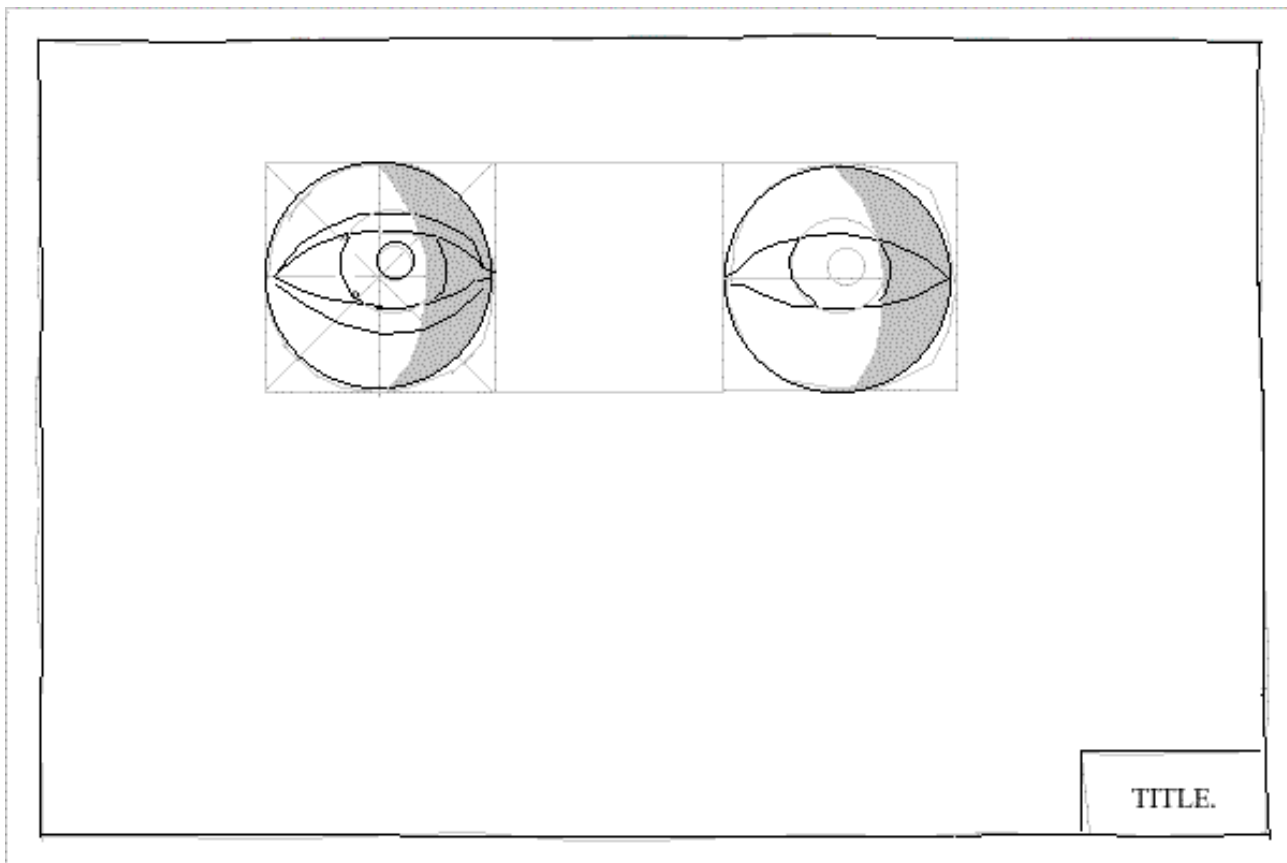

Shade in the pupils and irises. Remember the pupils are actually holes and therefore shadows.

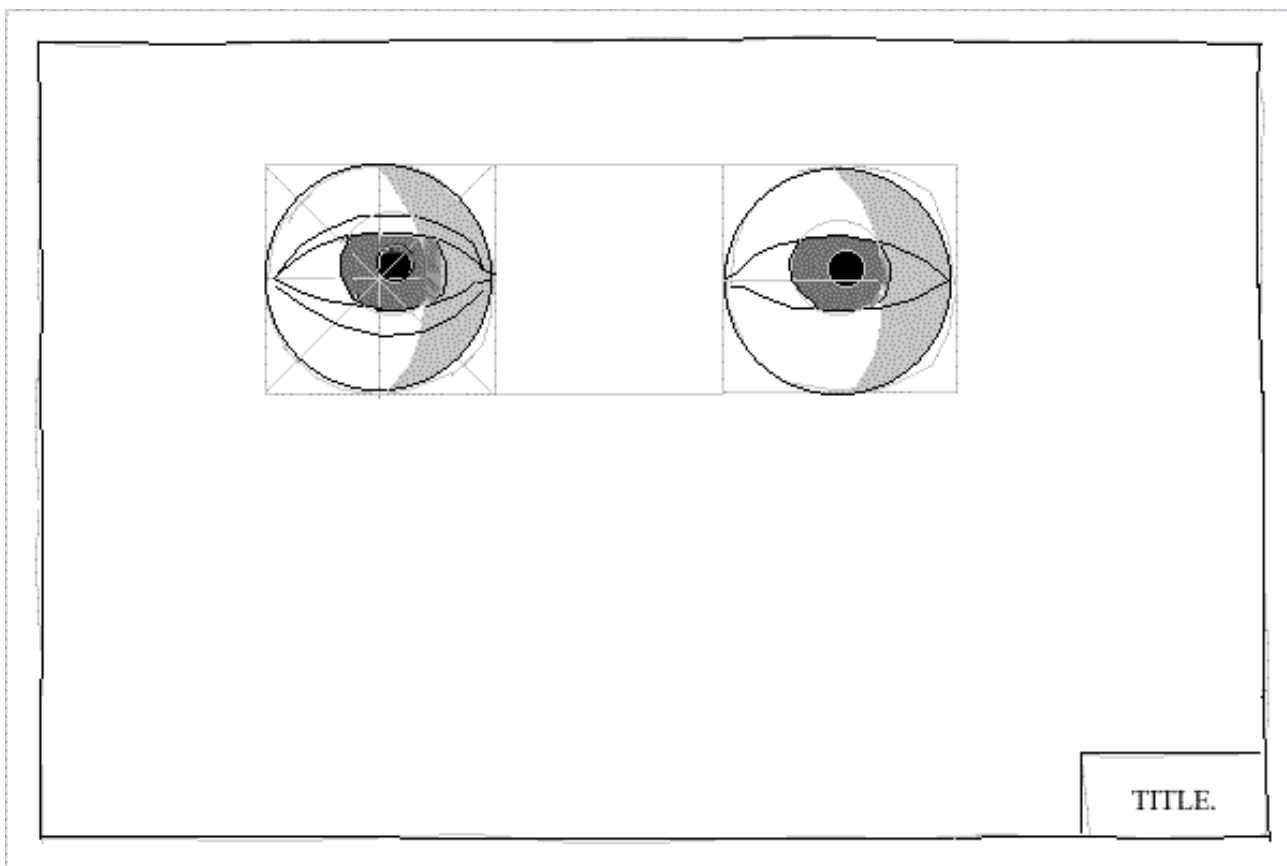

[GO TO ... PORTRAIT \(CONTINUED\) 2](#)

[lesson menu](#)

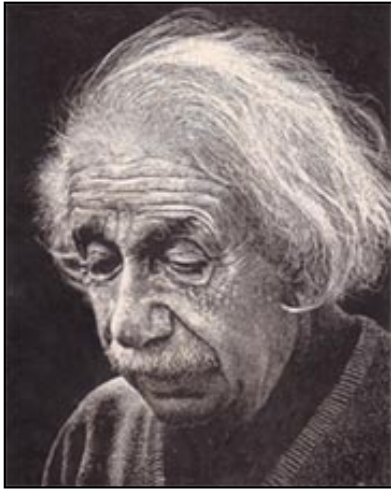

PART 2: LESSON - PORTRAITURE 2

TIME: Allow 40min

Aim: To study draw a portrait using the 'inside-out' method.

Materials: The sketch pad, HB and 4B pencil, eraser, a ruler if need be.

Allow five minutes to for the quick sketch test. Two minutes to do and three to mark. Swap, display and title if necessary.

Using your eraser make the small highlights in the eyes that give them their sparkle. The amount of 'sparkle' should differ from one eye to the other. Sometimes you would 'sparkle' one eye only as the other might be in shade. Careful observation is the key.

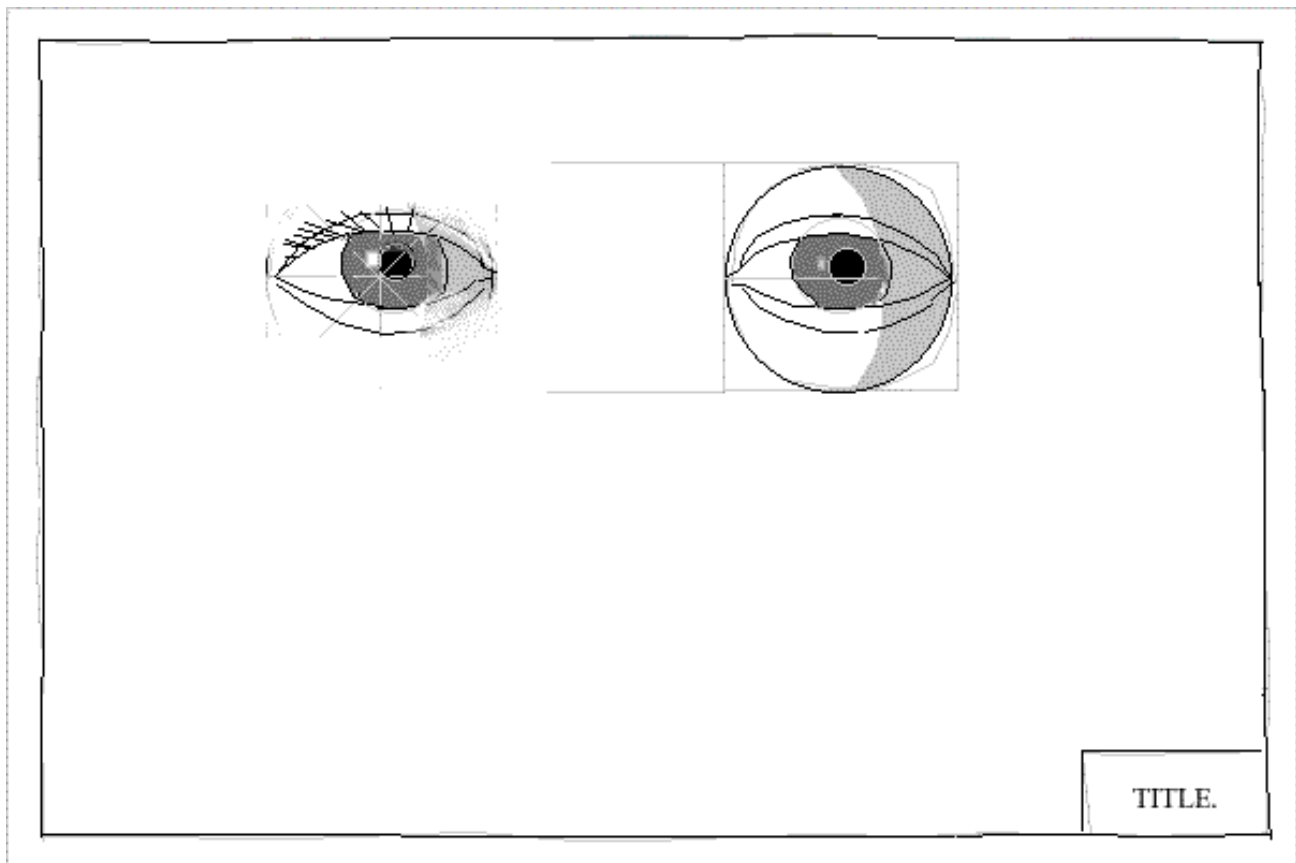

You can suggest some eyelashes at this stage. Next we will construct the pyramid that will give us our 'design' for our nose. All you will need to do in the future is to remember these basic structures when doing your portraits.

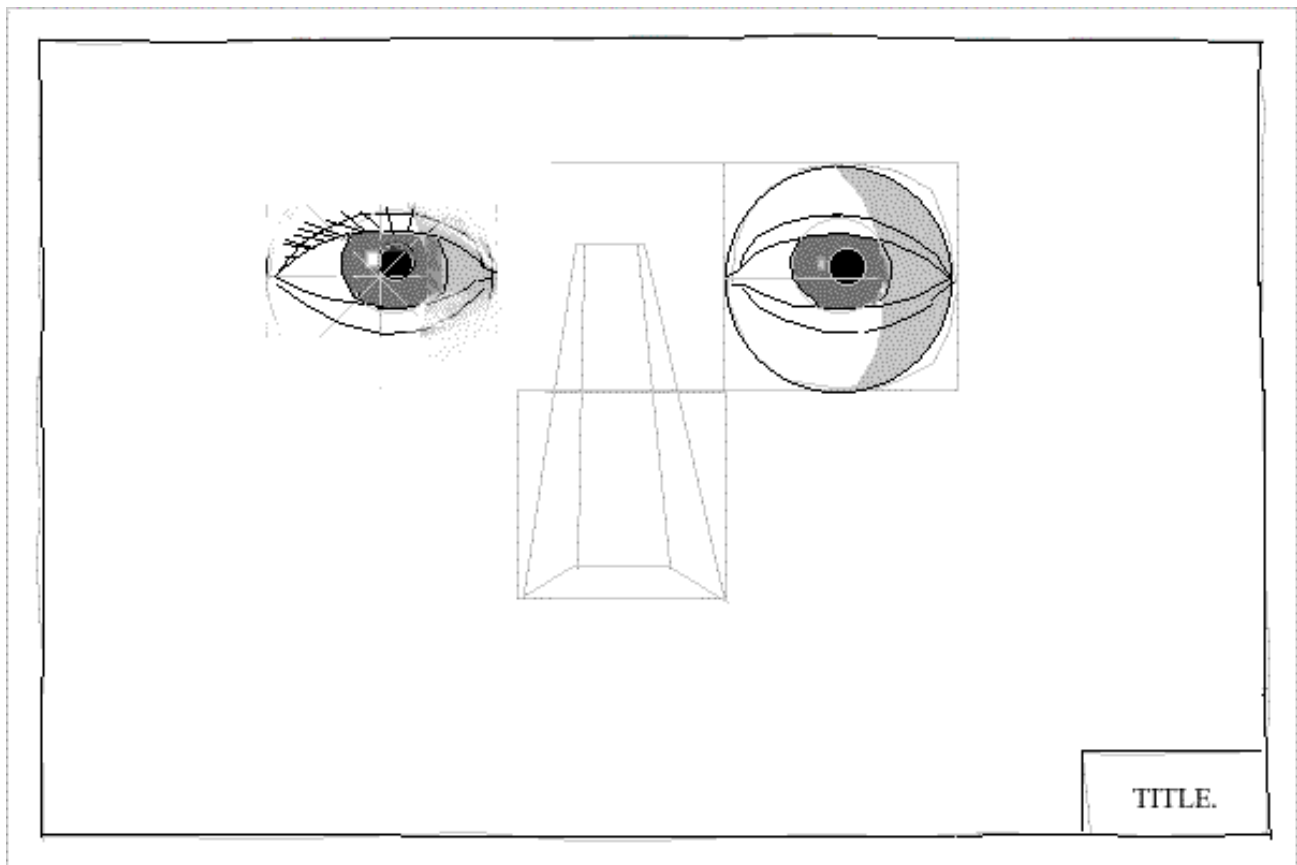

The 'length' of the nose will obviously differ between individuals ... but not too much. The distance between the eyes will often vary slightly as well but once you know the approximate distances as I have given you you can make the minor adjustments yourself.

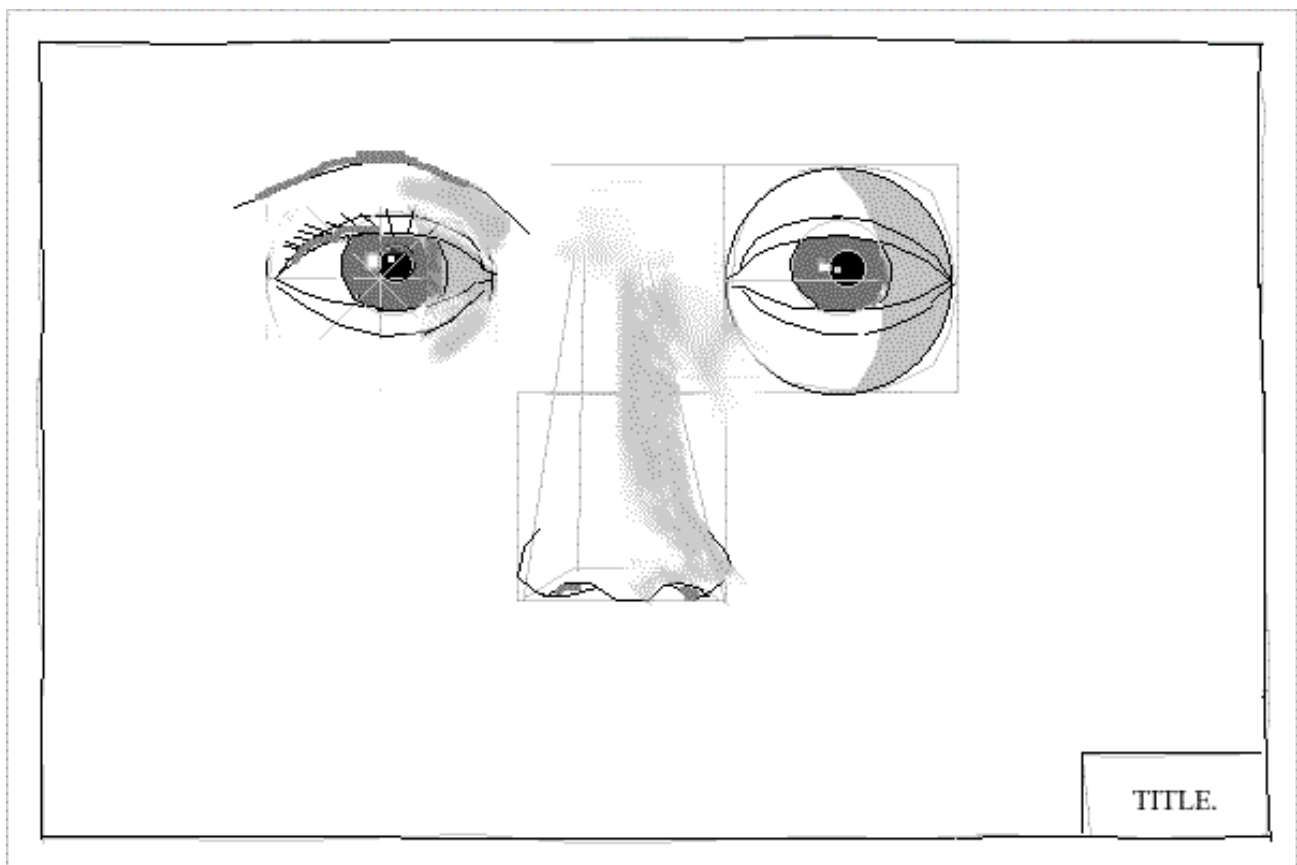

With a little shading and careful edges on the base of the nose you will be able to suggest the shape. Try not to include too many details at this stage. Next we will look at the lips ...

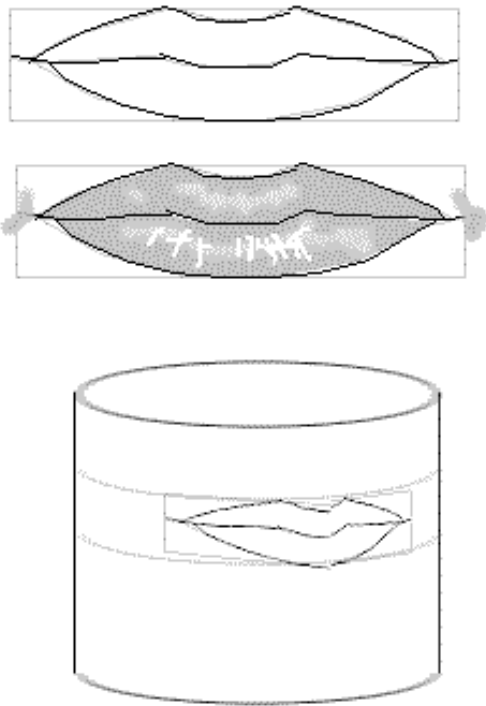

Lips are best visualized as part of a cylinder as they 'wrap around' the face. Here I have down the 'classic' shape with mouth closed. Using similar proportions construct your own as shown below.

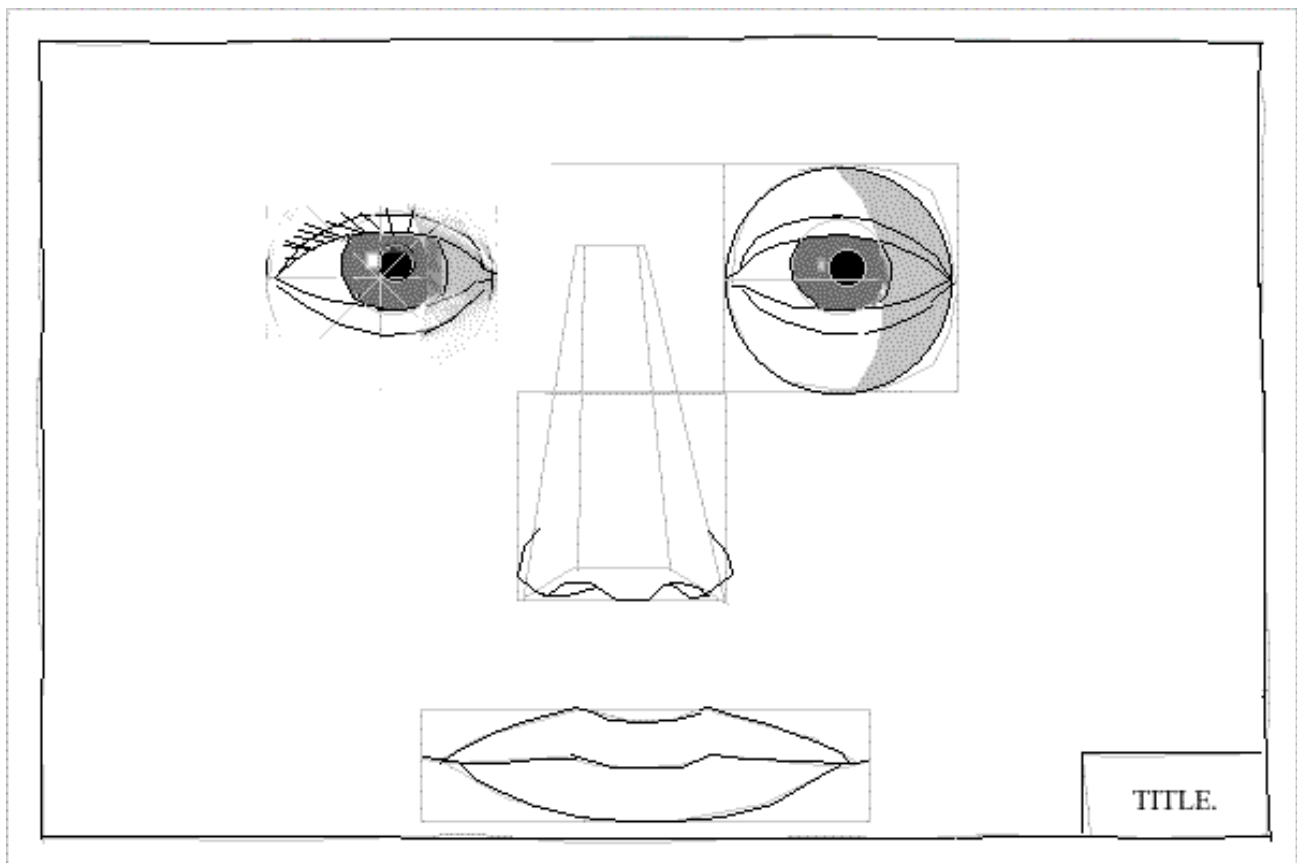

Now add a little bit of shading and complete your drawing as shown.

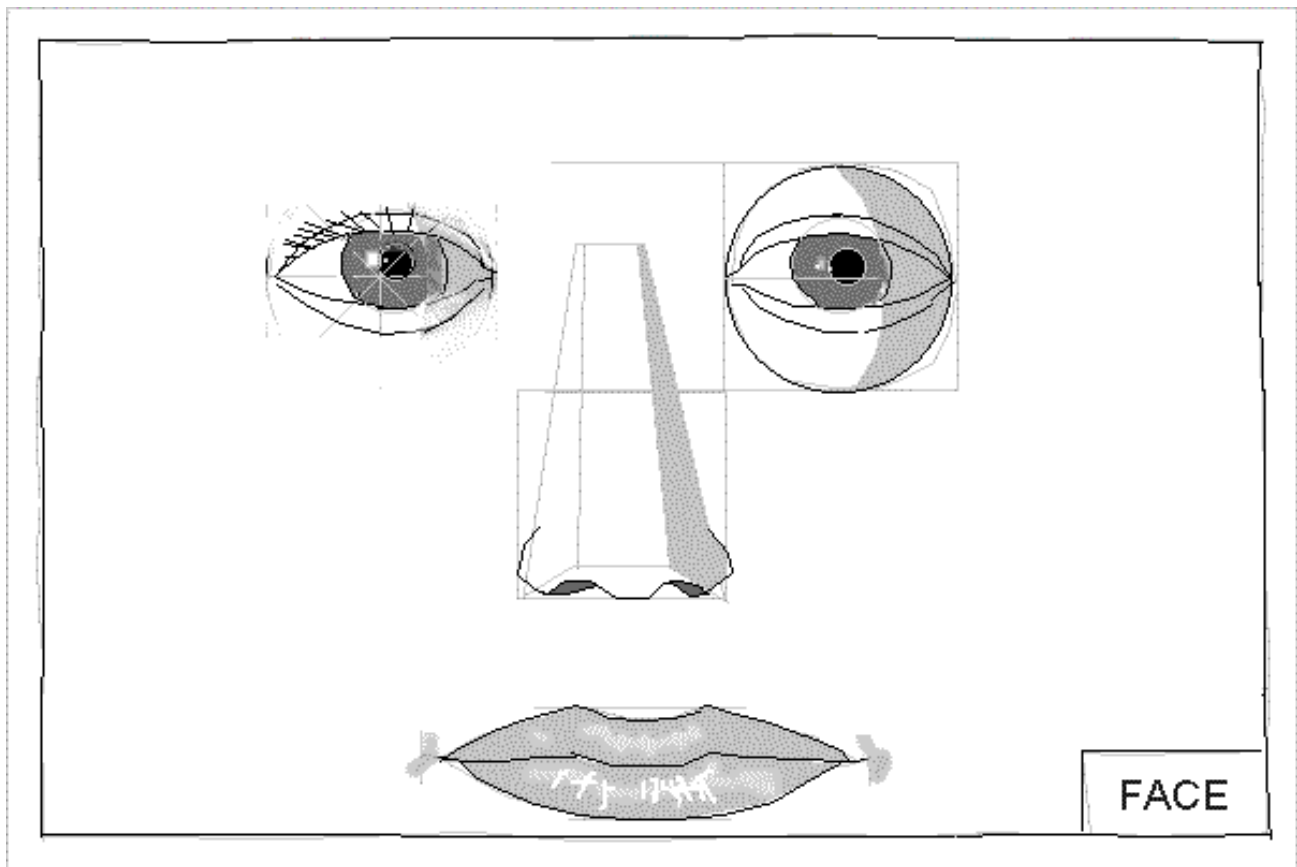

HOMEWORK

Complete both eyes and more shading.



[END OF DRAWING BOOK](#)

[back to start](#)

PART 2: LESSON - DRAWING A ROSE



TIME:

Allow 40min

Aim:

This is a project that has two parts. Part one, in this section, is learning to draw a rose and part two is in the general lesson section on making the drawing into a painting.

Materials;

The sketch pad, HB and 4B pencil, eraser.

In addition each student will need a single rose ... either have the student obtain one in preparation or the teacher might decide to provide them in which case one per every two students will be sufficient.

Allow five minutes to for the quick sketch test. Two minutes to do and three to mark. Swap, display and title if necessary.

You will need five sheets for this lesson but have the student prepare them as they need them.

Next have all the students examine the petals on their rose. They should take particular interest in the outside drooping petals where they will observe the following shapes. These they will draw as I have demonstrated below but with their own variations.

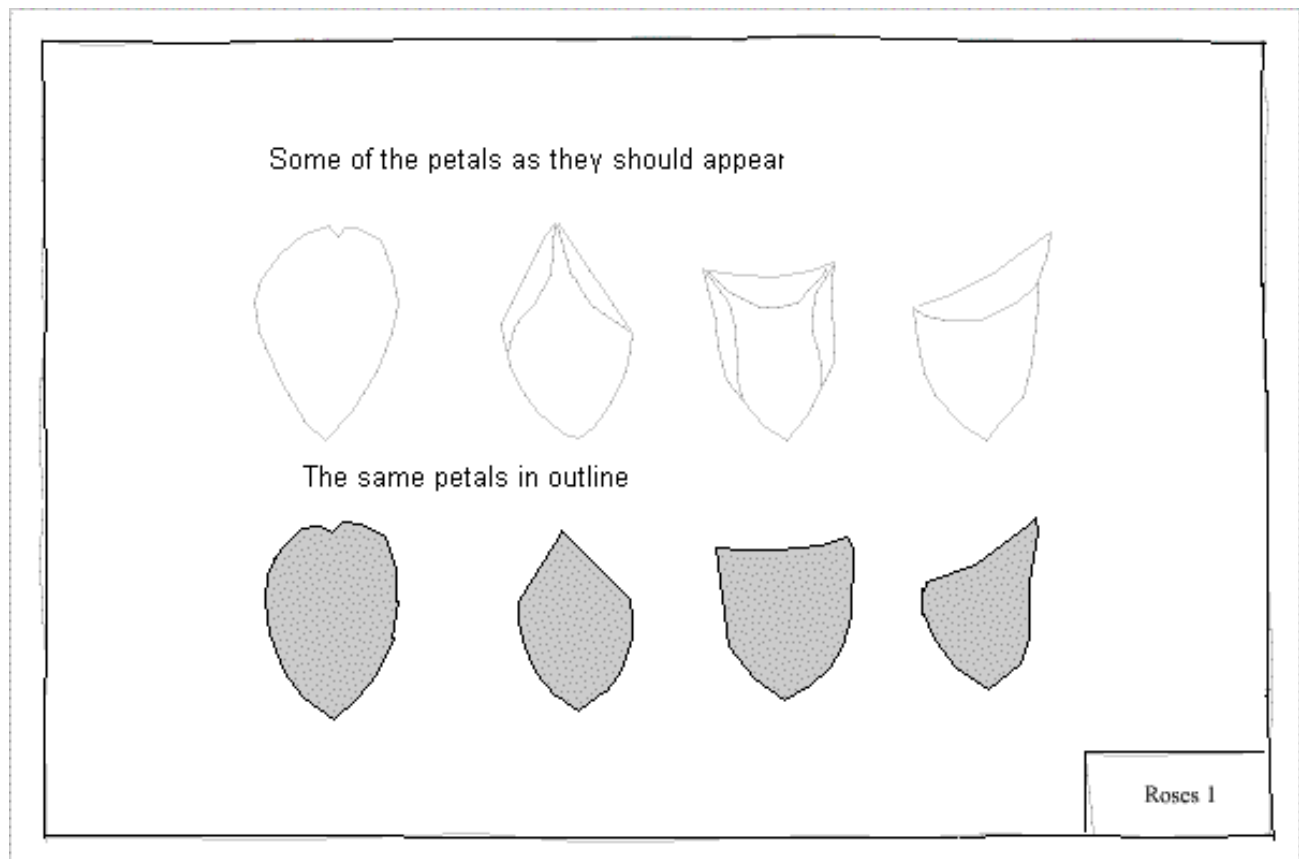

You will note that roses generally have five petals ... inside five petals - inside five petals etc. The petals are offset so that the outside petals don't line up with the adjacent row inside and so on and so forth. Therefore on the next sheet lightly draw a pentagon (five sided figure) as shown in Fig.1. You may use a circle if you like to be more accurate.

Nick the corners as I have shown in Fig.2

Put a vee in the flat sides of the pentagon as this will define the extent of the petals. Fig.3.

Firm in the outline as in Fig.4. as well as defining the petals and the center of the rose. You should now begin to understand the basic structure of the rose as seen from in front.

Complete and label the sheet.

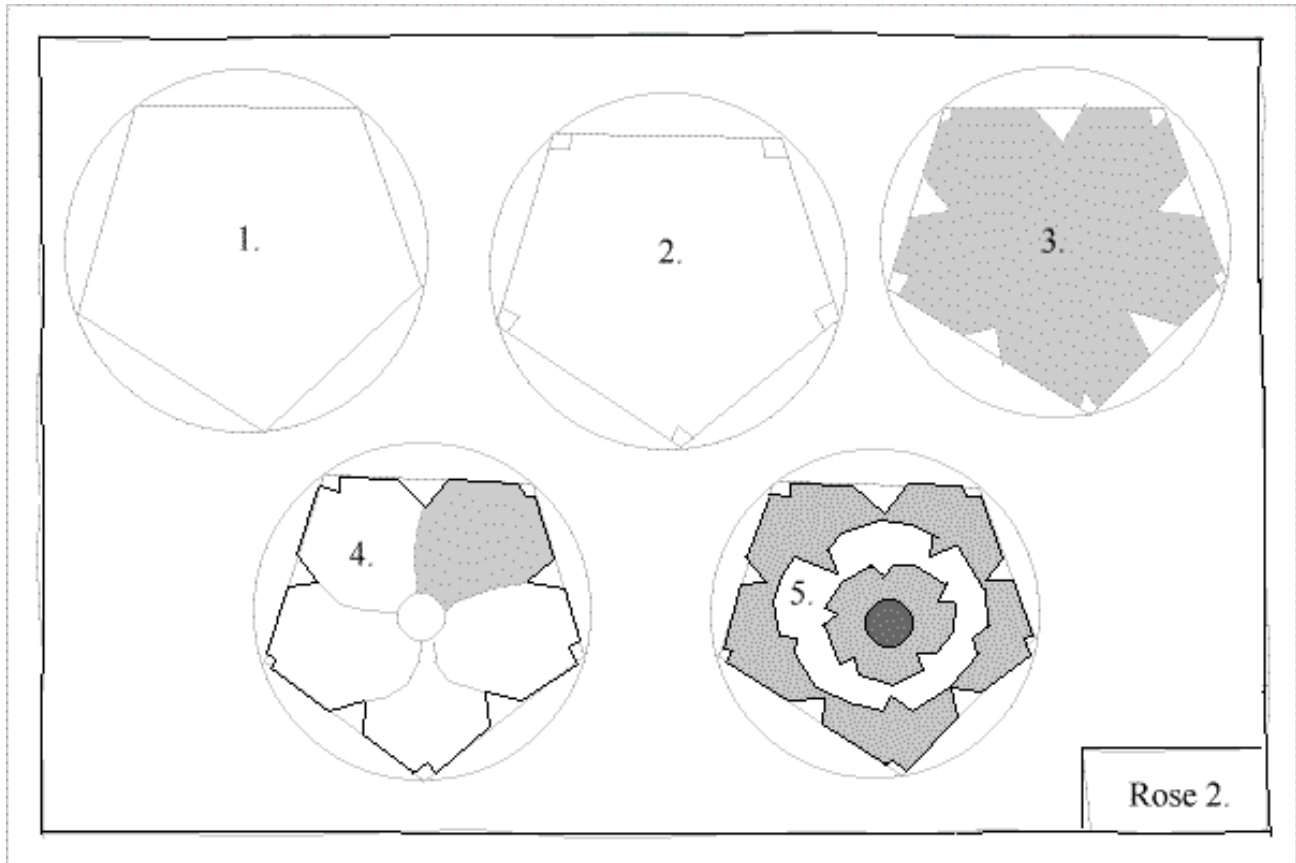

On a new sheet draw the rose as I have done taking particular care to vary the edges of the petals as you discovered in your drawing sheet No.1. Though the structure (pentagon) remains the same the outline gets varied as the petals fold over on themselves hence we get the irregular outline as in Fig.5.

In Fig.6 we will draw the classic 'bell shape' of the internal section of the rose as viewed from side on.

Fig.7 shows the 'bell shape' inserted into the outside petals.

Fig. 8 will be your sketch of the 'rosebud.' Label all these drawings and title the sheet.

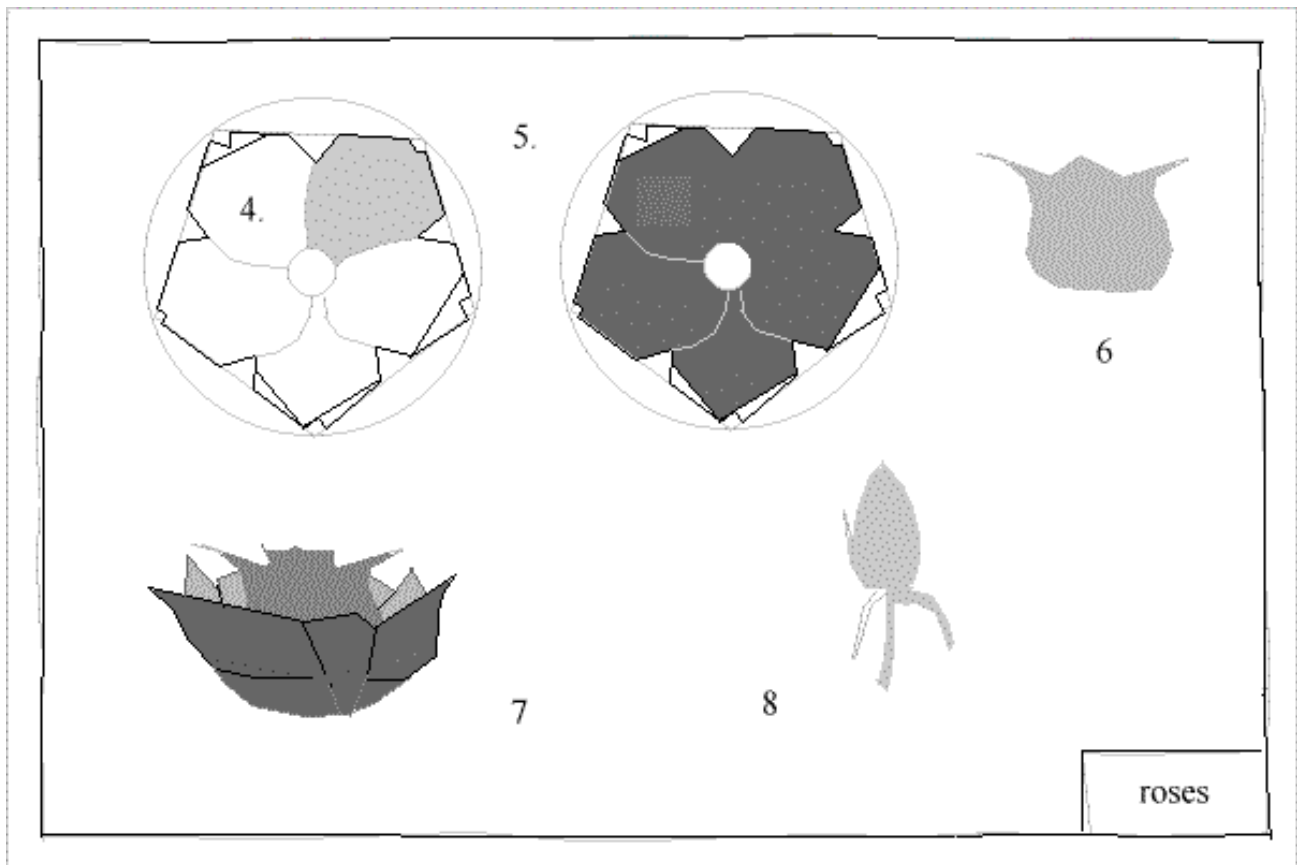

On the next sheet (below) we will draw the front view of the rose from the 'inside' out. Begin with the center as I have in Fig 1 and carefully construct your petals around it getting bigger as they spread out. Shade the deep parts of the petals as I have done until you have the complete 'reference sheet' similar to mine.

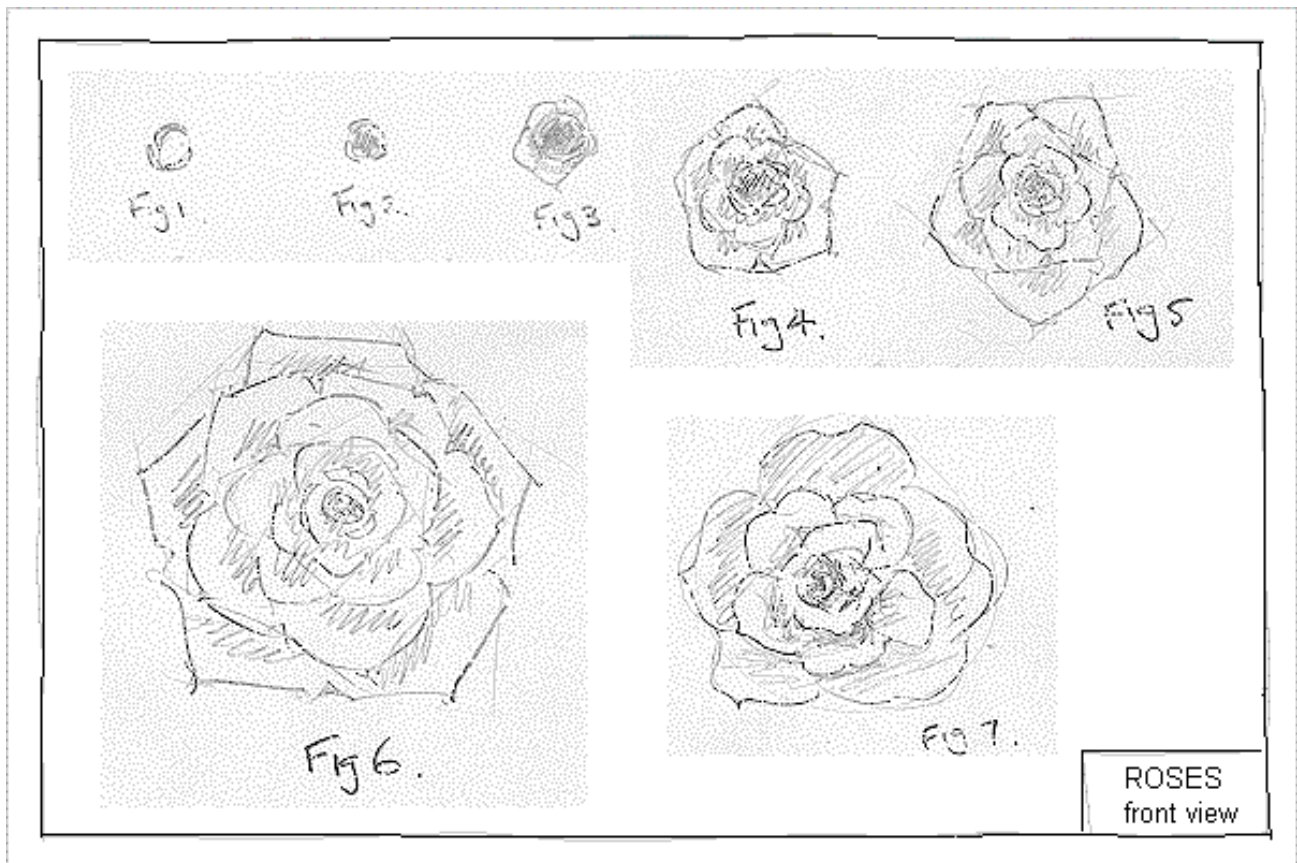

For our final reference sheet we will be drawing the petal again and forming it into side on views of the rose in semi and full bloom. Note the classic 'bell' shape and just concentrate on assembling all the petals. You will note you will only just see the tips of the inside petals though they will mostly appear flat on top as they curl over. They get smaller and stick up more as they get toward the

center of the rose.

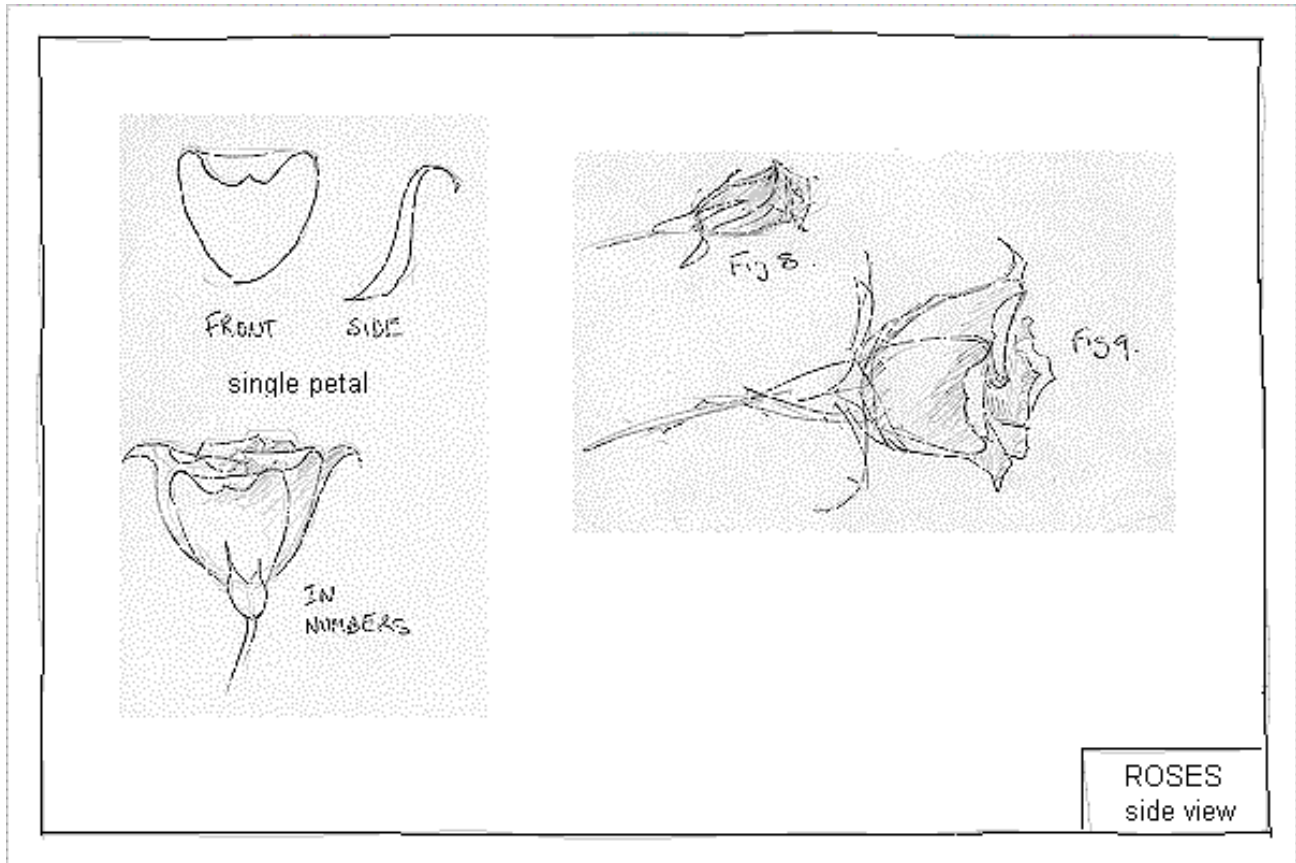

Please note the other 'parts' of the rose and add them as I have. Complete as shown above ... and add the title.

HOMEWORK

Observe and practice until you are comfortable drawing the rose from any angle. Try drawing it from the back!

For those students wishing to see how such a drawing can be converted into an oil painting depicting a vase of roses go to [painting roses](#) in the advanced lesson section.



END OF DRAWING BOOK

[back to start](#)
